

Reliability Considerations in Design and Use of RF Integrated Circuits

Prepared by: James Humphrey and George Luettgenau

ABSTRACT

Reliability is a major factor in the profitability of CATV Systems.

In spite of its proportionally low cost, the RF integrated circuit figures prominently in the overall reliability picture. This complex and important function is located at strategic points in the system.

Fortunately, modern design and manufacturing technology, which draws extensively from resources generated by military and space activities, assures a degree of reliability which is compatible with the most stringent requirements.

Transistor chips are the most vital elements of the RF integrated circuit. Low noise and distortion require state-of-the-art transistor structures. Gold metallization, thermal equilibrium by means of diffused balancing resistors, as well as automated process control have resulted in transistor lifetimes of over 100 years.

One of the inherent reliability advantages of IC's is the reduced number of interconnects. The full benefit of this characteristic is achieved through the use of gold conduction paths in conjunction with gold wire bonding. Perhaps the single most dangerous enemy of high reliability is excessive heat. Careful, computer-aided circuit design coupled with thermally sound, stress-free mechanical construction guarantee structural integrity and safe operating temperatures under all practical conditions. Infrared scanning helps verify the achievement of design goals.

Abuse or abnormal stresses may counteract the best of reliability. In order to avoid problems, the user must control the electrical, thermal, and mechanical environment surrounding the RF IC. Much progress in this respect has been made by the equipment industry.

INTRODUCTION

Reliability considerations are becoming increasingly important in the operation of CATV Systems, requiring an absorption of military and aerospace reliability technology into the CATV business. Market surveys show a large number of MSO's and consultants consider reliability as a major item in equipment selection.

A definition of major reliability terms is important along with an introduction to microcircuit reliability tools (both hardware and software).

An overview discussion of Physics of Construction involved with the die and interconnects must be presented.

DEFINITIONS

R = Reliability

Reliability is related to the probability that an item will perform a defined task satisfactorily for a specified length of time, when used for the purpose intended, and under conditions for which it was designed to operate.

Failure

Failure is a detected cessation of ability to perform a specified function within previously established limits in the area of interest.

- (a) Dead on arrival
- (b) Infant mortalities
- (c) Lifetime failure rates (random)
- (d) End of life (wearout)

MTBF (Mean Time Between Failures)

The total measured operating time of a population of equipment, divided by the total number of failures within the population during the measured period of time.

Average Life

The mean value for a normal distribution of lives, and generally, it applies to failures resulting from wearout.

BASIC RELIABILITY EQUATION

$$R = e^{-t/m} = e^{-\lambda t}$$

Where: R = Reliability or probability of success

t = Mission time in hours

m = MTBF in hours = hours/failures

λ = Failure rate = 1/MTBF = failures/hours

SYSTEM RELIABILITY

1 When components are in series, failure of any one of the components will result in failure of the system.

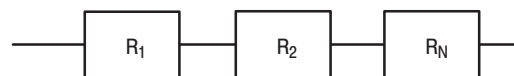

Then: $R_{SYSTEM} = R_1 \times R_2 \times R_3 \times \dots \times R_N$

$\lambda_{SYSTEM} = \lambda_1 + \lambda_2 + \lambda_3 + \dots + \lambda_N$



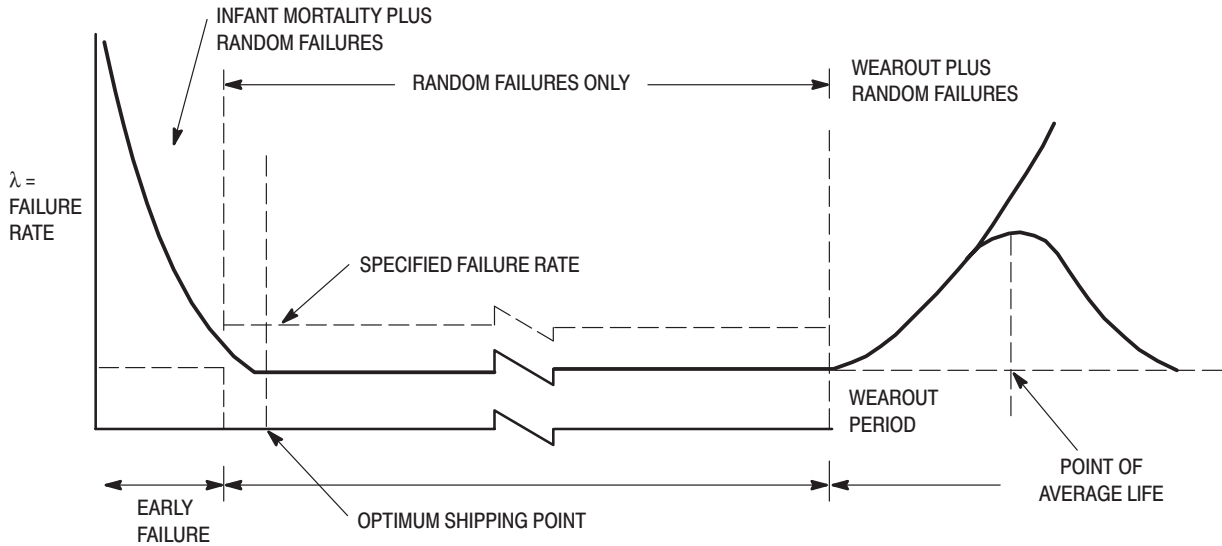

2 When the same components are in parallel (redundancy) neglecting, for simplicity, the decision-making device, the switchover function and the fail safe requirements:

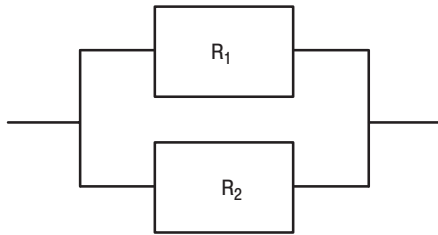

$$R_{SYSTEM} = R_1 + R_2 - (R_1 R_2)$$

RELIABILITY CURVE

The following curve represents the typical condition of operational reliability.

RELIABILITY PREDICTION ALGORITHM

The military has put considerable money and time into the study of reliability. One very useful military document is Military Handbook 217B, *Reliability Prediction of Electronic Equipment*. This handbook shows how to develop failure rate predictions by the use of mathematical models based on years of data collection by military agencies. A discussion of the interaction of components in the model is very understanding of the overall subject.

PART FAILURE RATE MODEL λ_p

- Where: λ_p = Part failures in failures per 10⁶ hrs.
 λ_b = Base failure rate
 π_T = Temperature adjustment factor
 π_E = Environmental adjustment factor
 π_Q = Adjustment factor based on quality
 π_F = Adjustment factor for circuit function
 = 0.8 for digital hybrids
 = 1.0 for linear hybrids
 = 1.1 for combination hybrids
 π_M = Adjustment factor for maturity of product

BASE FAILURE RATE MODEL λ_b

$$\lambda_b = \lambda_s + A_s \lambda_c + \sum \lambda_{RT} N_{RT} \text{ (Substrate contribution)} \\ + \sum \lambda_{DC} N_{DC} \text{ (Attached components contributions)} \\ + \lambda_{PF} \pi_{PF} \text{ (Package contributions)}$$

- Where λ_b = Base failure rate in failures/10⁶ hr.
 λ_s = Failure rate due to the substrate and film processing
 $A_s \lambda_c$ = Failure rate contributions due to network complexity and substrate area which includes:
 (a) Number of lead terminations
 (b) Number of film resistors
 (c) Number of discrete chip devices
 (d) Type of film (thin versus thick)
 $\sum \lambda_{RT} N_{RT}$ = The sum of the failure rates for each resistor as a function of the required resistance tolerance
 $\sum \lambda_{DC} N_{DC}$ = The sum of the attached device failure rates for semiconductors and capacitors
 $\lambda_{PF} \pi_{PF}$ = The hybrid package failure adjusted to include material and style

PHYSICS OF CONSTRUCTION

Following the enumeration and identification of symbols used in reliability algorithms, a discussion of the major microelectronic components with respect to their reliability contributions is in order:

TRANSISTORS

The transistor die is the heart of the hybrid amplifier. With four to eight devices per circuit, the transistor determines performance and is most critical to proper circuit operation. During the last few years users have witnessed major advances in the performance of linear broadband transistors. Often, efforts to improve one characteristic have adverse effects on other desirable features. For instance, distortion may be bettered by thinning the epitaxial collector region. This, however, leads to sensitivity to voltage transients and other abnormal operating conditions. Therefore, devices with outstanding performance in one area are prone to weakness in others. Computer-aided device design coupled with

volume production and tight process controls have resulted in transistors in which all essential features are in proper balance.

High f_T is generally recognized as an important factor in achieving wide bandwidth and uniform distortion characteristics. Gigahertz transistors, which are now being used, have very delicate patterns, involving micron and submicron tolerances. They also occupy sizable areas on the silicon wafer, since watt-sized powers have to be handled. It is only realistic to expect that all parts of the overall transistor structure are not perfectly alike, but rather resemble the parallel configuration of many, slightly differing, small devices, as shown in the figure.

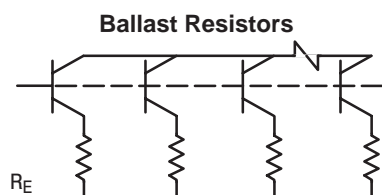

It is also apparent that the entire transistor geometry cannot be tightly thermally coupled within itself, therefore giving rise to the possibility of small sub-areas of the transistor assuming different values of temperature than others. This possible problem can be effectively combatted by adding emitter balancing resistors to the device. Ideally each emitter-site or finger should have its own resistor. This goal is easily realized in interdigitated structures. Film or diffused monolithic resistors may be used. From a process and reliability point of view, diffused resistors are preferred because they avoid the silicon-oxide barrier which has a very high thermal resistance.

METAL MIGRATION

Some time ago a serious failure mechanism, associated with GHz transistors, was discovered. The metallization stripes of such devices, as mentioned earlier, are only a few microns wide. The metal thickness is, because of fabrication limitations, of similar dimensions. Consequently, the current density in these stripes is quite high, often reading hundreds of thousands of amperes per cm^2 of cross-section. Under these circumstances, metal migration may occur. With such large numbers of electrons flowing in such crowded space, the probability of collisions with thermally activated metal ions is great. The ions are propelled in the direction of electron current flow causing, in the long run, the metal to move, forming hillocks, whiskers and voids. The lifetime of a transistor is a function of three things: the current density, the temperature, and the type and consistency of metallization.

Diffused Ballasting System (Only one emitter contact shown)

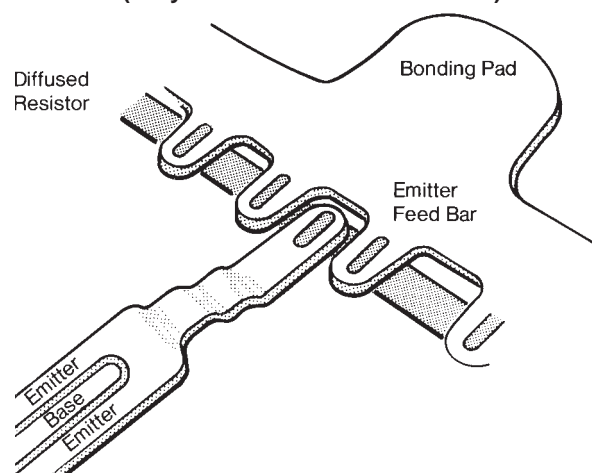

Metal Film Ballast Resistor

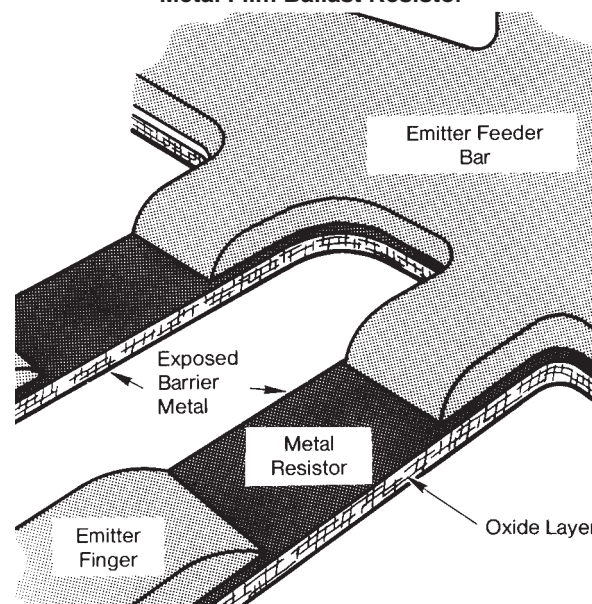

Not much leeway exists in reducing the current density (unless f_T is sacrificed). Changing from aluminum to gold extends the life at least by an order of magnitude. At high temperatures the difference is even more pronounced. At 150°C , the time to metal failure for gold metallization microwave transistors is in excess of 10^6 hours = 114 years. While this number is quite comforting, one is not at liberty to treat the subject of transistor chip heatsinking too lightly. A proven method for removing heat while at the same time obtaining a solid mechanical mount, has been to employ a heatspreader between the silicon chip and the IC substrate. Automatic mounting stations are used to eutectic collet mount the chip to indexed leadframes. Tight control of pressure and scrub sequence result in defect free attachment. Although one may employ other methods of heatsinking, e.g. beryllium oxide substrates for part of the circuit, the added mechanical complexity and the reduced freedom of optimal circuit layout presently outweigh the minor advantages resulting from a reduction in transistor temperature.

AN1025

INTERCONNECTS

One of the most important parts of hybrid circuits is the interconnect system. The ability to reduce the number, control the quality, and test them by screening complete functions, is one of the major advantages of hybrid circuits over more conventional approaches. Constant improvement in the mechanical and metallurgical systems have drastically improved reliability.

An analysis of the schematic on the standard 33 dB Hybrid Amplifier will illustrate the point:

Comparing hybrid versus discrete techniques, one can show the following:

- 1 For each transistor used, a minimum of three interconnects corresponding to the solder joints at the PC board are eliminated.
- 2 For each capacitor used, a minimum of two interconnects are eliminated.
- 3 For each film resistor used, a minimum of four interconnects are eliminated corresponding to the connection to the resistor body and the connection to the PC board.
- 4 Transformer interconnects will be the same for hybrid or discrete.

The increase in interconnects in building 33dB of gain in discrete form over the same circuit in hybrid form is:

Add due to transistors	=	24
Add due to chip capacitors	=	12
Add due to resistors	=	100
Add due to transformers	=	0
Less due to hybrid jumpers	=	-4
Less due to active pins	=	-5
		127 Additional interconnects per 33 dB function

MIL Handbook 217B also discusses the reduction in reliability of printed circuit boards as a direct multiple of the holes required. Eighty-one additional holes are involved in making one discrete amplifier.

33 dB Gain Block

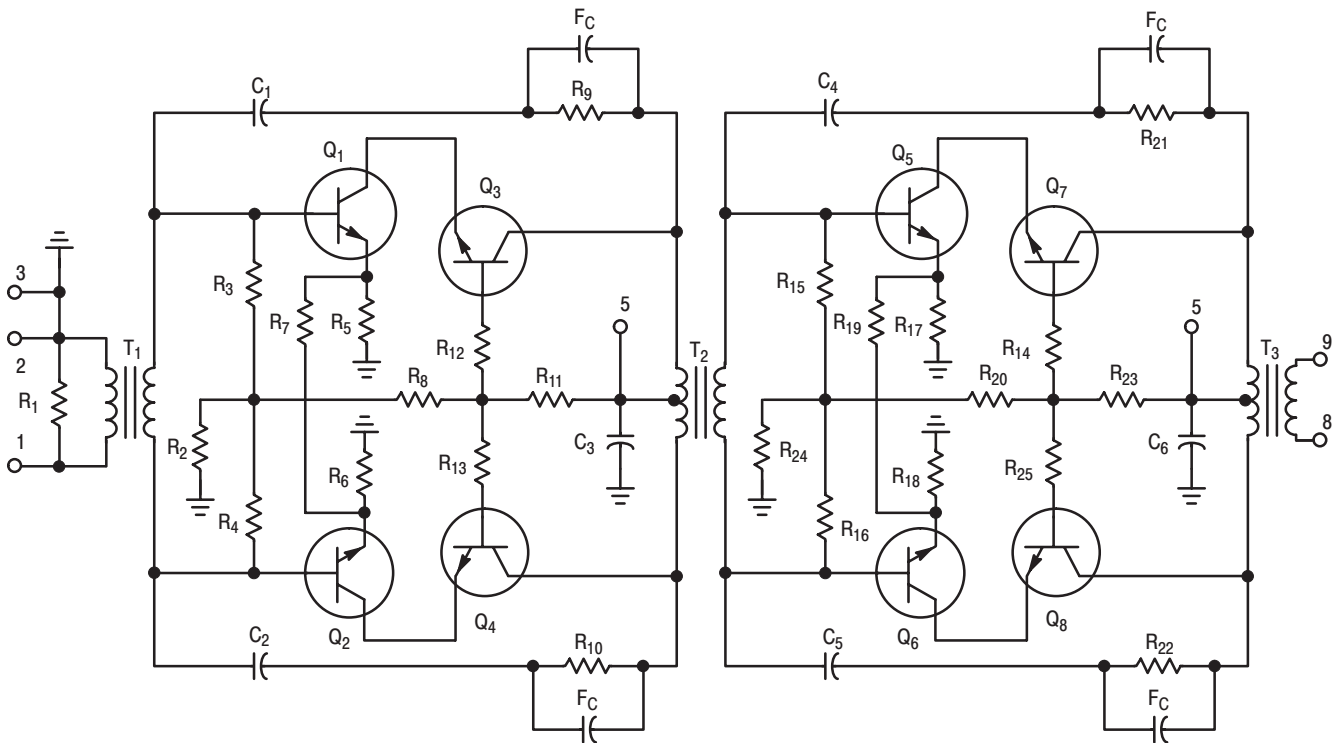

Having the interconnects made early in the manufacturing sequence, before the subsequent series of tests and inspections, has beneficial influence on end equipment reliability.

The complete functional system including interconnects is tested, screened and Q.C. sampled many times before it even meets up with the PC board in the manufacturers subsystem .

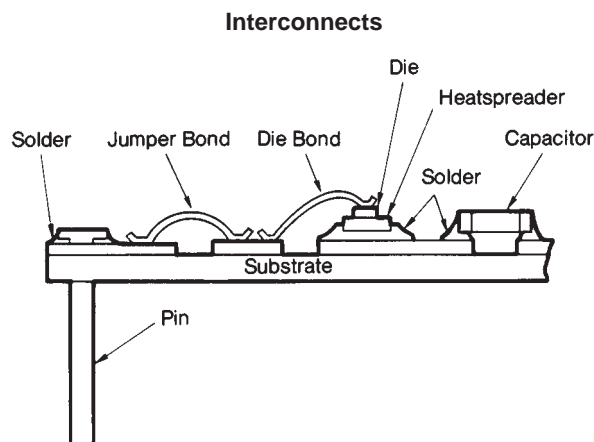

COMPONENT MOUNT

The transistor heatspreaders, chip capacitors and pin connections are soldered to the metallization pattern on the substrate surface. This process is completed in a tightly controlled solder reflow furnace.

Due to the fact that the units are processed in an inert atmosphere and thoroughly cleaned and inspected early in the production process, workmanship problems are greatly reduced.

BONDS

Wire bonding was a major reliability issue for years.

Aluminum has been one of the most widely used bonding systems in the hybrid industry for many years. The main reason for this is that ultrasonic aluminum systems bond at room temperature and, hence, do not interfere with other hybrid assembly processes.

Gold thermal compression ball bonding has been a reliable standard process in the semiconductor industry for years. However, the requirement for 300°C bonding temperatures have kept this technique out of most hybrids. The recent changeover to all gold hybrids prompted the development of a compatible low temperature gold wire bonding system which by far out-performs aluminum.

Advantages of Aluminum Bonds

- Low temperature process
- Compatible with Al die metal
- Low cost
- High speed
- Easy to loop (stiff)

Disadvantages of Aluminum Bonds

- Degrades with time/temperature
- Kirkendall voiding

- Intermetallic formation with gold
- Brittle and subject to cracks
- Difficult to screen
- Difficult to control

Advantages of Gold Bonding

- Compatible with gold die and substrate
- Strength stable with time/temperature
- Malleable-not subject to cracking
- Easier to control process

Disadvantages of Gold Bonding

- More expensive
- More deformation at bond foot
- Hard to form loops

Histogram of Gold Versus Aluminum Bond Strengths

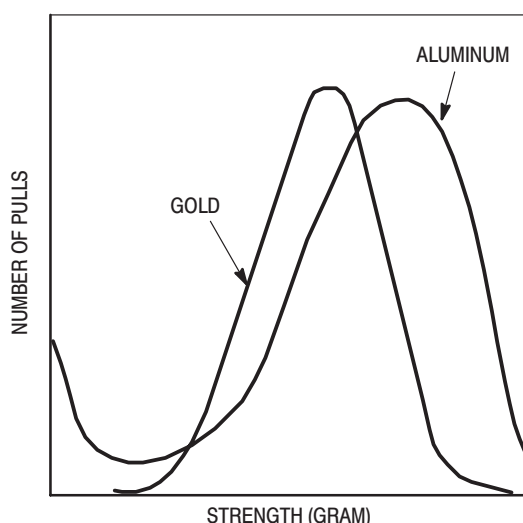

Strength Versus Time on Gold Versus Aluminum Wire

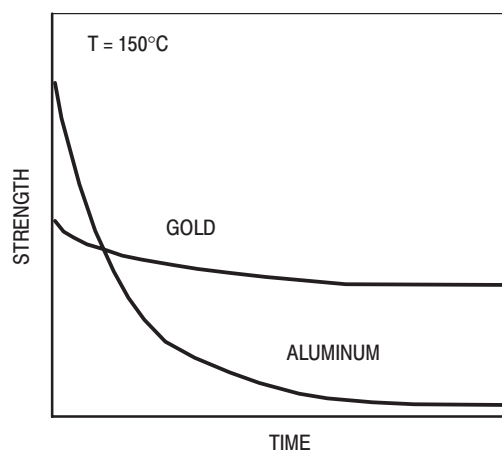

RELIABILITY ADJUSTMENT FACTORS

Following is a discussion of the "π adjustment factors" in MIL Handbook 217B. These relate to the external influences on hybrid circuit reliability.

AN1025

TEMPERATURE ADJUSTMENT FACTOR π_T

Operating temperature is one of the most important factors in reliability. As can be seen by the curve shown, great reliability improvements can be obtained by lowering the case temperature.

Failure Rate Multiplier Due to Temperature

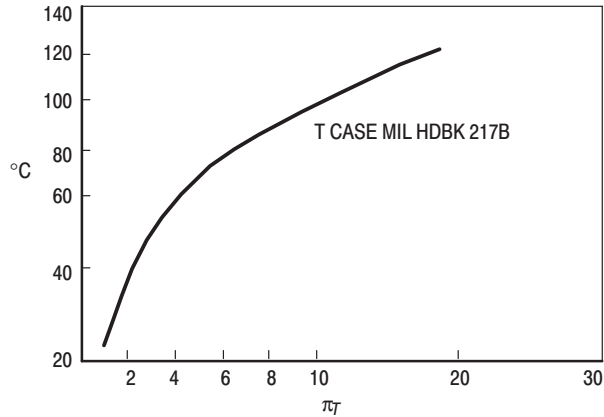

This curve shows that a hybrid circuit, operating at a case temperature of 100°C, has four times the failure rate as the same circuit run at 50°C.

ENVIRONMENTAL ADJUSTMENT FACTOR π_E

This adjustment factor is based on the service environmental conditions that the part will be exposed to during operation.

π_E , Environmental Factor Based on Environmental Service Conditions

Environment	Symbol	π_E
Ground, Benign	G_B	0.2
Space Flight	S_F	0.2
Ground Fixed	G_F	1.0
Airborne, Inhabited	A_I	4.0
Naval, Sheltered	N_S	4.0
Ground, Mobile	G_M	4.0
Naval, Unsheltered	N_U	5.0
Airborne, Uninhabited	A_U	6.0
Missile, Launch	M_L	10.0

MATURITY ADJUSTMENT FACTOR π_M

The failure rate predicted by this mechanical model can be expected to increase by a factor of ($\pi_M = 10$) under any one of the following conditions:

- New device in initial production.
- Where major changes in design or processes have occurred.
- Where there has been an extended interruption in production or a change in line personnel (radical expansion).

The factor of 10 can be expected to apply until conditions and controls have stabilized. This period can extend for as much as 6 months of continuous production.

This maturity factor is extremely important. The industry has used over 400,000 CATV modules since the first module was shipped in 1970. Since that time we have constantly improved and refined the IC. Optimum reliability is an evolutionary process depending on time, volume, defect analysis and feedback to fine tune the product and eliminate defects.

The question is where does CATV fit into this table. Mechanical and thermal casting designs are extremely important in protecting the RF IC from the external environment conditions. Still, wide variations in system placement introduce a swing factor for environmental effects, which will cause π_E for CATV to fall between 1.0 and 5.0.

The user must strive to keep the components as close to laboratory zero as possible.

QUALITY ADJUSTMENT FACTOR π_Q

This is the adjustment factor based on the quality grade of the product. This factor modifies the reliability levels by the different quality levels specified in MIL STD 883, *Test Methods and Procedures for Microelectronics*. These levels take into account different screening levels, qualification levels and quality conformance inspection requirements for the specified class.

	π_Q
MIL STD 883 Class A	0.5
MIL STD 883 Class B	1.0
Vendor Equivalent Class B	5.0
MIL STD 883 Class C	30.0
Commercial with Screening	50.0
Commercial (No Screening)	75.0

A study of the MIL STD 883 Quality Requirements allow a very important discussion of cost versus reliability. As could be expected the test, manpower, equipment, time and paperwork go up rapidly as the MIL STD Grade is increased. A relative plot of this relationship is shown below:

Cost Versus Reliability

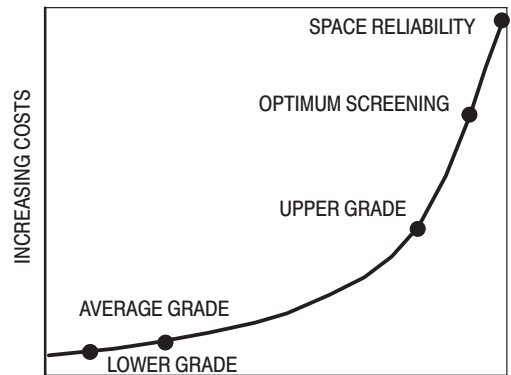

Many of the MIL Standard Military requirements seem unimportant in influencing CATV reliability. However, the cost versus reliability curve is real and the equipment supplier can make choices as to the type of reliability he is willing to pay for.

EQUIPMENT

It takes a massive capital investment in order to meet the manufacturing requirements for the CATV industry. The

volume, quality and performance standards required have caused us to constantly reinvest for the future. Many of the invested dollars are for equipments for which the return on investment is subjective.

SCANNING ELECTRON MICROSCOPE

This instrument allows very high magnification of surface conditions not available with optical methods. Magnifications up to 100,000 times are possible with the SEM.

DISPERSIVE X-RAY ANALYSIS

This capability, which is a feature of the SEM, allows us to make a microprobe to determine the chemical composition of a sample. This is accomplished by detection of secondary emission x-rays which possess characteristic energies. The relative quantity and location of elements may then be displayed on the CRT.

VARIABLE FREQUENCY VIBRATION

This is a destructive test which is performed for the purpose of determining the effect on component parts of vibration in the specified frequency range.

X-RAY

This is a very valuable tool for detecting voids in solder or eutectic bonds.

INFRARED MICROSCOPY

The ability to examine a circuit thermally under operating conditions is absolutely necessary when designing a new product or testing a new process. The infrared microscanner is used for evaluation of new products from the standpoint of thermal resistance and operating temperature. Resolution of 0.0005 inch can be achieved.

CONCLUSIONS

- Many reliability tools are available today both in equipments for evaluation of reliability and in analytical

tools such as MIL Handbook 217B for predictions of reliability.

- Hybrid circuits offer massive reliability leverage due to:
 - (a) Reduction of Interconnects
 - (b) Ability to control quality by screening
 - (c) Large volume of complex standard functions are easier to control
- Case temperature is very important for reliability.
- A monometallic system, i.e., gold die metallization and gold wire bonding are optimum for reliability.
- Reliability can be improved by adding quality cost to the module process. This increased cost may easily be returned due to the lower failure rate.

ACKNOWLEDGEMENTS

The authors wish to thank Al Bird, TRW Systems Group, Redondo Beach, California, for his technical guidance.

REFERENCES

- 1 MIL Handbook 217B, *Reliability Prediction of Electronic Equipment*.
- 2 MIL Standard 883, *Test Methods and Procedures for Microelectronics*.
- 3 MIL Handbook 175, *Microelectronic Device Data Handbook*.
- 4 M. Flahie, "Reliability and MTF — The Long and Short of It," *Microwaves*, July 1972.
- 5 R.Y. Scapple and F.Z. Keister, "A Simplified Approach to Hybrid Thermal Design," *Solid State Technology*, October 1973.
- 6 J.R. Black, "Electromigration Failure Modes in Aluminum Metallization for Semiconductor Devices," *Proceedings of the IEEE*, Volume 57, Number 9, September 1969.
- 7 C.M. Ryerson, S.L. Webster, F.G. Albright, "RADC Reliability Notebook Volume II," *RADC-TR-67-108*, September 1967.
- 8 George G. Luetzgenau, "Microwave Power Transistors," International Microwave Conference, Stockholm, 1972.

Motorola reserves the right to make changes without further notice to any products herein. Motorola makes no warranty, representation or guarantee regarding the suitability of its products for any particular purpose, nor does Motorola assume any liability arising out of the application or use of any product or circuit, and specifically disclaims any and all liability, including without limitation consequential or incidental damages. "Typical" parameters can and do vary in different applications. All operating parameters, including "Typicals" must be validated for each customer application by customer's technical experts. Motorola does not convey any license under its patent rights nor the rights of others. Motorola products are not designed, intended, or authorized for use as components in systems intended for surgical implant into the body, or other applications intended to support or sustain life, or for any other application in which the failure of the Motorola product could create a situation where personal injury or death may occur. Should Buyer purchase or use Motorola products for any such unintended or unauthorized application, Buyer shall indemnify and hold Motorola and its officers, employees, subsidiaries, affiliates, and distributors harmless against all claims, costs, damages, and expenses, and reasonable attorney fees arising out of, directly or indirectly, any claim of personal injury or death associated with such unintended or unauthorized use, even if such claim alleges that Motorola was negligent regarding the design or manufacture of the part. Motorola and  are registered trademarks of Motorola, Inc. Motorola, Inc. is an Equal Opportunity/Affirmative Action Employer.

Literature Distribution Centers:

USA: Motorola Literature Distribution; P.O. Box 20912; Phoenix, Arizona 85036.

EUROPE: Motorola Ltd.; European Literature Centre; 88 Tanners Drive, Blakelands, Milton Keynes, MK14 5BP, England.

JAPAN: Nippon Motorola Ltd.; 4-32-1, Nishi-Gotanda, Shinagawa-ku, Tokyo 141, Japan.

ASIA PACIFIC: Motorola Semiconductors H.K. Ltd.; Silicon Harbour Center, No. 2 Dai King Street, Tai Po Industrial Estate, Tai Po, N.T., Hong Kong.