

# vyö

## Frequency Reuse How Do I Maximize the Value of My Spectrum?

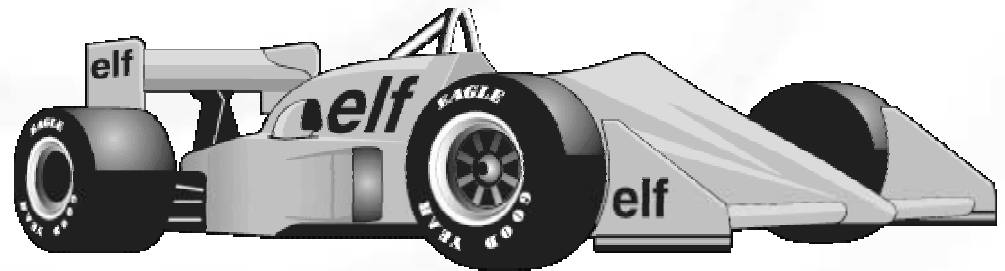
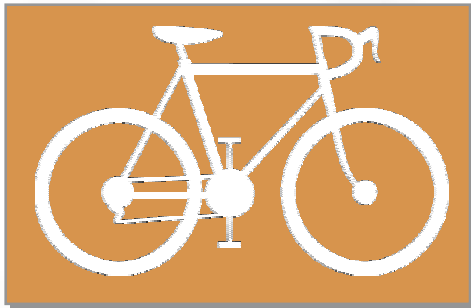

Eric Wilson  
VP Systems Management, Vyö

Broadband Wireless Forum, February 20, 2001

# Spectrum Reuse Outline

---

- Definition / concept
- Alternatives to consider
- Problems to address
- Solutions and tradeoffs
- Migration paths
- What does the future hold?

# Definition: Spectrum Reuse

---

- Reuse is a figure of merit for the relative efficiency of a cell cluster plan
- $(\text{Bandwidth used in a cell}) / (\text{Bandwidth available to system})$
- Hold over from the cell phone planners
  - Modulation optimized for phone battery life
    - Not spectrum efficient
    - All active users occupy equal bandwidth
- We need to consider the total data bandwidth in a territory --- which includes the modulation type
  - bits/second/Hz/(square km)

# Spectrum Reuse

## Why do we want it?

---

- Spectrum, frequencies, channels, bands ... are limited in availability
  - Everyone wants the good ones
- Maximize the use of what we have
  - Reliable connectivity
  - More subscribers per area
    - More subscribers per channel
  - Optimal throughput
    - More traffic per Hz of allocated spectrum per square km

# Spectrum Reuse Depends Primarily on:

---

- Base Station
  - Antenna Patterns
  - Antenna tower heights and tilt
  - Base Station Locations – roof / tower rights
  - Transmitter and receiver linearity
  - Modulation complexity
- CPE
  - Installation proofing process
  - Antenna Patterns
  - Antenna mounted heights
  - Transverter linearity

# Vyyo's Products

---

- Wireless Modems
- Wireless Modem Termination System
- Network Management

Not Antennas or Towers!

# Users Want Connectivity

## and don't care about the details

---

- Vyyo's Wireless Modem provides:
  - Multiple band support
    - UHF, MDS, WCS, ITFS, MMDS, 3.5, and LMDS
  - Multiple modulations
  - Multiple symbol rates
- Vyyo's base station WMTS provides:
  - Modular design
  - Field expandability
- Products designed with flexibility
  - Omni to 24 sector antennas
  - Single "Big Stick" to dozens of micro-cells

# Degrees of Freedom

---

- Antennas
  - Pattern
  - Polarity
- Modulation
  - Determines SNR required
- MAC enhancements
  - ARQ, FEC
- Cell Plan
  - Distance, number of sectors, number of cells



# Constraints

---

- Spectrum
- Signal to Interference and Signal to Noise Ratios
- Aesthetics
- Costs

All balanced to achieve the best cost per M bps throughput in the spectrum that is available

# Disclaimers

---

- Generally talking about Line-of-Sight Frequencies
  - Near LOS, Challenged LOS, and Non-LOS issues are not addressed in this paper
- Bits per Hertz are all gross numbers
  - Forward Error Correction (FEC), Acknowledge Request (ARQ), overheads are not considered in this paper
- Signal-to-Noise and Signal-to-Interference are considered to be the same issue (licensed bands)
- Signal-to-Noise Ratios (SNR) shown are conservative levels

# Disclaimers (continued)

---

- Any real system deployment has many aspects which need to be simultaneously considered
  - Terrain and population distribution
  - Customer profile and traffic patterns
  - Business model and objectives
  - Spectrum and roof top availability
- Employ a real systems engineer during your system planning phase
  - RF, networking, logistics, mechanical, power

# Modulation Requirements

---

- Modulation determines isolation required
  - QPSK (2 b/Hz) requires > 12 dB SNR
  - 16 QAM (4 b/Hz) requires > 18 dB SNR
  - 64 QAM (6 b/Hz) requires > 25 dB SNR
- Isolation between cells provided primarily by
  - Distance – free space loss
  - Alternate polarity in adjacent cells
  - Antenna tilt, earth curvature and terrain

# Isolation

---

- Isolation is required to prevent interference from other cells and from other sectors in the same cell which are using the same frequency.
- Isolation between sectors may be achieved by selection of the required antenna pattern
- Isolation between cells is determined by the cell plan
  - Sectors
  - Polarization
  - Frequency

# Two Deployment Scenarios

---

- Existing “Super Cell”
  - Add sectors
  - Fill in with small cells
    - Omni cells
    - Sectorized cells
- New, multiple cell deployment
  - Omni cells
  - Sectorized cells

# Distance is Isolation

- Attenuation =  $20 \cdot \log(\text{distance})$

Distance (ratio)	Isolation (dB)	Modulation Acceptible
2	6	
3	10	
4	12	
5	14	QPSK
8	18	16 QAM
17	25	64 QAM

Path loss at 3.5 GHz

KM	dB
0.5	97
1	103
2	109
5	117
10	123

# Co-Channel Interference

---

- Interference which is in the same band as the desired signal
  - Therefore, demodulator can't use frequency to differentiate
- Polarization increases isolation
  - Frequency, distance and environment dependent
    - 8 to 20 dB improvement
      - Count on 8 dB

Distance (ratio)	Attenuation with Polarization	Modulation supported
2	14	QPSK
3	18	16 QAM
7	25	64 QAM



# Spectrum Allocations / Omni Antenna

---

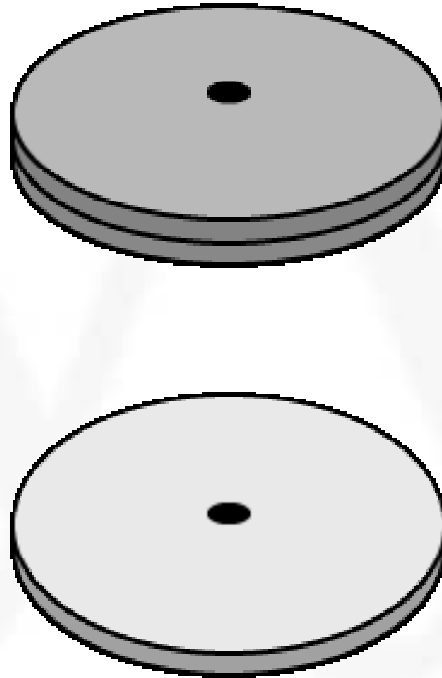

# Typical Block Diagram Omni Down & Upstream

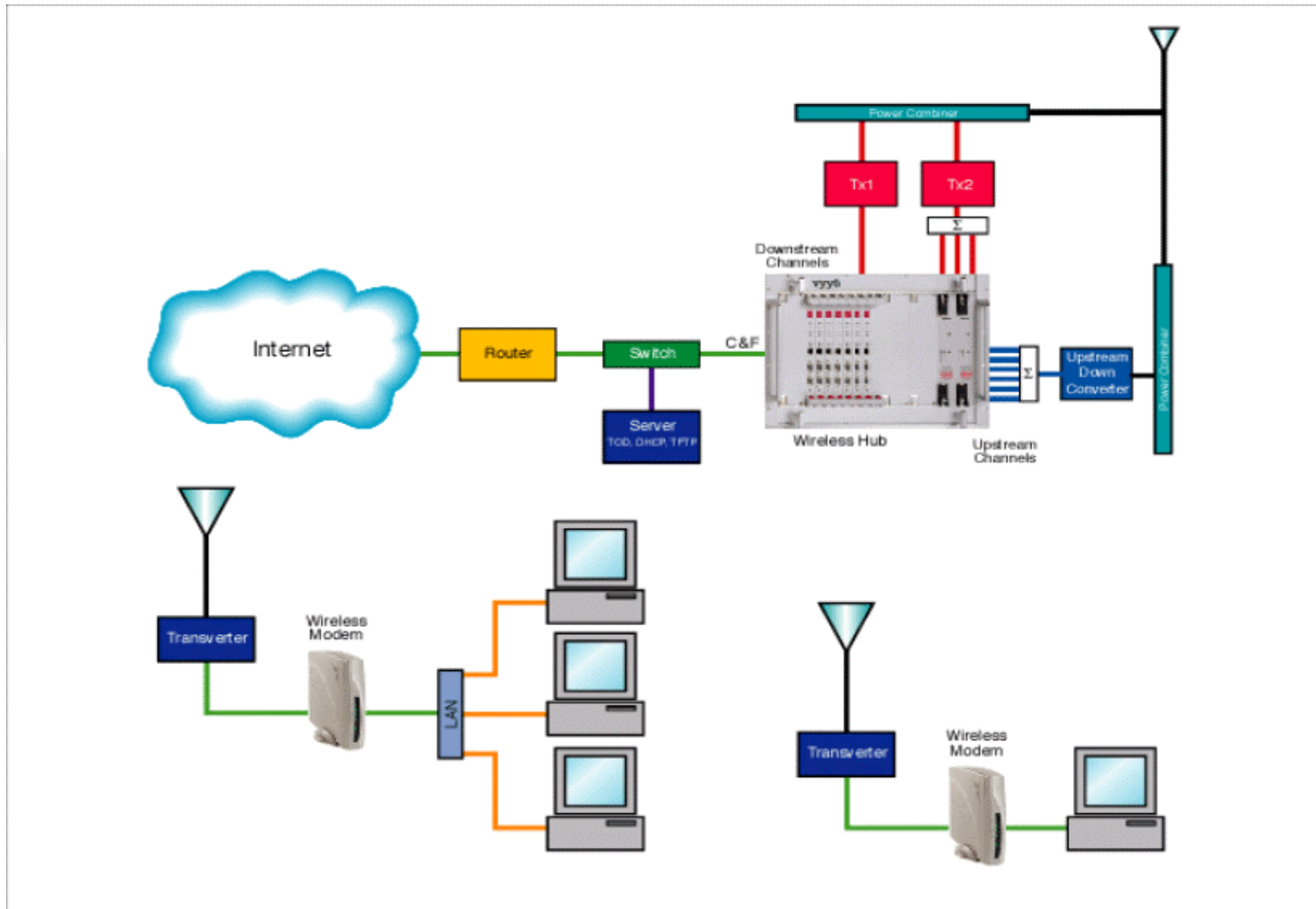

# Super Cells – Keep separated!

---

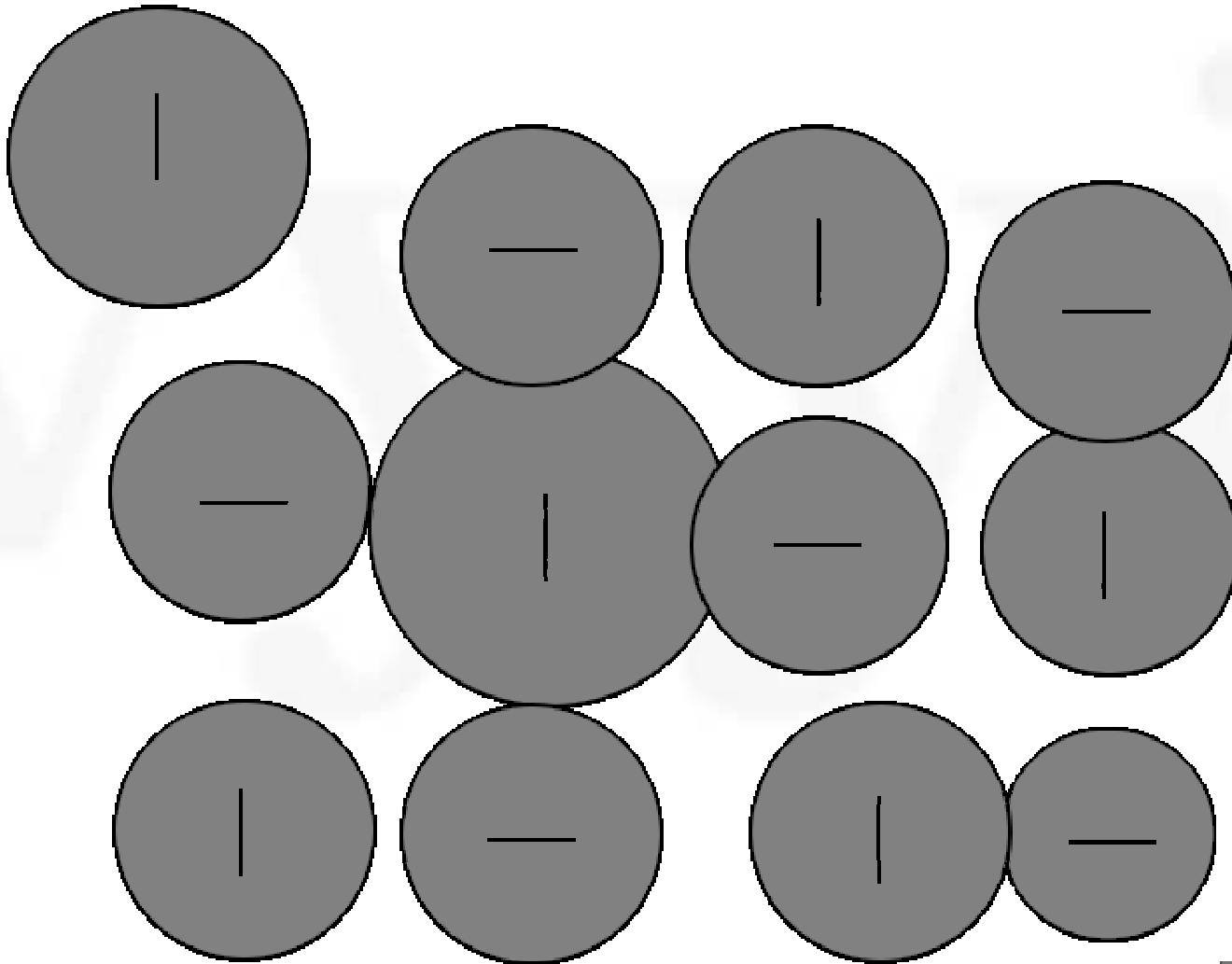

# Existing Super Cell options

---

- Add sectors
  - Convert from an omni to multiple sectors
    - Continue omni on one frequency set and use others for sectors
      - Place sectors where customers are
    - Upgrade all spectrum to several sectors
- Fill in with small cells where customers are
  - Omni cells
  - Sectorized cells

# Two sectors migrating to several

---

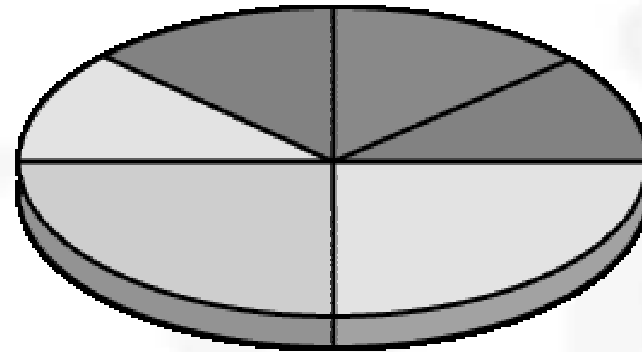
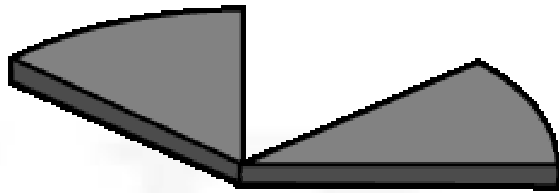

- Useful where target market is in two distinct areas

# Quad Sectors in Super Cell

---

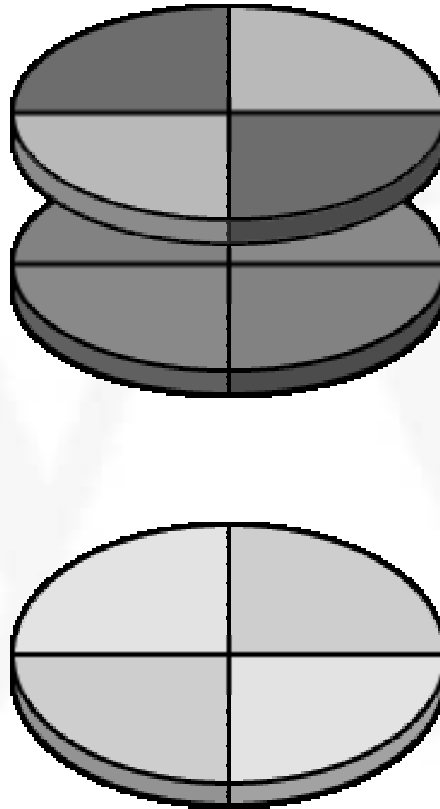

- Each Channel has a reuse of 2

# Typical Block Diagram Quad Down / Upstream Sectors

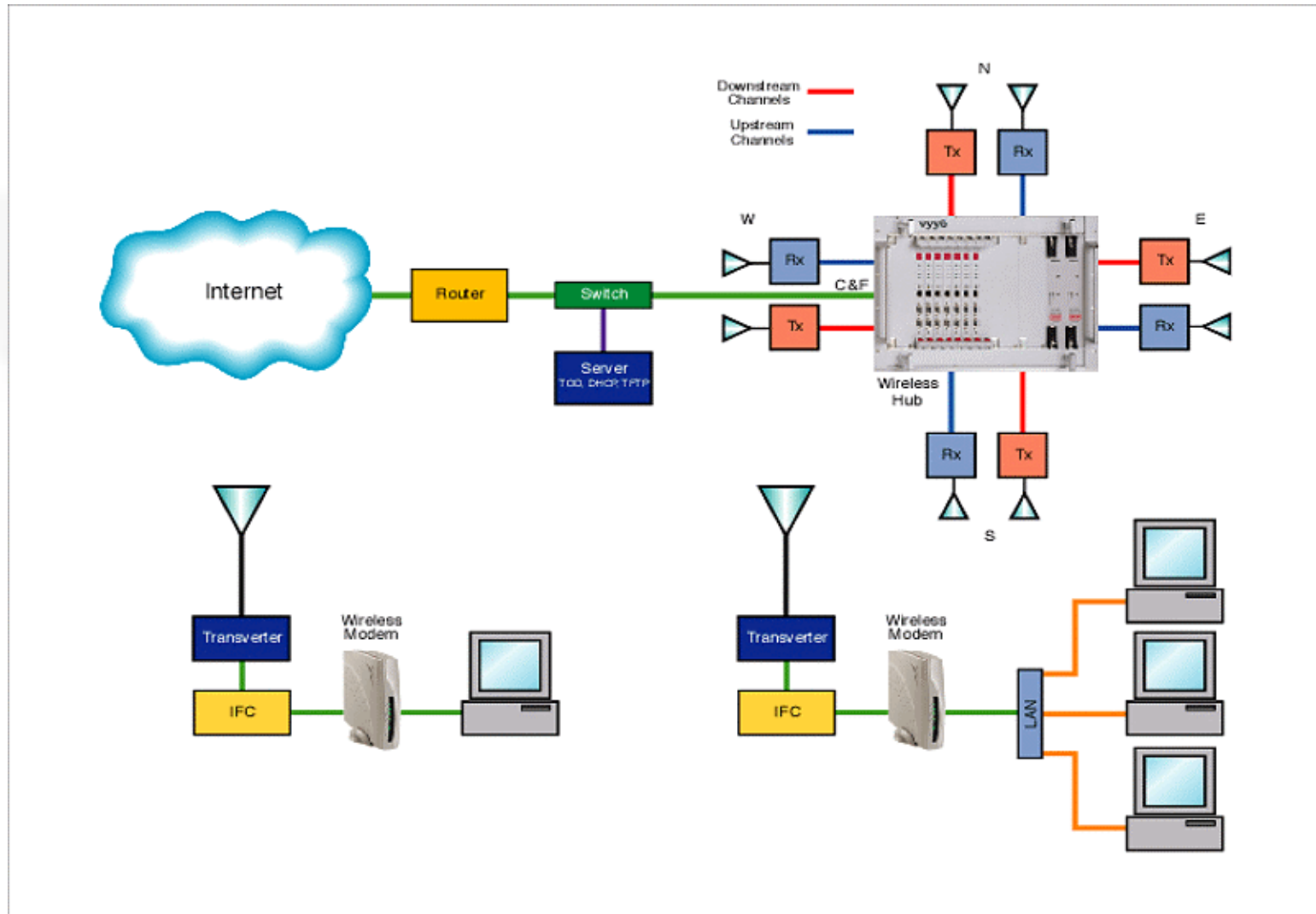

# Multiple Sectors in Super Cell

---

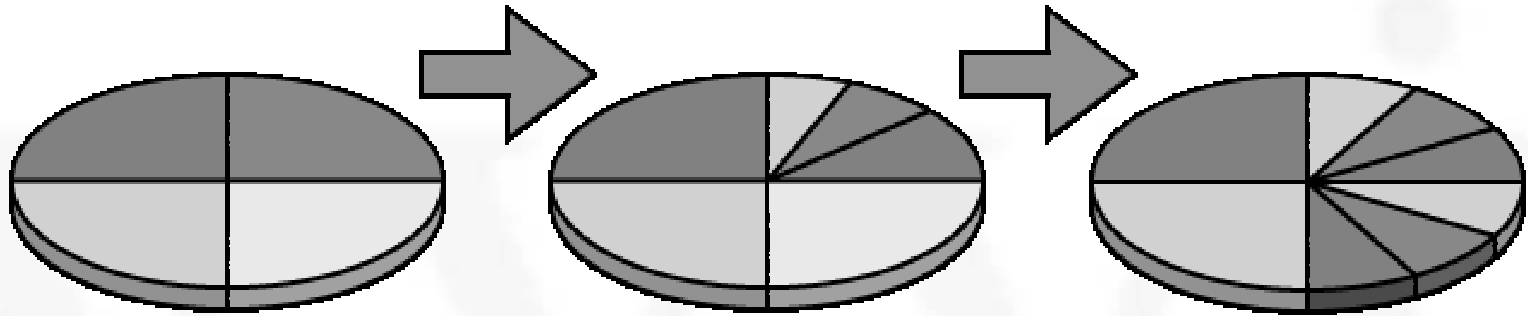

- Sectors don't need to be symmetrical as capacity is added



# Expansion of Super Cell

## Migration from Super Cell to Multiple Cells

- Locations will not be perfect
  - Ideal roof rights are impossible to get
- Some cells will need more sectors or be closer together than others

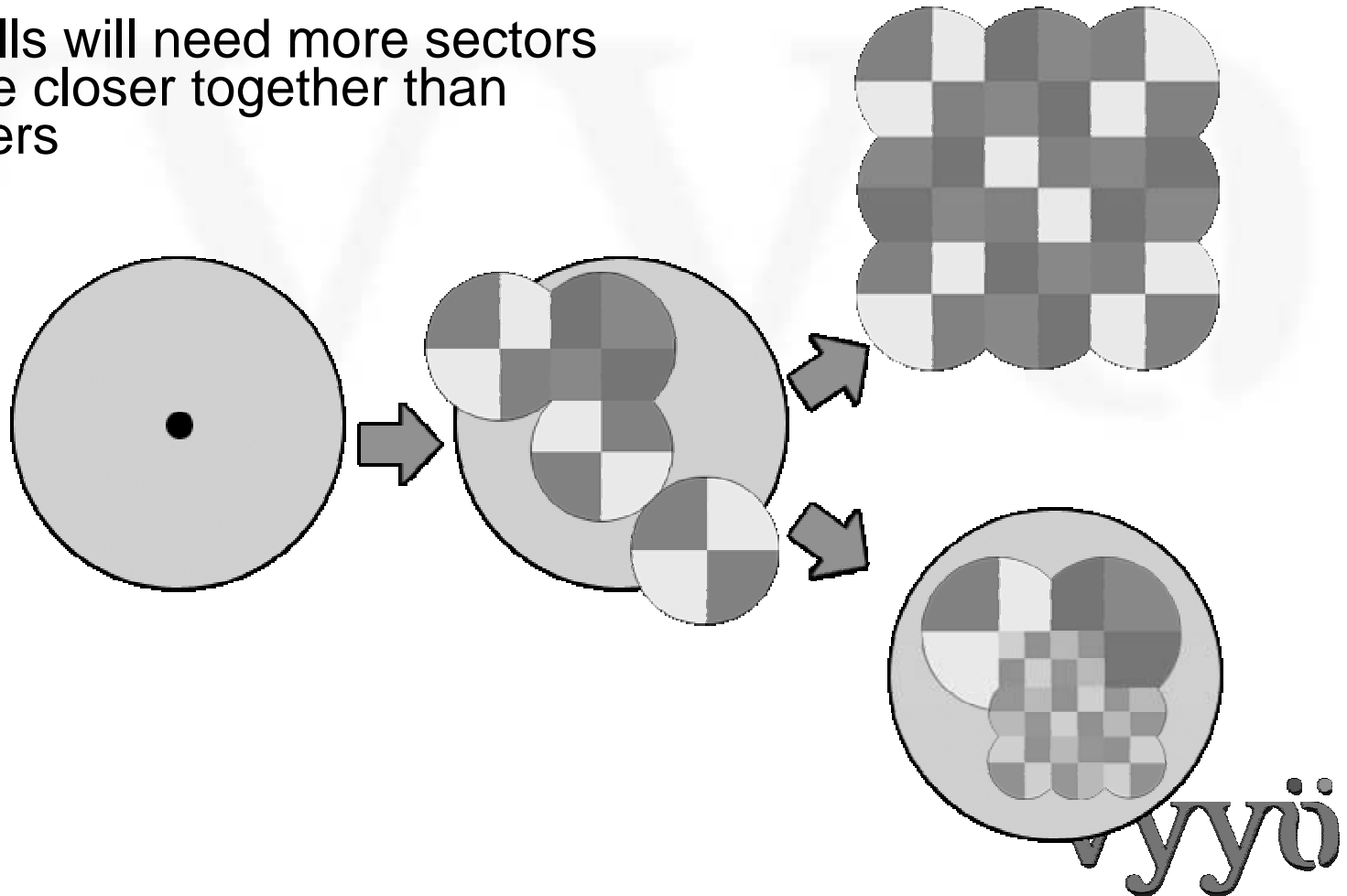

# 45 degree Antenna Pattern

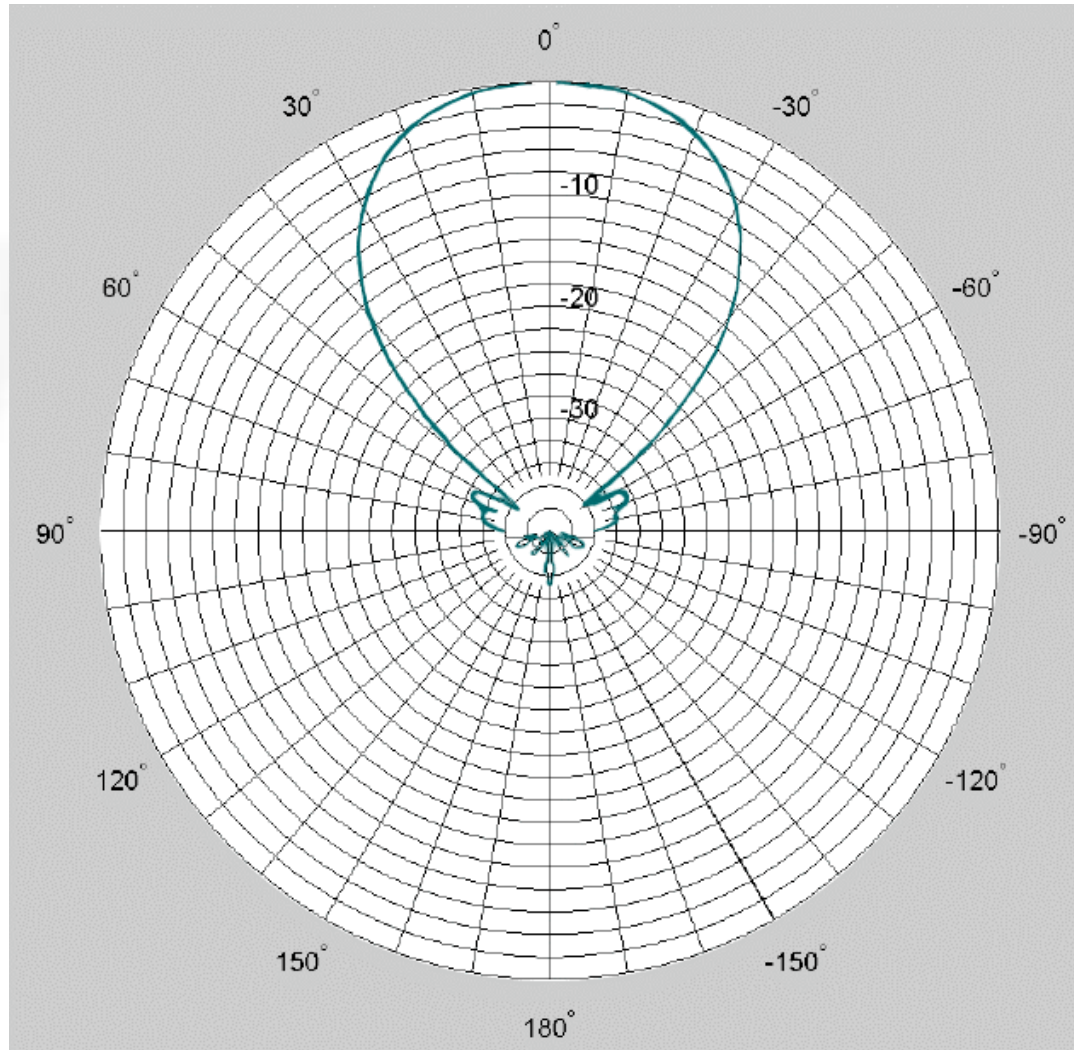

# Two ways of plotting Antenna Patterns

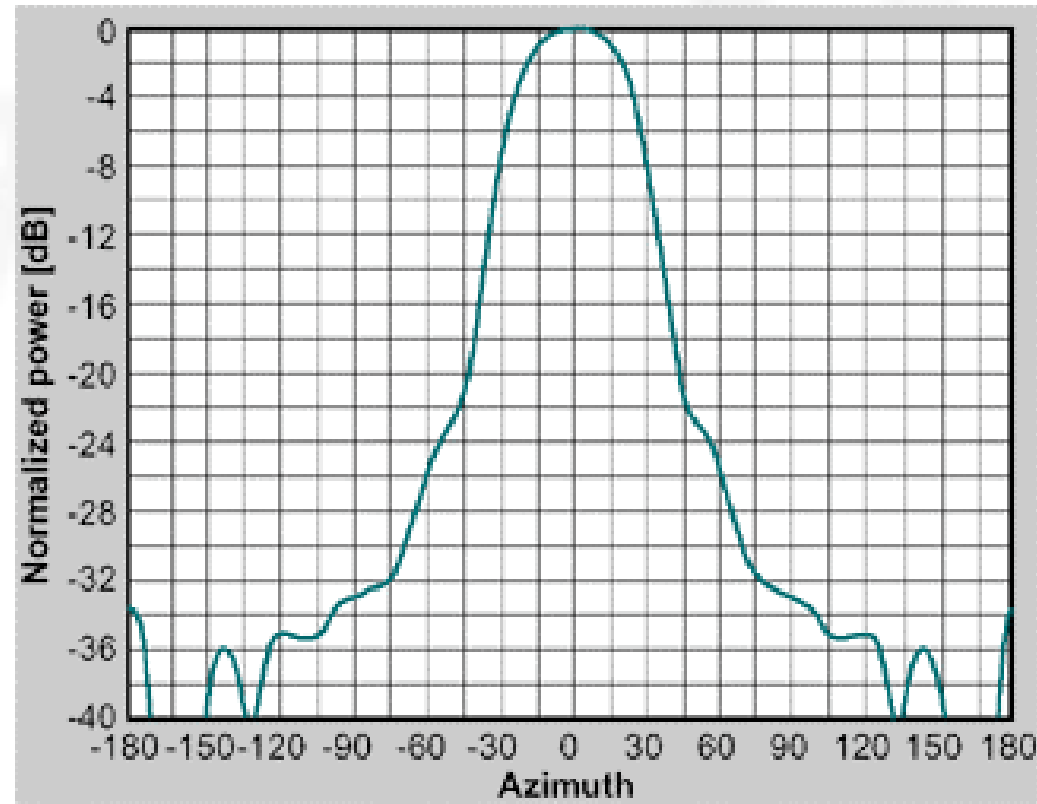
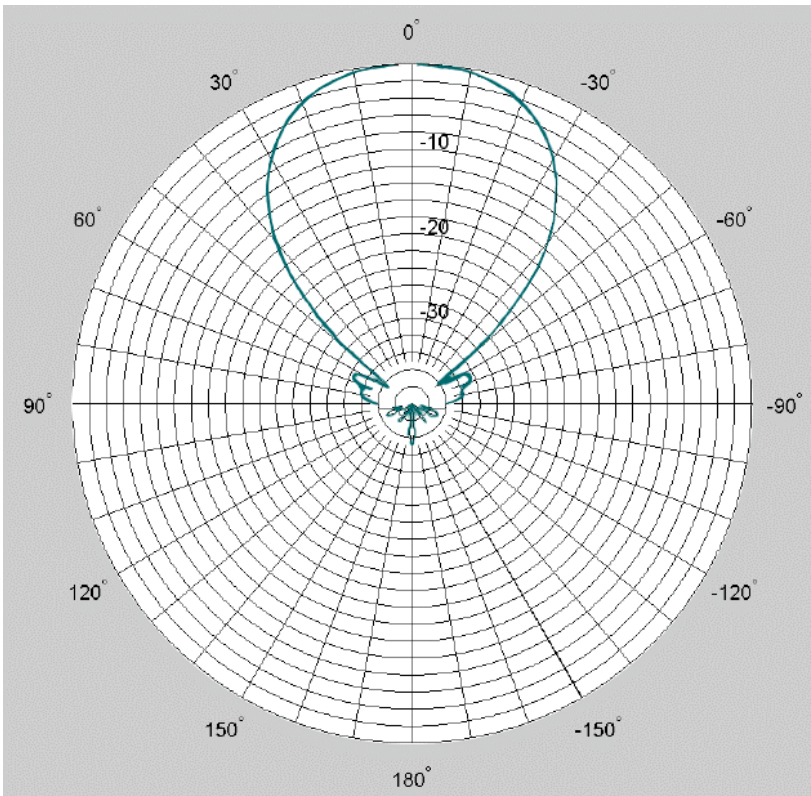

# 90° Sector Antennas Two models compared

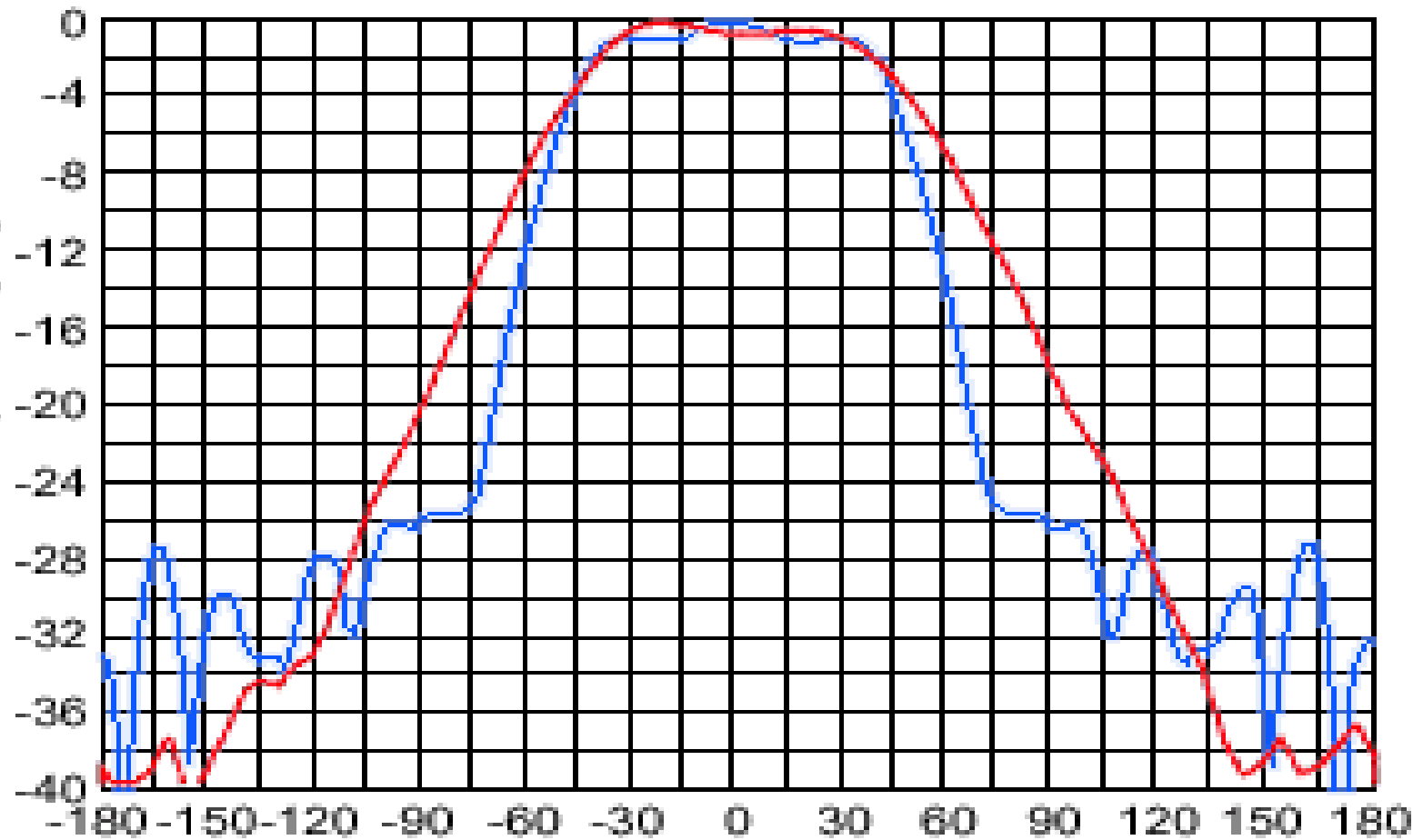

# Sector to Sector Isolation

---

- Modulation determines isolation required
  - QPSK (2 b/Hz) requires > 12 dB SNR
  - 16 QAM (4 b/Hz) requires > 18 dB SNR
  - 64 QAM (6 b/Hz) requires > 25 dB SNR

# 90° Sectors in four cell clusters

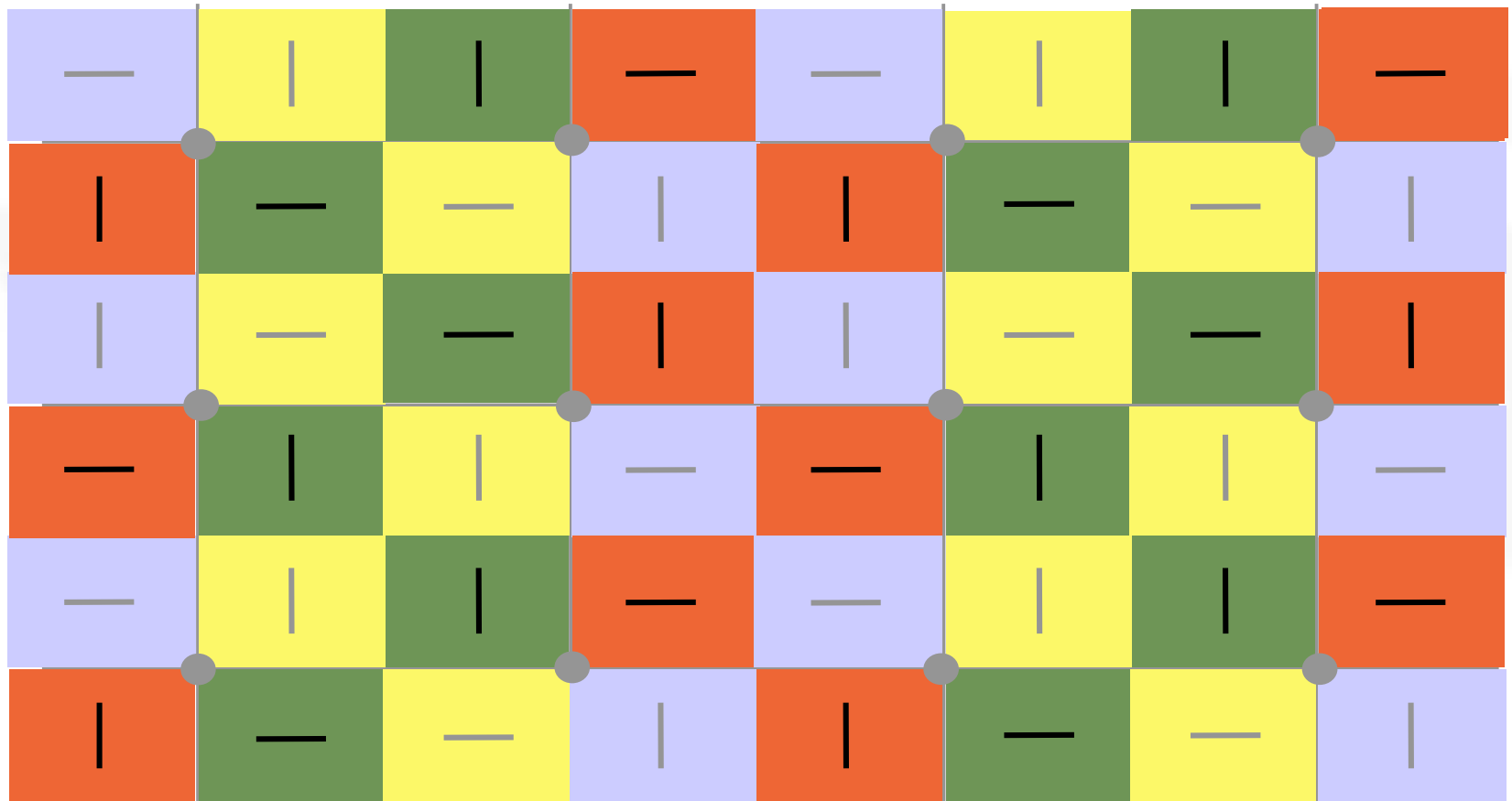

- Polarity adds isolation
  - shown with lines

# Quad Sectors -- Capacity

---

4	Number of sectors per cell
90	Size of sector (degrees)
2	Cells per cluster
4	Channels per set
1	Frequency Reuse
5	Distance to same channel (factor)
14	Distance isolation (dB)
8	Polarity isolation (dB)
22	Sum (dB)
26	Antenna isolation (dB)
22	Net isolation (dB)
16 QAM	Modulation
4	b/Hz
4	b/Hz/cell

# Four Sector Hubs

---

- Sectors can be paired
- Single Hub
  - Need two channels per channel set
    - Reuse: 1
- More than one Hub
  - Need two channels per channel set and both polarizations are used
    - Reuse: 1



# Typical System Configuration

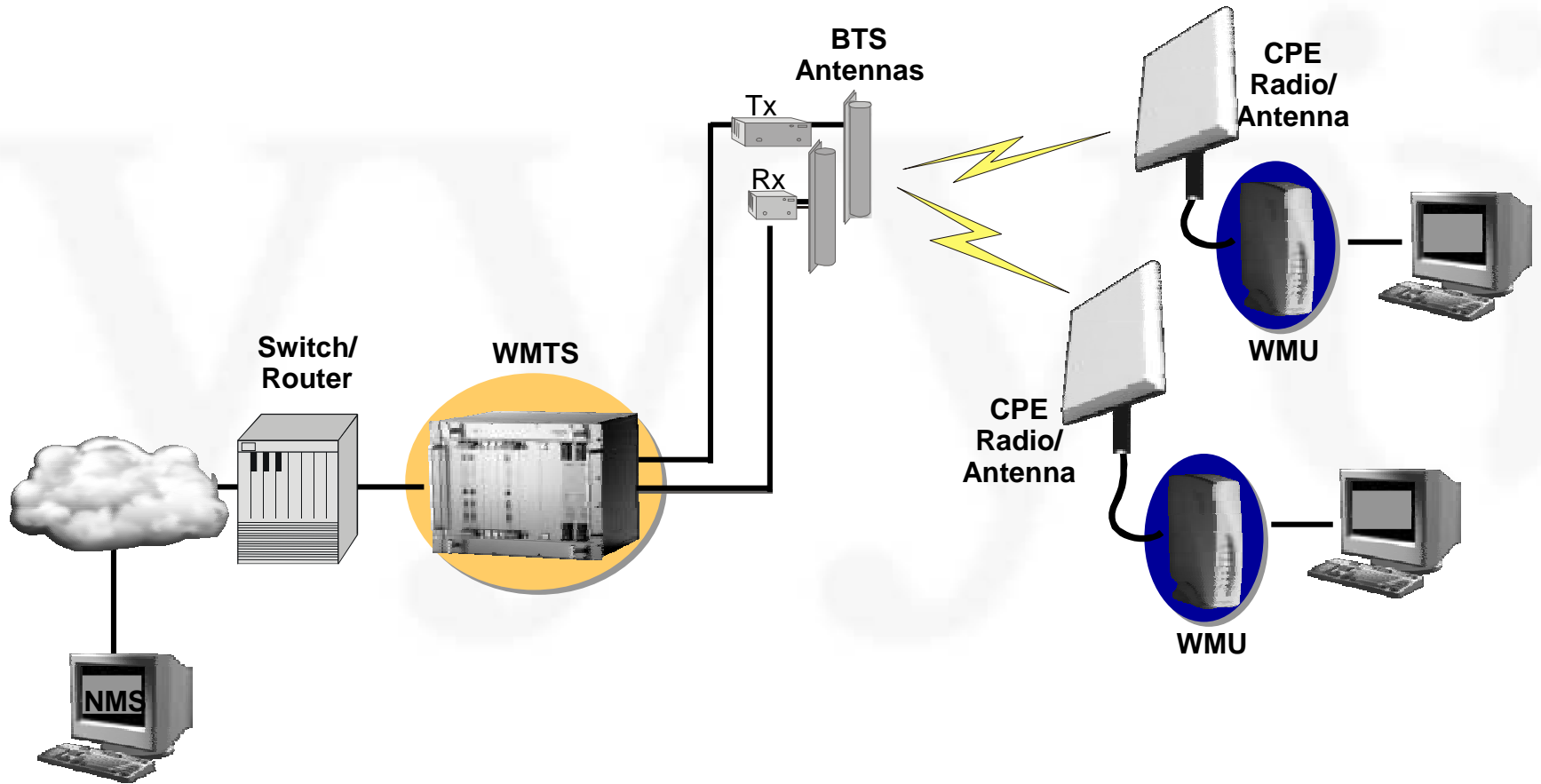

# Multiple Hubs with Three Sectors

---

- Each sector requires separate channel
  - Each antenna sector overlaps the others
  - Reuse:  $1/3$

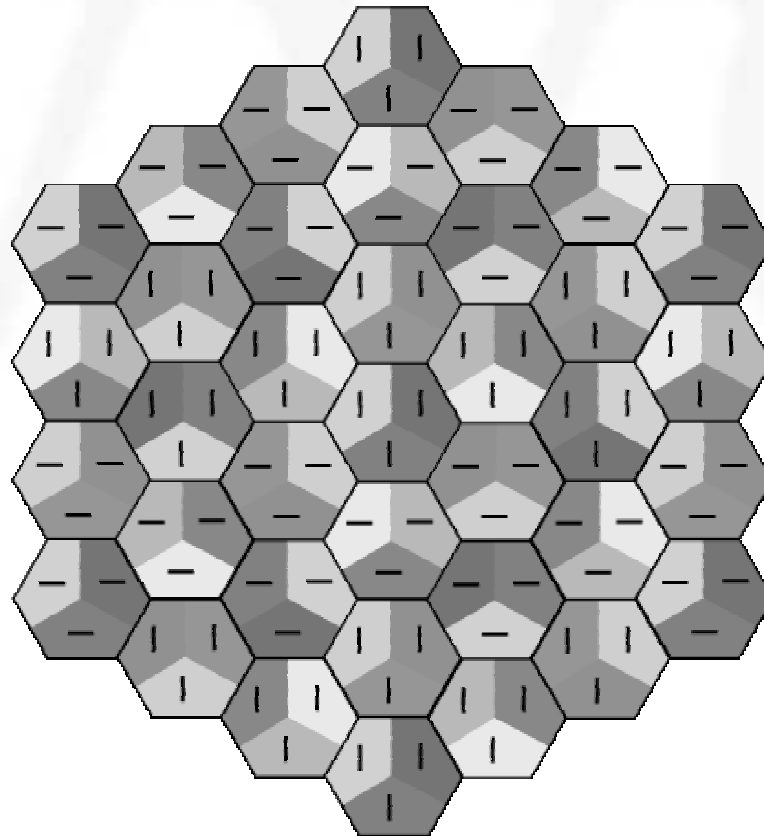

# 120° sectors – Polarization shown

---

- Cell to cell isolation is 7x distance plus polarity
  - But sector antenna isolation is only 12 dB

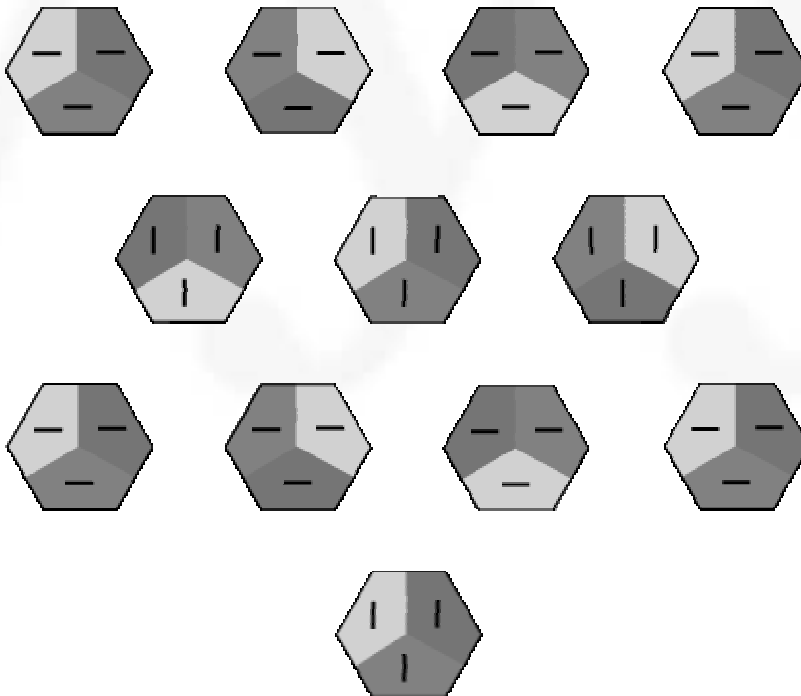
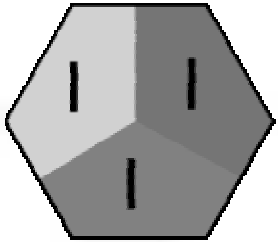

# 60° Sector Antenna

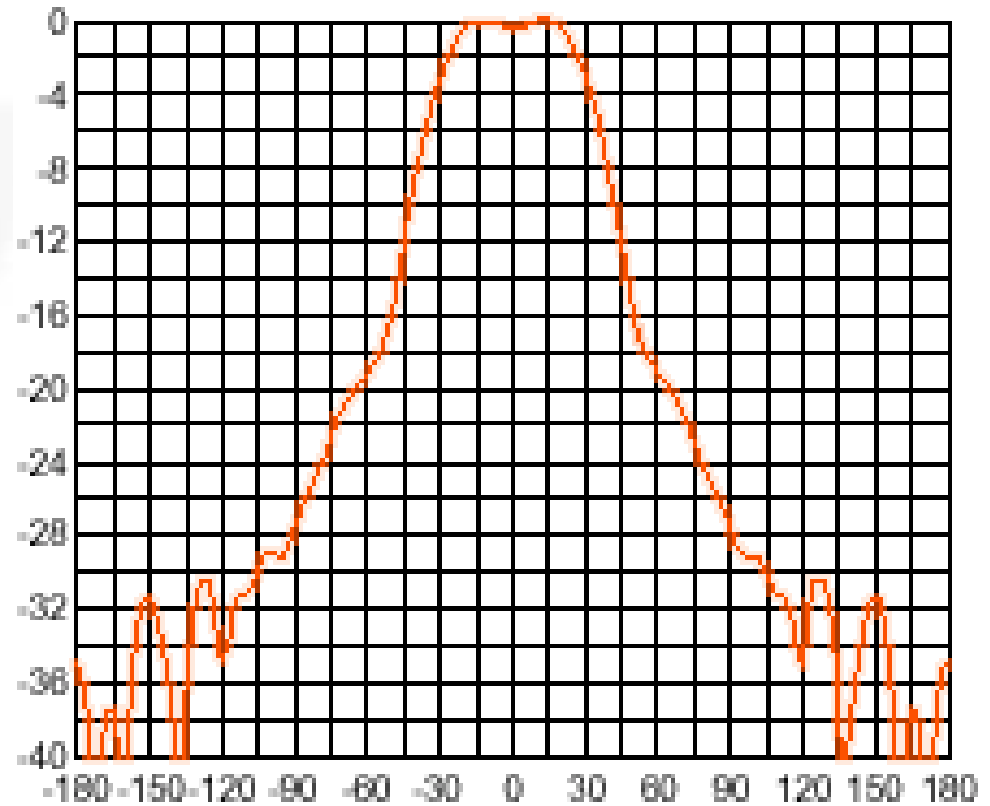
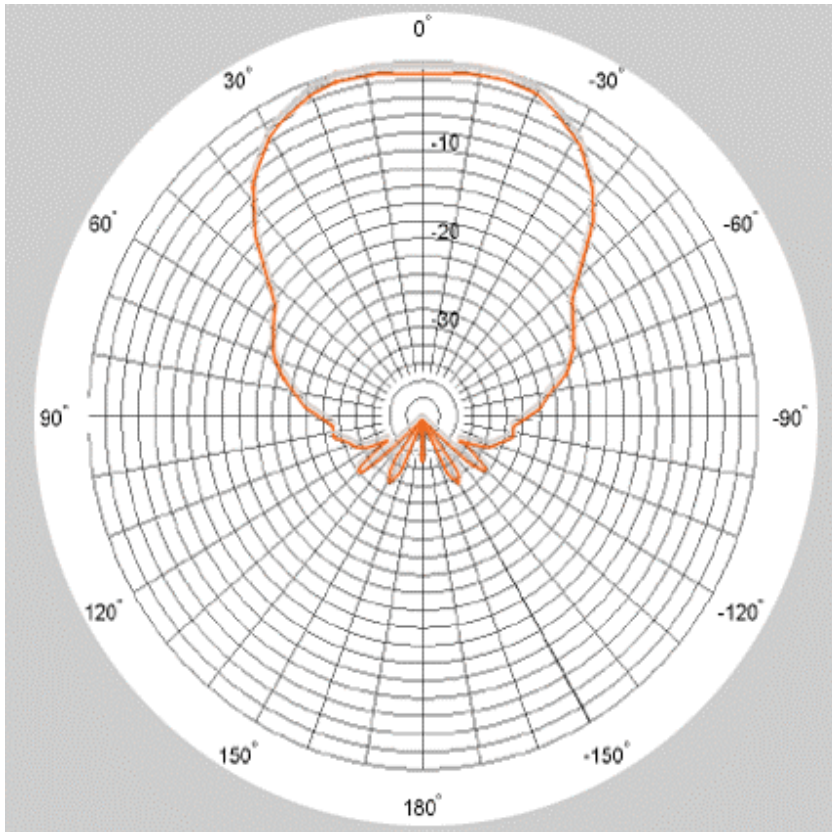

# 60° Sectors / 180° apart

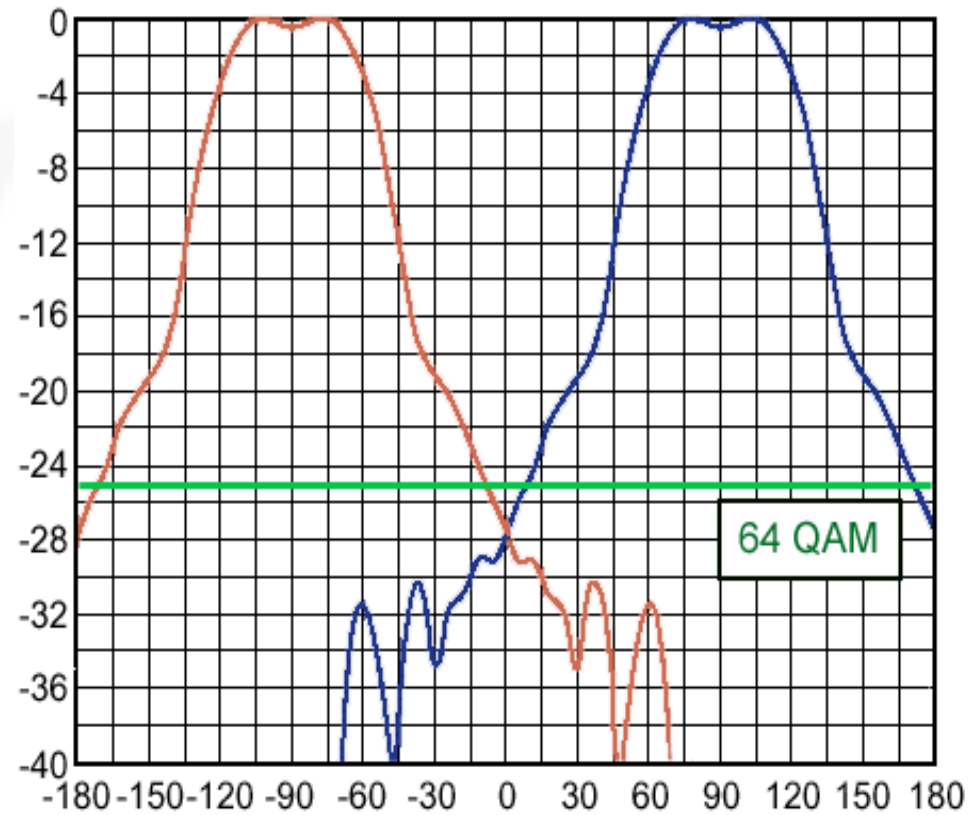
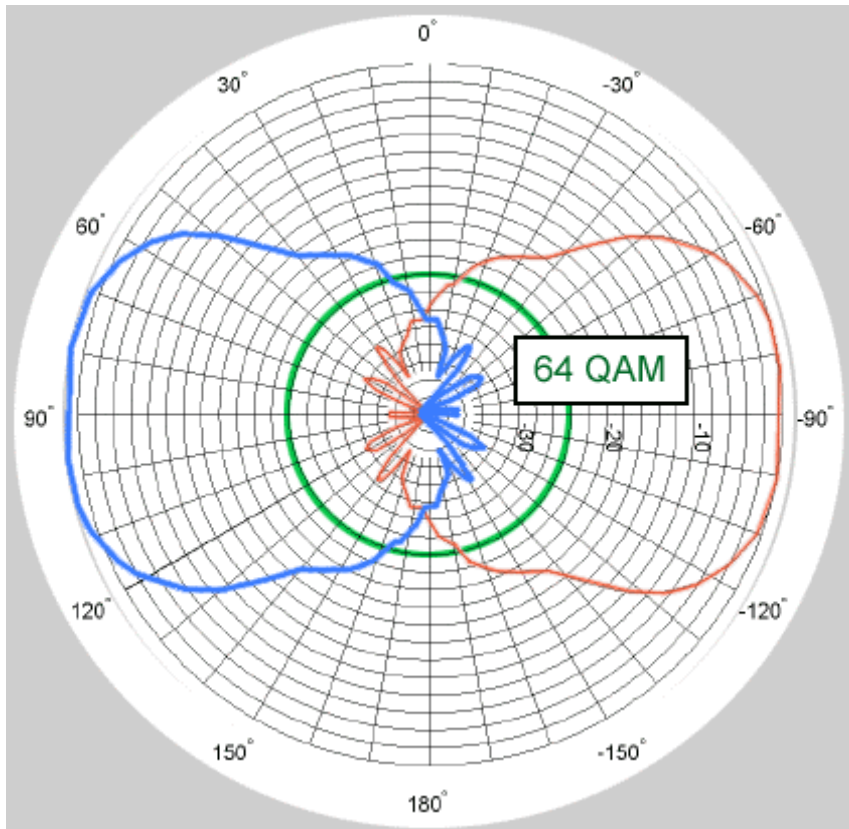

# Two 60° Sector Antenna Models

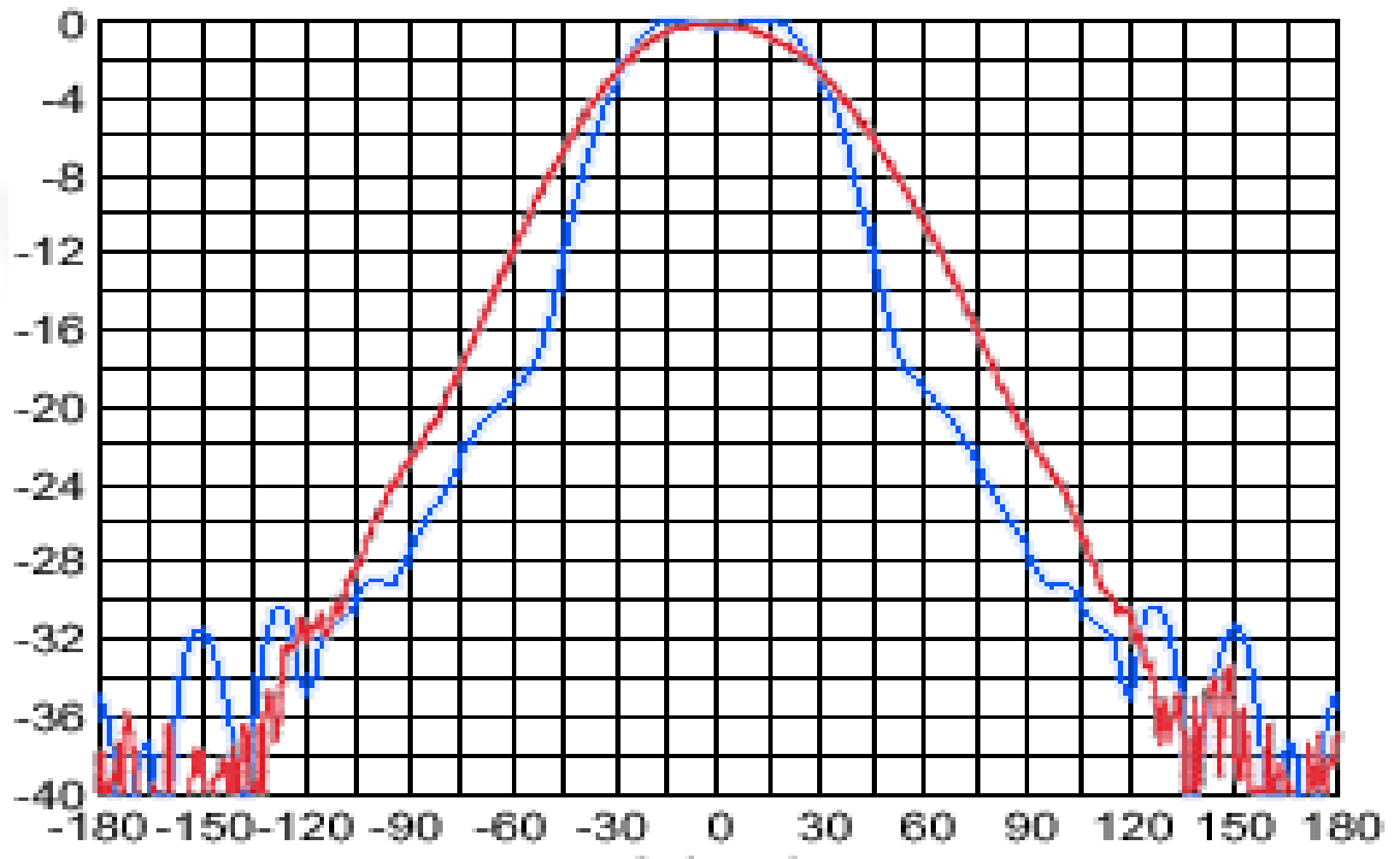

# Three 60° Sectors -- QPSK

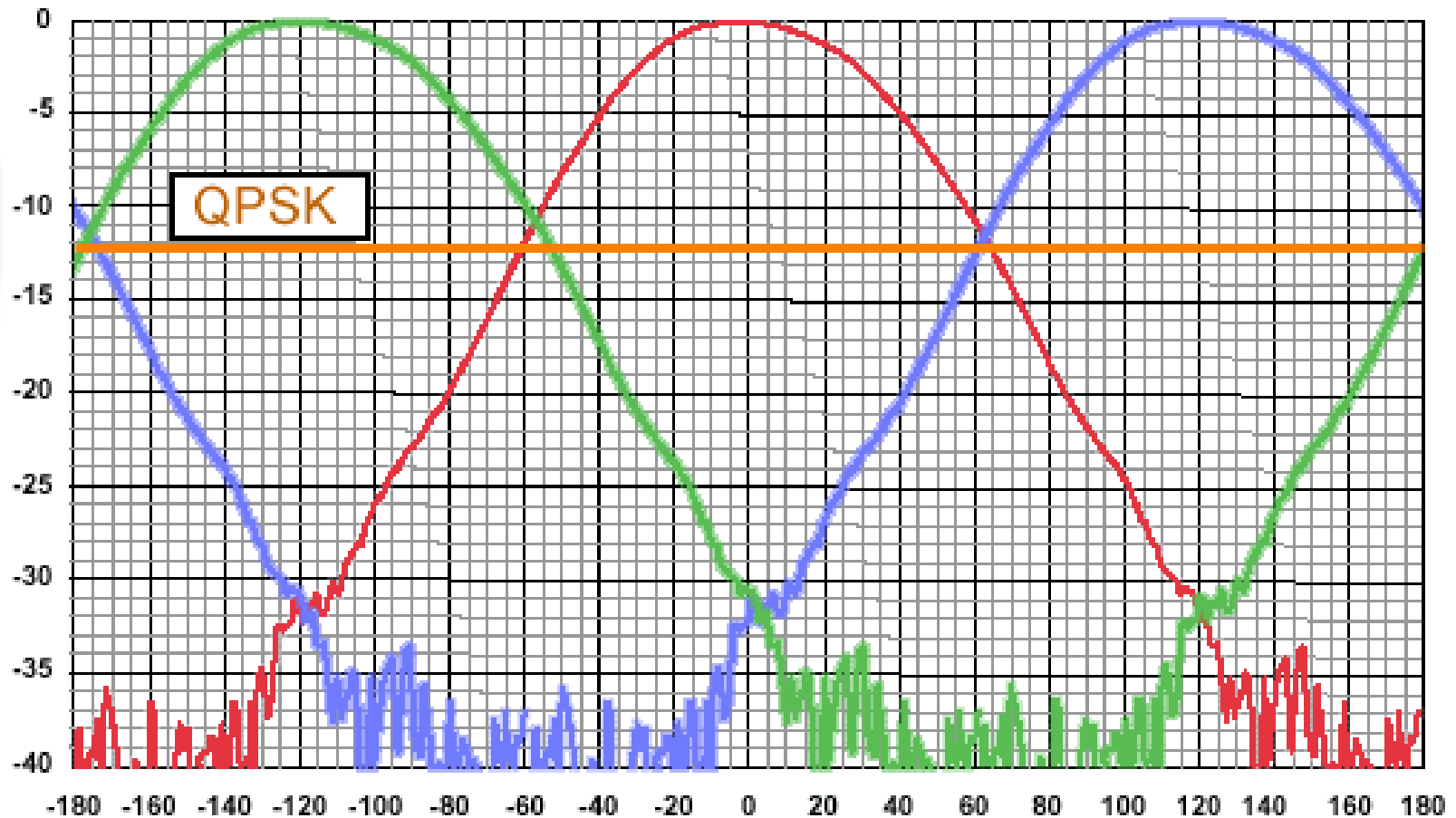

# Three 60° sectors – 16 QAM

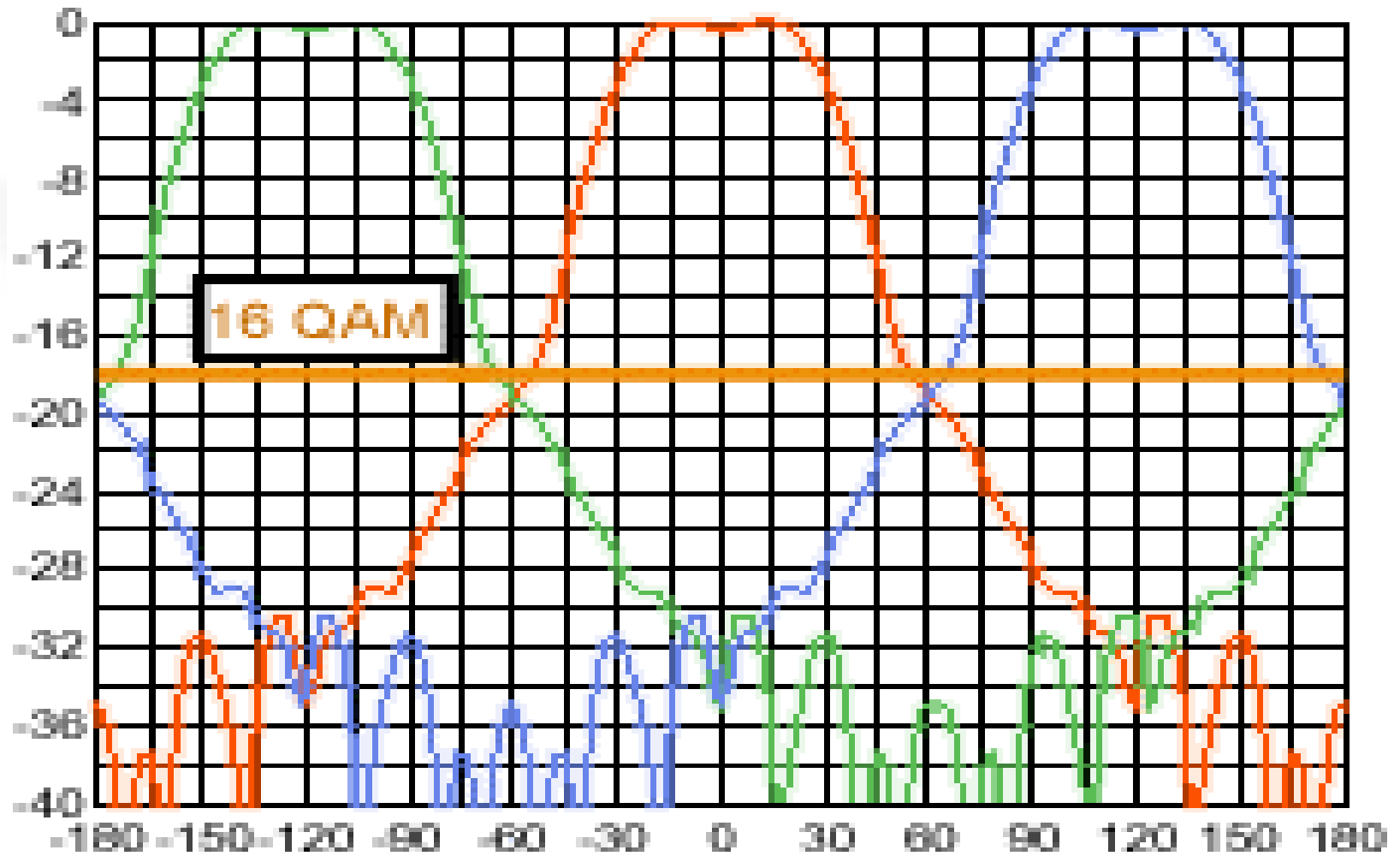



# Single Hub with Six Sectors

- Sectors can use independent channels
  - Reuse: 1
  - 4 bps / Hz
- Sectors can be paired
  - Reuse: 2
  - 8 bps / Hz

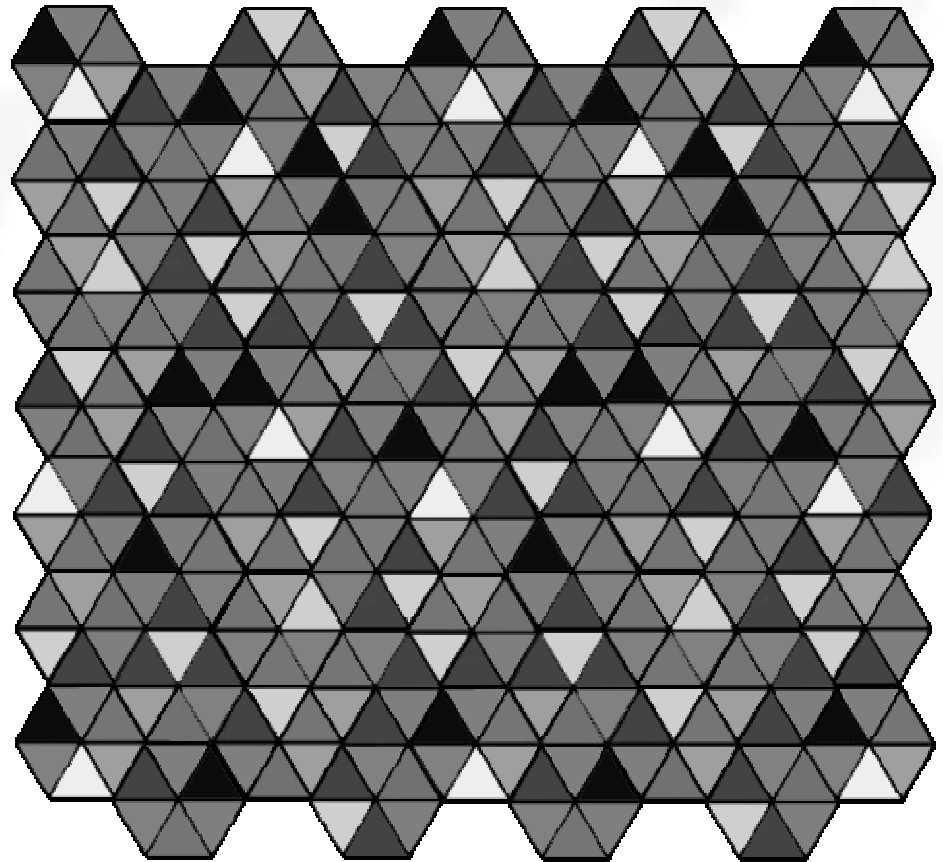

# 6 Sector Cells

- Distance isolation is 13 with 6 channel sets

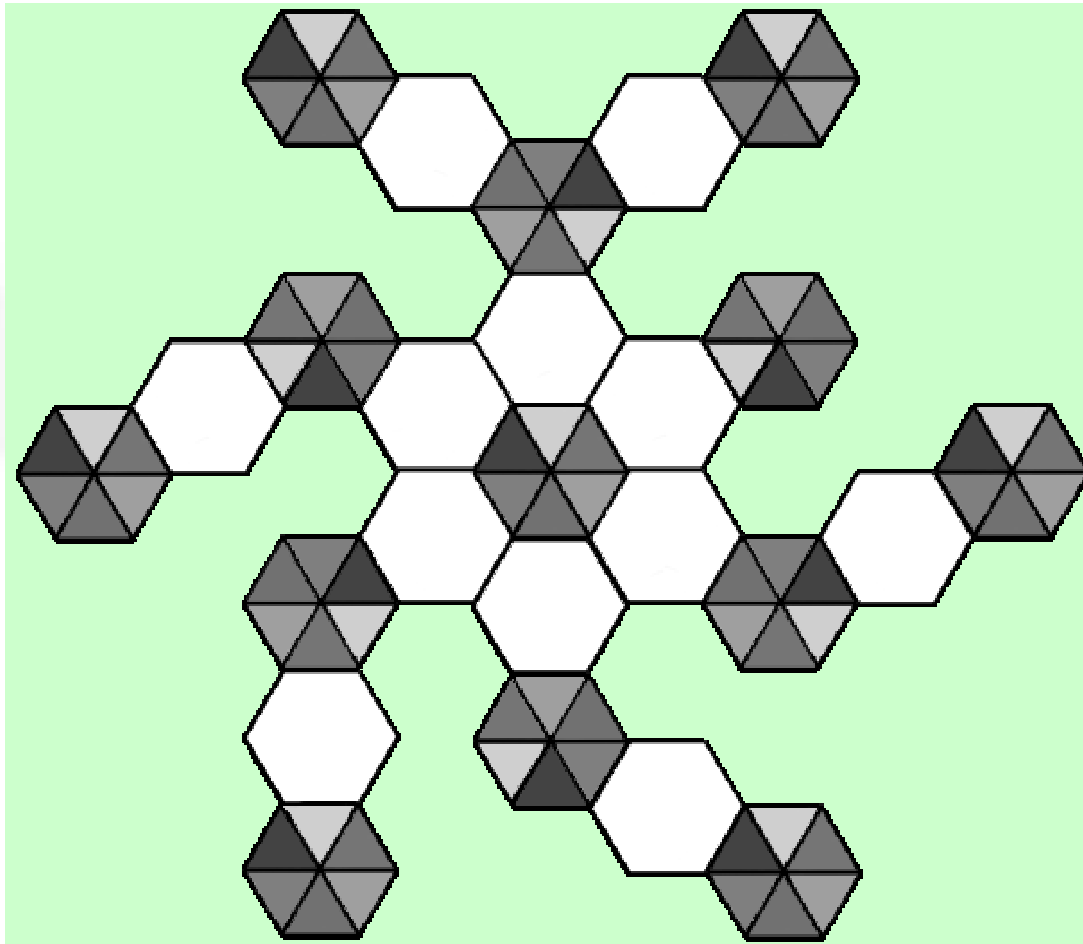

# 45 degree Antenna Pattern

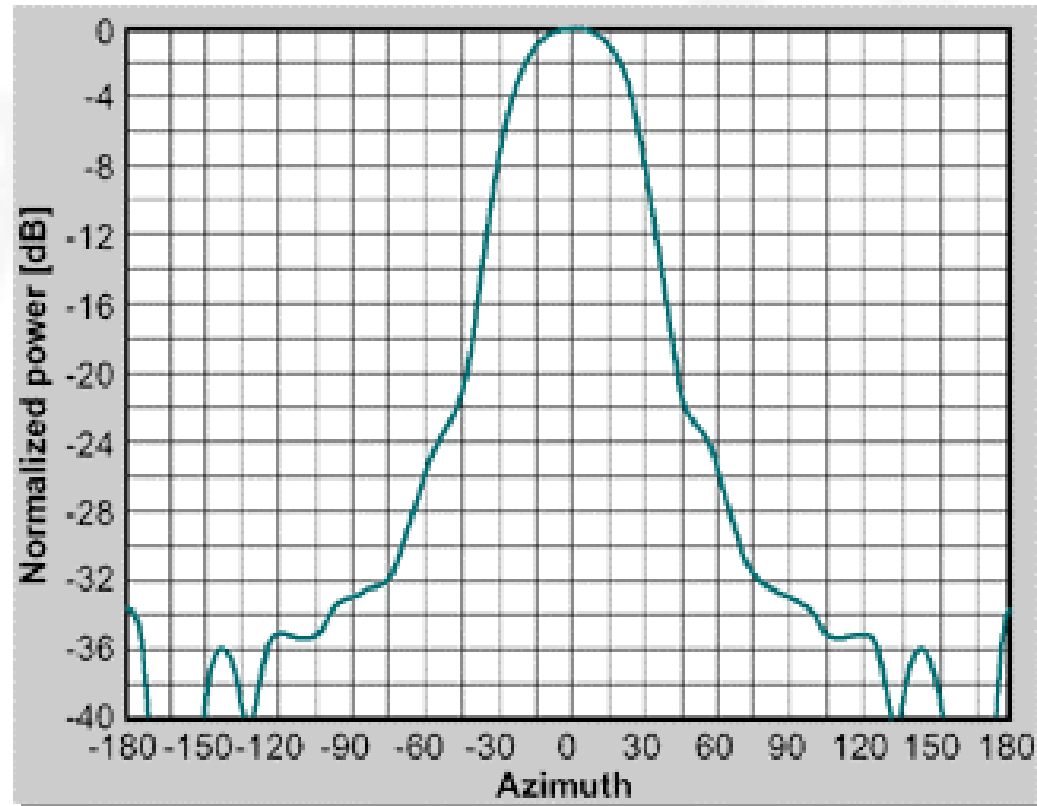
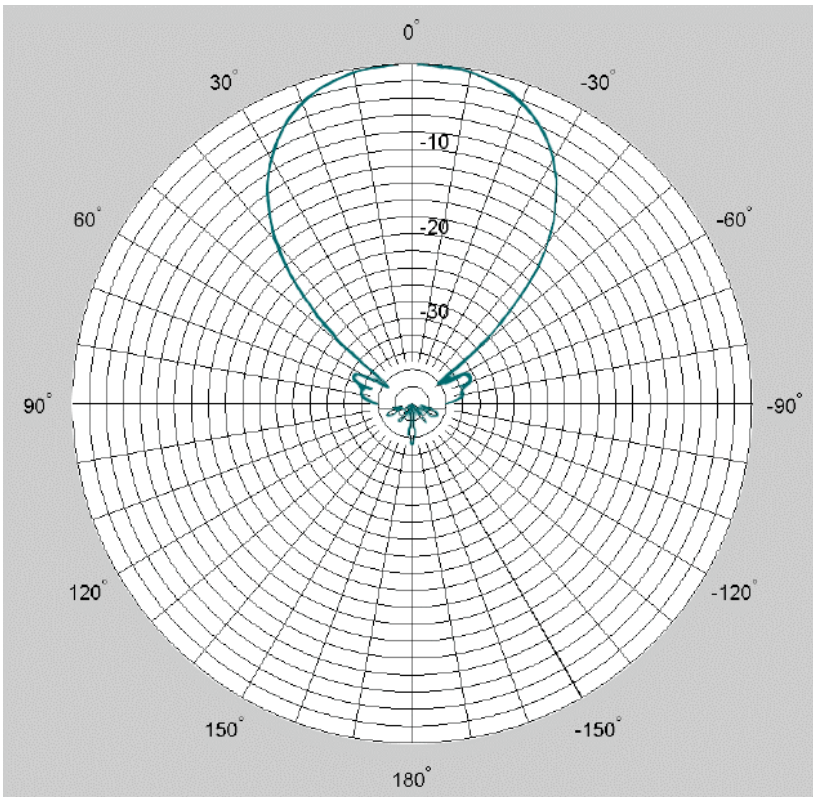

# Single Hub with Eight Sectors

---

- Sectors can be paired
  - Reuse: 2
  - 64 QAM
  - 12 bps / Hz
- Each Channel can be used on four sectors
  - Reuse: 4
  - 16 QAM
  - 16 bps / Hz

# Self Interference

---

- Highly sectorized cells may cause too much interference between sectors
  - Downstream has higher SNR requirement
    - 16 QAM
    - 64 QAM
    - Adaptive Modulation helps
- Need to balance self interference, adjacent cell interference, data throughput needs, and cost

# Narrower Upstream Sectors

---

- Fixed Phased Array Panel type of products
  - Many sectors possible
    - Twelve 30° sectors
      - Three sectors per 90° panel
    - Twenty-four 15° sectors
      - Six sectors per 90° panel

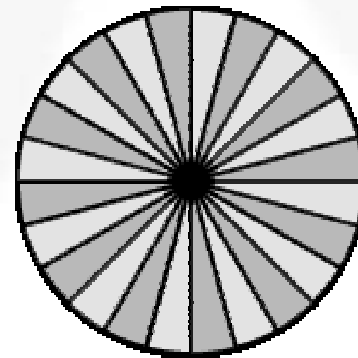
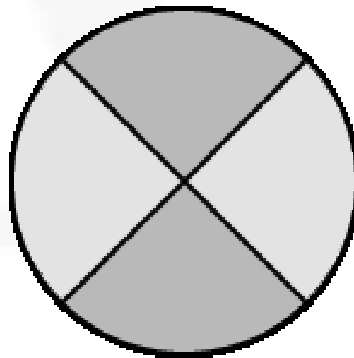
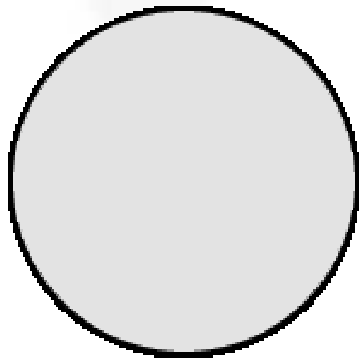

- Useful for reducing asymmetry in MDS, WCS, MMDS and 3.5 GHz systems

# Six Beam / 90° Phased Array Panel

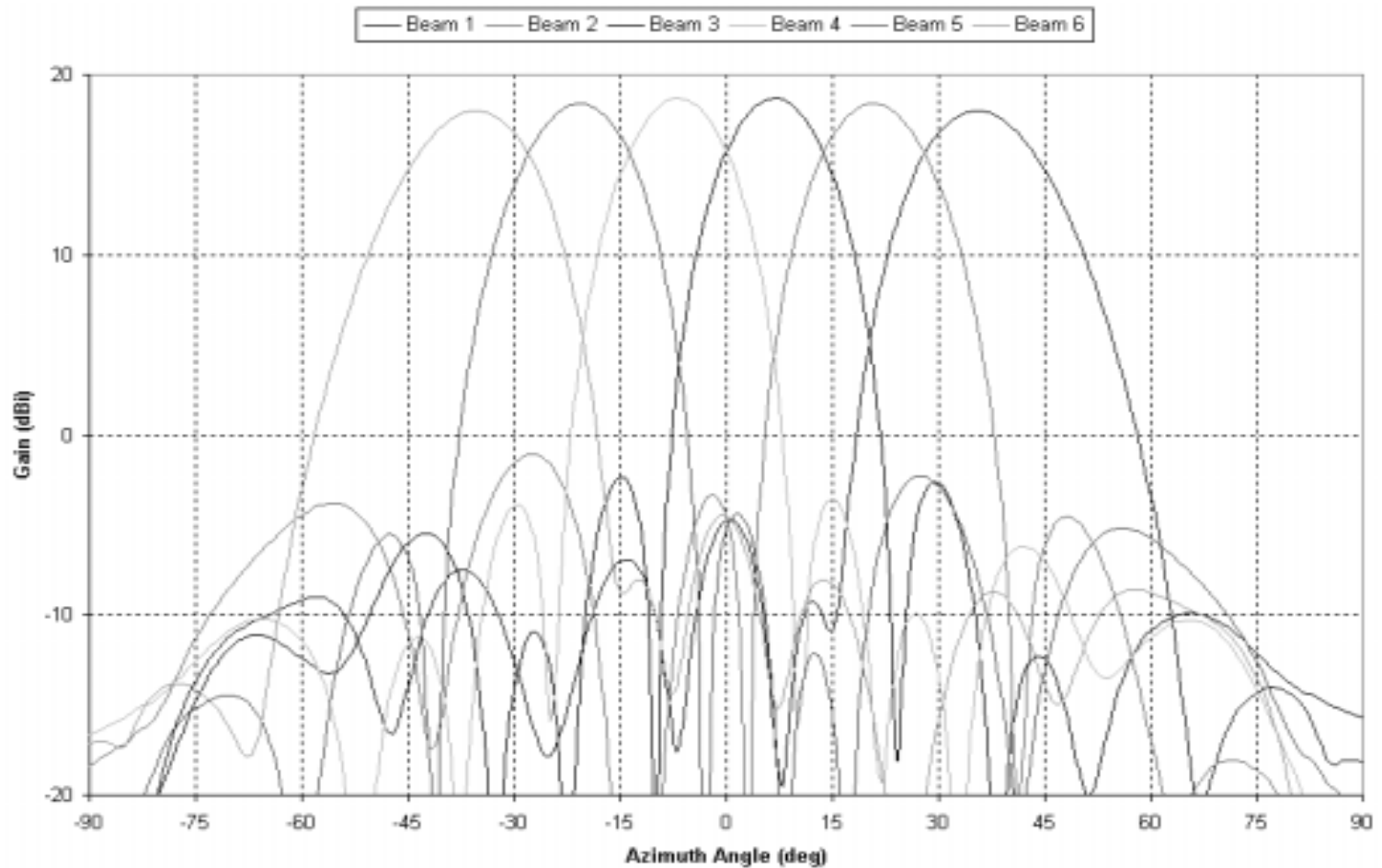

# 15° sectors 6 channels

---

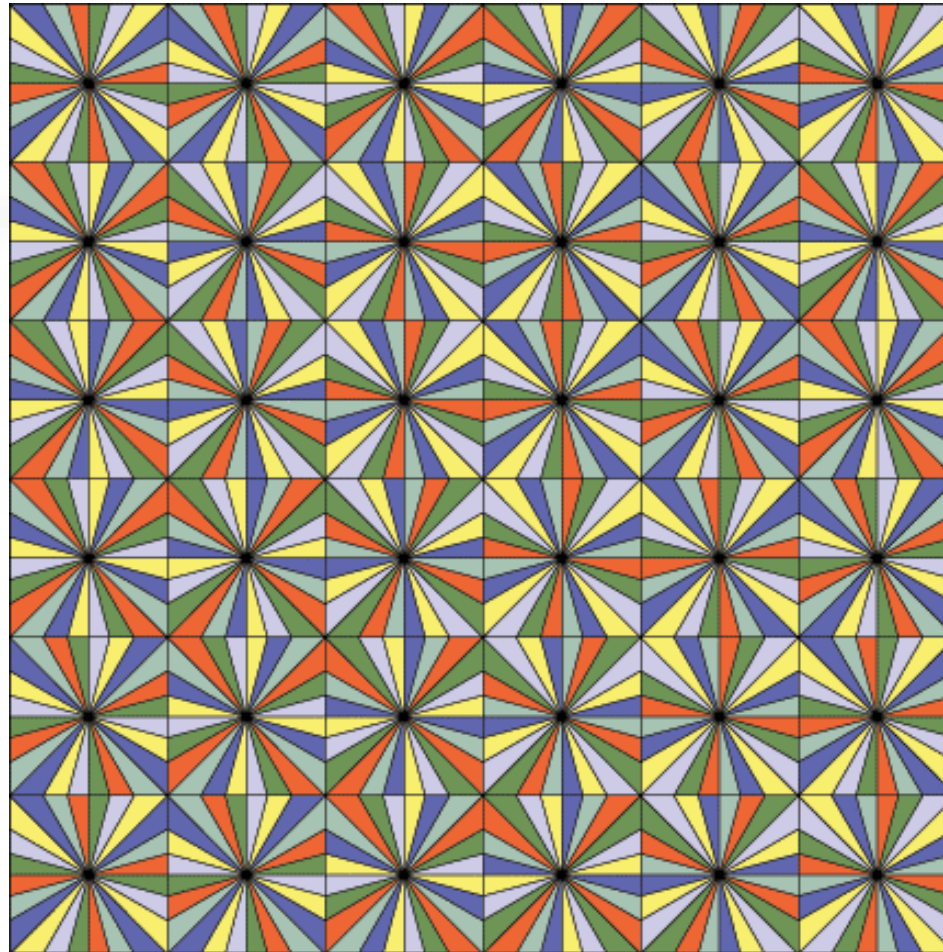



# Upstream 24 Sector Layout 3 channels

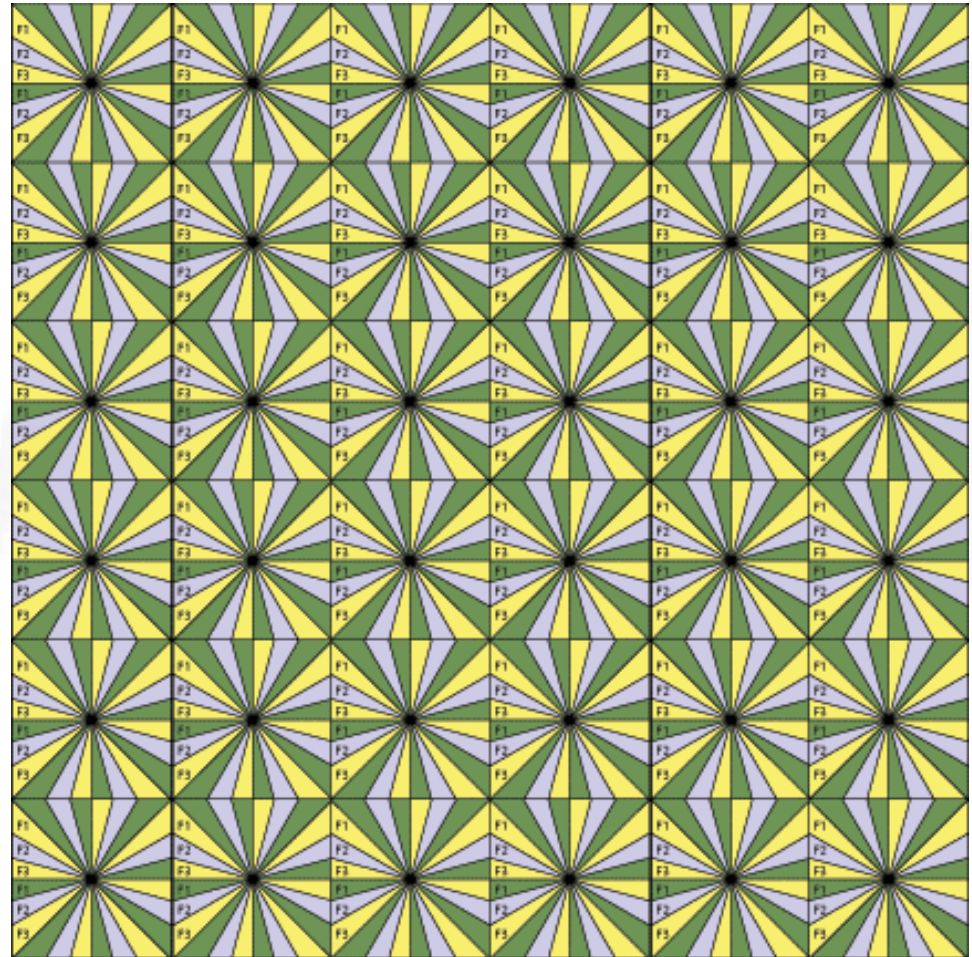
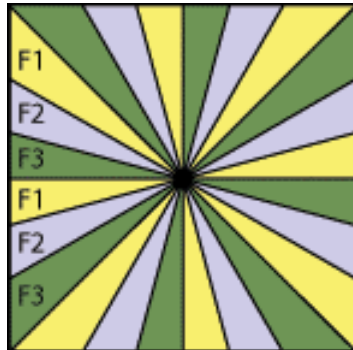

# The Key isn't Just Frequency Reuse

---

- Why go to the trouble of multiple sectors?
  - It isn't Frequency reuse
  - It isn't spectrum efficiency
  - It is a combination
- More traffic per square km
  - Each sector increases the throughput
    - Up to a limit

# How Many Upstream Sectors?

---

- Sector to sector isolation is not an issue for 4 to 8 sectors
  - Four sectors  $(2 \text{ bps/Hz}) * (4 \text{ sectors}) / 4 \text{ channels}$   
2 bps/Hz effective for the cell
  - Six sectors = 4 bps/Hz
  - Eight sectors = 8 bps/Hz
- With Twenty-four  $15^\circ$  sectors, antenna isolation is 16 dB
  - $(2 \text{ bps/Hz}) * (24 \text{ sectors}) / 4 \text{ channels}$   
12 bps/Hz effective throughput

# Asymmetry in MDS / MMDS (WCS also)

---

- Upstream
  - Only 12 MHz of bandwidth
    - Fifteen 800 KHz channels
    - QPSK == 18 M bps gross
- Downstream
  - Up to 186 MHz of bandwidth
    - Thirty-one 6 MHz channels
  - Without sectorization
    - QPSK == 310 M bps
    - 16 QAM == 620 M bps
    - 64 QAM == 930 M bps

# MDS / MMDS Upstream

---

- Tri-Sector/4 cell clusters require nine frequencies and have a frequency reuse of  $1/4$ 
  - Net data rate is 6 M bps gross per cell
- Tri-Sector/3 cell clusters require nine frequencies and have a frequency reuse of  $1/3$ 
  - Net data bandwidth is 8 Mbps gross per cell
- Quad-sector/4 cell clusters require four channels and have a frequency reuse of 1
  - Net data rate is 24 M bps gross per cell

# MDS / MMDS Upstream 24 Sectors

---

- 24 sector / 36 cell cluster
  - Reuse is 4
  - Capacity per cell is 96 Mbps gross per cell

# Asymmetry in In-Band MMDS

---

- 42 MHz upstream
  - QPSK == 65 M bps gross
    - Twenty-six 1600 KHz channels
  - If you add MDS channels == 85 M bps
    - 56 MHz = Sixteen 3200 KHz channels
- 102 MHz downstream
  - Seventeen 6 MHz channels
    - 64 QAM == 510 M bps
    - 16 QAM == 340 M bps
    - QPSK == 170 M bps

# In-Band MMDS Upstream

---

- Quad-sector/4 cell clusters require four channels and have a frequency reuse of 1
- 24 channels used per cell (6 per sector)
  - Net data rate is 60 M bps gross per cell
- 24 sector cells
  - Reuse is 4
  - Capacity is 360 Mbps gross per cell



# Asymmetry in 3.5 GHz bands

---

- 25 MHz downstream
  - 64 QAM == 80 M bps gross
  - 16 QAM == 60 M bps
  - QPSK == 40 M bps
- 25 MHz upstream
  - QPSK == 38 M bps

## 3.5 GHz Downstream

---

- 25 MHz downstream bandwidth means four 6 MHz channels
- Quad-sector/4 cell clusters require four channels, have a frequency reuse of 1, and isolation is acceptable for 16 QAM
  - Data rate is 96 M bps gross per cell

# 3.5 GHz Upstream

---

- 25 MHz upstream bandwidth means fifteen 1.6 MHz channels
- Quad-sector/4 cell clusters require four channels and have a frequency reuse of 1
  - Net data rate is 48 M bps gross per cell
- Twelve sector cell has a frequency reuse of 3
  - Cell data rate is 90 M bps gross

# Asymmetry in LMDS

---

- QPSK in both directions
- Band may be split as required by traffic expectations; asymmetry is typically not an issue
- Quad-sector/4 cell clusters require four channel sets and have a frequency reuse of 1
  - Downstream
    - 8 channels (48 MHz) grosses 80 M bps
  - Upstream
    - 16 channels (52 MHz) grosses 80 M bps

# Downstream Examples

Number of Sectors per cell	Size of sector (degrees)	Cells per cluster	Channels per set	Frequency Reuse	Distance to same Channel (factor)	Distance Isolation (dB)	Polarity Isolation (dB)	sum (dB)	Antenna Isolation (dB)	Net Isolation (dB)	Modulation	b/Hz	b/Hz/cell
1	360	1	1	1	3	10	8	18	0	18	16 QAM*	4	4
3	120	3	9	0.333	7	25	8	33	13	13	QPSK	2	0.67
4	90	2	4	1	5	14	8	22	26	22	16 QAM	4	4
6	60	1	6	1	7	17	8	25	25	22	16 QAM	4	4
6	60	1	3	2	13	22	0	22	22	21	16 QAM	4	8
8	45	1	4	2	5	14	8	22	27	22	64 QAM	6	12
8	45	1	2	4	7	25	0	25	21	21	16 QAM	4	16
12	30	1	4	3	7	17	8	25	15	15	QPSK	2	6
12	30	1	3	4	5	14	0	14	15	12	QPSK	2	8
24	15	1	4	6	15	24	0	24	24	16	QPSK	2	12

\*Terrain, Curvature, and antenna tilt help -- real systems use 64 QAM and get 6 M bps/Hz

# Upstream Examples

Number of Sectors per cell	Size of sector (degrees)	Cells per cluster	Channels per set	Frequency Reuse	Modulation	b/Hz	b/Hz/cell
1	360	1	1	1	QPSK	2	2
3	120	3	9	0.33	QPSK	2	0.67
4	90	2	4	1	QPSK	2	2
6	60	1	6	1	QPSK	2	2
6	60	1	3	2	QPSK	2	4
8	45	1	4	2	QPSK	2	4
8	45	1	2	4	QPSK	2	8
12	30	1	4	3	QPSK	2	6
12	30	1	3	4	QPSK	2	8
24	15	1	4	6	QPSK	2	12

# Observations

(to the first order)

---

- Cell planning and sectorization are similar at any Line of Sight frequency
- Different Antennas designs have very different patterns
  - Each is optimized for something
- Spatial (Vector) Diversity normalizes out
- OFDM and other advanced modulations are actually variations of QAM modulation and follow the same principles
- FEC, ARQ, DCS, etc don't change the fundamentals
- Adaptive Modulation helps downstream throughput

# Realities

---

- Techniques are applicable to all of the different bands
- Constraints are very different
  - MMDS
    - MDS is 6% of MMDS bandwidth
    - In-band MMDS
      - 42 MHz upstream vs 102 MHz downstream
      - With MDS, then 54 MHz vs 102 MHz
      - High upstream sectorization reduces asymmetry



# Realities

---

## – 3.5 GHz

- Upstream and downstream allocations are the same
- 16 QAM or 64 QAM downstream
- QPSK upstream with high sectorization reduces asymmetry

## – LMDS

- Upstream and downstream allocations are flexible and QPSK is used both directions

Therefore, the detailed solutions are different for each band.

# How Does Vyvo Fit Into This?

---

- Frequency agnostic
  - UHF, MDS, WCS, ITFS, MMDS, 3.5 GHz, and LMDS
  - The RF components determine the band of operation
  - The same Vyvo system is used for all of the above
    - Base station hardware, operating system, subscriber modems, training, logistics
- Optimized for wireless
  - DOCSIS+™ & Wireless -DSL Consortium



# Spectrum Regrowth

Improved vs. not improved OFDM

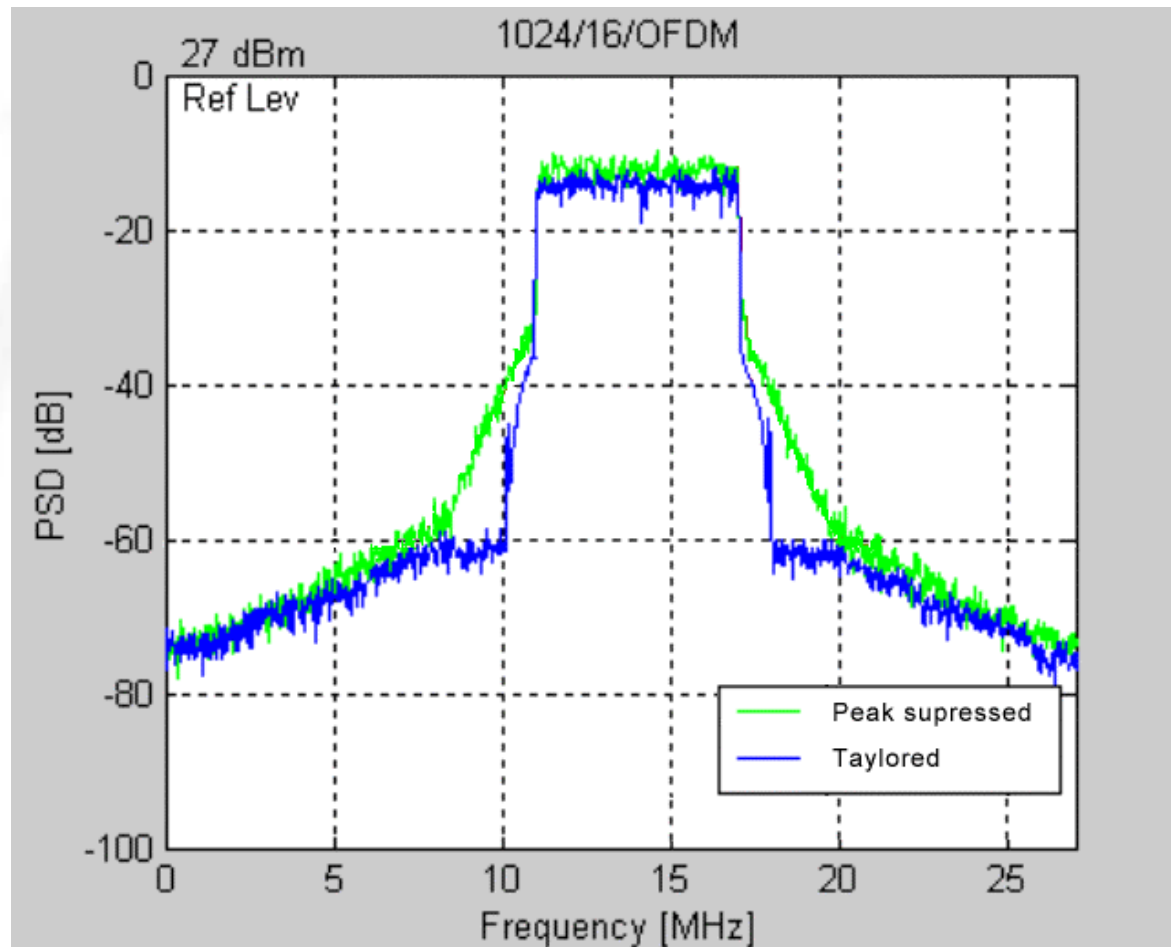

# Upstream Antenna Diversity

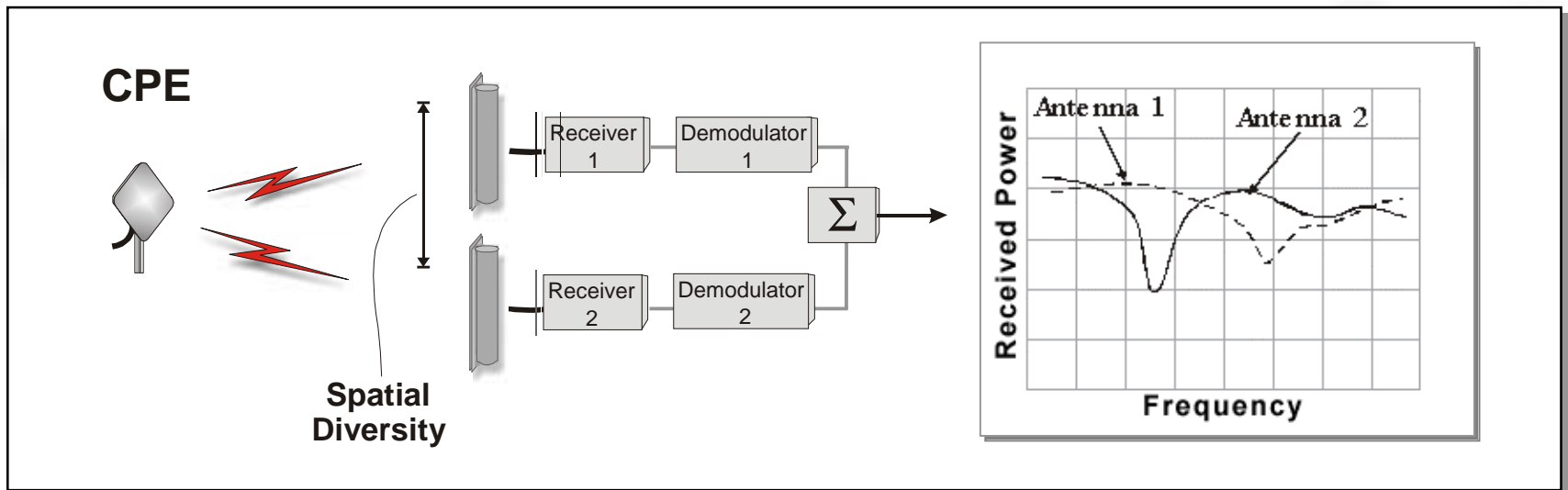

- Received signals have uncorrelated multipath fading due to different path lengths

# V3000 Modular Base Station

---

- Minimal
  - 1 Downstream and 1 Upstream
- Expanded
  - 4 Downstreams and 12 Upstreams
- Full Configuration
  - 8 Downstreams and 24 Upstreams
  - 4 Downstreams and 30 Upstreams

# Typical Configuration

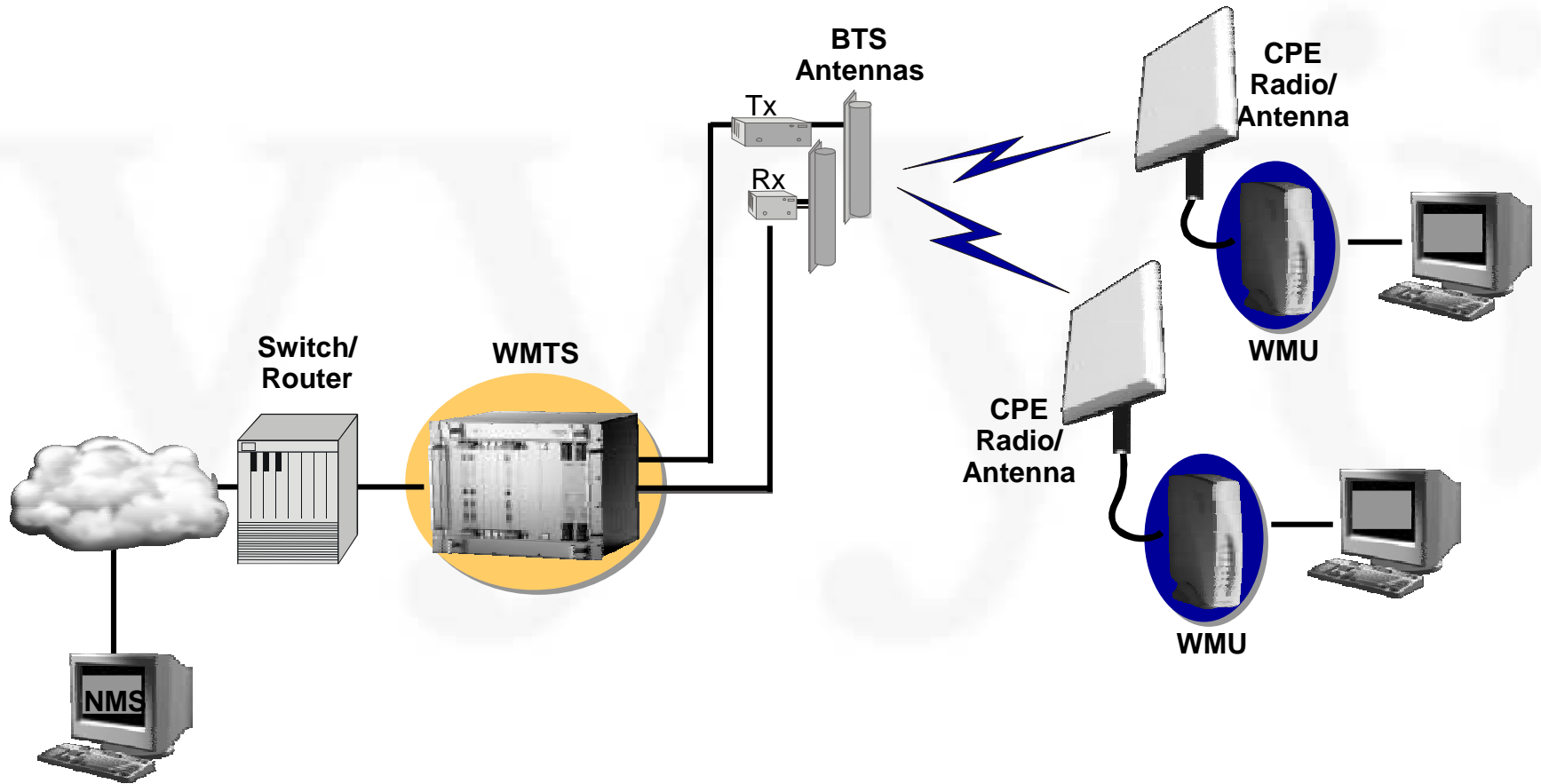

# V3000 Base Station

---

- Carrier Class Design
  - Hot Swap modules
  - Redundant Power Supplies
- Antenna Diversity
- Multiple
  - Modulation Types
  - Symbol rates (bandwidths)
  - FEC code rates
- Standards based
  - W-DSL Consortium

# Wireless Hub

- Mid-plane design
- Universal/Host cards in front
- Power Supplies in front
- Modem cards in back

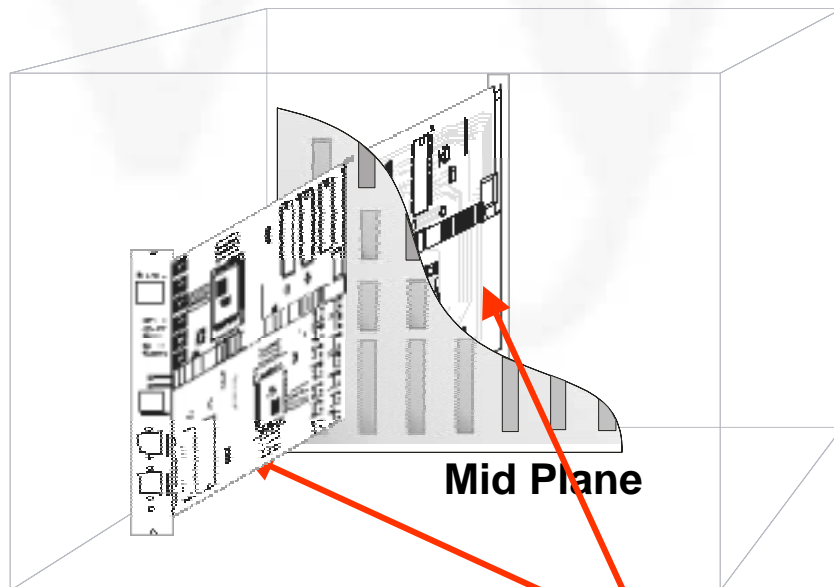

Mid Plane

Communication Module

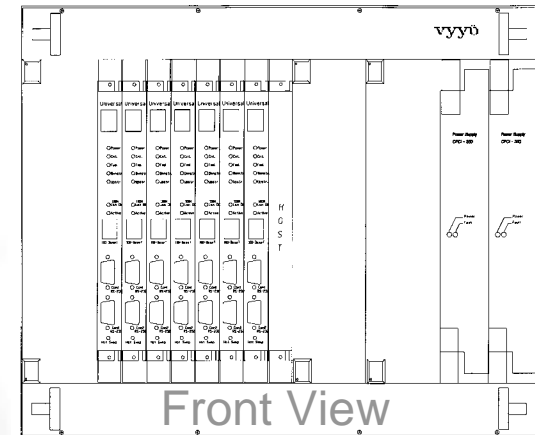

Front View

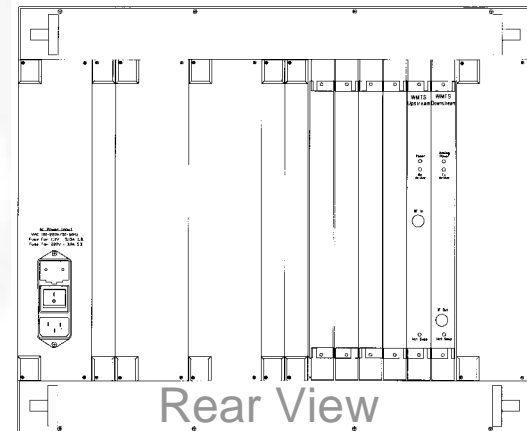

Rear View



# Summary

---

- Frequency Reuse is less important than net data rate delivered to your customers on the spectrum you hold
- Base station antenna characteristics are a fundamental consideration
- Modulation flexibility, number of channels, and linearity need to be considered
- Vyyo supplies wireless modems and base station equipment to match a wide variety of configurations

[ewilson@vyyo.com](mailto:ewilson@vyyo.com)

