

The Internet Protocol (IP) and Global Telecommunications Transformation¹

Terrence P. McGarty

Abstract

This paper presents a discussion of the impact of the Internet Protocol, namely IP, technology on the potential disaggregation of international as well as domestic telecommunications markets. There have been the proliferation of many players entering into this IP market and this combined with the many new regulatory changes, especially the WTO in the international market and the 1996 Telecom Act in the US, has allowed for the implementation of many new competitors and competing systems.

Contents

1	INTRODUCTION	3
2	THE INTERNET PROTOCOL	4
3	IP ARCHITECTURES	5
3.1	IP TELEPHONY STRATEGIC ALTERNATIVES.....	5
3.2	THE IP FOOD CHAIN	7
3.3	INTEGRATION WITH THE TELCO NETWORKS	7
3.4	IP COMPETITIVE LOCAL EXCHANGE CARRIERS (IP-CLEC).....	10
4	ELECTRONIC MARKETING AND DISTRIBUTION CHANNELS	12
4.1	PROMOTION AND PERSUASION	13
4.2	SELF SEGMENTATION	13
4.3	TRANSACTIONS, INFORMATION & ENTERTAINMENT	14
4.4	TECHNOLOGICAL IMPERATIVES.....	14
4.5	IMPACTS.....	14
4.6	POLICY IMPLICATIONS.....	15
5	THE VULNERABILITY OF INTERNET	15
5.1	LEVELS OF THREATS	15
5.2	POINTS OF ATTACK	16
5.3	TECHNOLOGICAL IMPERATIVES.....	16
5.4	POLICY ISSUES	16
6	INDUSTRY PLAYERS	17
7	ECONOMICS AND FINANCIAL STRUCTURES	18
7.1	ILD ECONOMICS	19
7.2	CLEC ECONOMICS	20
8	POLICY IMPLICATIONS	24
8.1	PRIVACY	24
8.2	PRINCIPLE OF COST BASED PRICING: ACCESS AND INTERCONNECTION	25

¹ This draft paper was presented at the Seminar on "Creative Destruction: Telecomm in Transition", Tufts University, Medford, MA, March 12, 1999. Dr. McGarty is also the CEO of Zephyr Telecommunications and is an advisor and member of the steering committee of the MIT Internet Telephony Consortium. Dr. McGarty is CEO of the Telmarc Group, LLC, mcgarty@rpcp.mit.edu.

9 CONCLUSIONS 29

1 INTRODUCTION

The Internet has been a catalyst for the development of many new technologies, services, and the key elements in the growth of many new marketing and distribution companies in the U.S. especially. Companies such as Amazon.com, ebay, buy.com, and others have created a significant market value. This value is in great part generated via the ability of the Internet to provide global connectivity in a well defined and minimalist fashion and using the simplest of technologies.

The Internet is in reality a simple facilitating channel that allows many users to interconnect with many services. The Internet has been used initially as a means to send email or to communicate and transfer files. In the last few years it has become what is best termed an electronic marketing and distribution channel.

The Internet has been evolving into a transaction medium allowing users to purchase certain goods and services and purveyors of these goods and services to market them. To date, however, the approaches have been of a limited nature. There are certain elements of the Internet that may present significant changes to commerce in general. If the Internet can become a true electronic marketing channel then the normal boundaries of selling may be dramatically changed and this may result in significant changes in the structure of retail selling.

This happened after World War II with the development of highways, suburban developments and the shopping mall. This resulted in the reduction in urban downtown markets, dislocation of jobs, and the change in certain urban markets as the workforce and the infrastructure was displaced. The question that may be asked is, was the development of shopping malls and the predecessors of the highways the cause or the effect. The answer generally is a little of both. Can true Internet retailing create a similar effect to shopping malls and again elicit a significant social re-allocation and industrial shift?

The issue is what can the Internet do to become a key element of the economic infrastructure. The answer is that it must facilitate commerce in the broadest sense, both on a domestic and international basis, and both on a commercial and consumer front. If it can facilitate the trade in goods and services then it can change the current distribution channels, distort the existing barriers to entry, open new markets and create a new class of competitors. To accomplish all of these it must have the facility to do what is essential in everyday commerce, both wholesale and retail.

The concept of the Internet becoming the key element of an economic infrastructure is driven by the concept of the Internet as the key facilitator of the electronic marketing and distribution channel, facilitating transactions and in many cases actually precipitating them.

2 THE INTERNET PROTOCOL

The essence of Internet facilitation and accessibility is the set of protocols available to the community to allow access by a wide variety of hosts in a complex and fully distributed fashion. The protocols are at the heart of Internet success. They are the "software and system agreements" that allow disparate machines and software to talk across equally disparate networks. The current protocols focus on data transactions, with some innovation allowing images and limited multimedia; namely voice and video. The future challenge will be the development of new and innovative protocols to allow both low end user access to grow while at the same time enriching the capability of the information transferred.

The key underlying protocol structure that makes the Internet function is the Transport Control Protocol/Internet Protocol, TCP/IP protocol suite. This protocol allows for the easy and ready flow of data from one user to another by agreements at various levels of the network to handle, process, manage, and control the underlying data packets. Protocols such as TCP/IP will be the heart of the evolution of the Internet. We shall focus latter on such protocols as applied to multimedia and new access methods. One can best understand the protocol evolution by looking more closely at TCP/IP. To quote Cerf:

*"IP (the Internet Protocol) provides for the carriage of datagrams from a source hosts to destination hosts, possibly passing through one or more routers and networks in the process. A datagram is a finite length packet of bits containing a header and a payload. ... Both hosts and routers in an Internet are involved in processing the IP headers. The hosts must create them ... and the routers must examine them for the purpose of making routing decisions, and modify them as the IP packets make their way from the source to the destination."*²

"TCP is a protocol designed ... to provide its clients at a higher layers of protocol a reliable, sequenced, flow controlled end to end octet stream...."

The development of new protocols can best be determined from studying the twenty year evolution of the TCP/IP protocol. The rationale for many of the TCP mechanisms can be understood through the following observations:

- 1. TCP operates above IP and IP provides only best efforts datagram transmission service.***
- 2. End to end recovery... leads to sequencing..***
- 3. Flow control requires that both ends uniquely agree...***

²See Cerf, pp. 84-85 in Lynch and Rose.

- 4. In a concatenation... it is possible for a packet to circulate...*
- 5. Termination ... should be graceful..*
- 6. Every process should be able to engage in multiple conversations*
- 7. ... the arrival of information should contain no semantic differences...'³*

These types of architectural and system requirements must be articulated as clearly and carefully for each of the new dimensions of expansion of the Internet. TCP/IP protocols have emerged as the standard network interface to the Internet that allows users to send messages from one point to another in a reliable form and also the users to embody in those messages certain characteristics that make them more than just a collection of bits. IP gets the packet across the network, and TCP brings the underlying nature of the packet stream into context as a reconstituted entity.

3 IP ARCHITECTURES

This section depicts the various options or telecommunications in the IP domain. It focuses on strategic issues and then addresses the issues of IP in the more standard domains.

3.1 IP Telephony Strategic Alternatives

This section discusses several of the alternative from an operation perspective of the IP telecommunications architectures. There are three that are now currently understood and being offered; the clear channel network approach wherein a dedicated circuit is used, the Internet backbone approach using the current Internet transport mechanism, and, for example, the proposed ATT/BT merger of the international IP which is an IP “service bureau” for other “carriers” to access their IP backbone which will provide a Quality of Service type of IP transport.

The provision of a global IP network that guarantees a quality of service, QOS, at a price point that is matched to the amount of service, its QOS, and possibly its actual usage. The IP service network approach allows the provider to become the network backbone at the IP level and that anyone interested in connecting to them must do so at IP level and not at the raw bandwidth level as is currently done today. In the current world of Internet providers, such an IP service offering is directed to the local IP Service provider and not to the carrier level. It is almost a “reseller” approach wherein the costs of service is above the EBIDTA line and not below it as a capital asset.

³Cerf, pp. 117-118, in Lynch and Rose.

This section analyzes the various architectures that may be made available to the IP telecommunications community. There are four possible extremes. The following describes these extremes. There are four extremes depending on what the interface is, clear channel or IP backbone, and what the fee structure is, fixed fee per unit access or fee per transaction (bps, packet, minute, etc.). The four extremes shown that the standard IP telephony using the Internet use an IP interface but use a fixed fee per Internet access to an ISP, say \$9.95 per month to a PSI backbone network per IP line. The ATT/BT approach is one which uses an IP interface but charge on a per transaction basis. The approach taken by companies such as Level 3, Qwest, Zephyr and others is an approach which use dedicated clear channel circuits. The interface is at the clear channel basis, namely bit per second, and they do the IP processing on their own network equipment. A fourth approach is a clear channel dial up wherein the IP is done independently. No carrier seems to use this approach at this time.

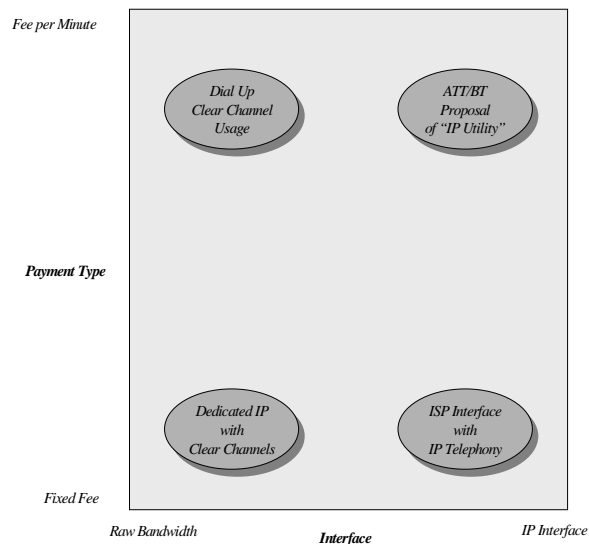

The most important point in the IP service approach is who is the responsible agent for the definition of interfaces and standards as compared to the open Internet environment of today. The offering of a fully open IP network will take a great deal of time to implement and will face significant regulatory as well as political hurdles. The first, as indicated, among them is the issue of who defines the IP interfaces and services. Currently the IP community is highly diversified and entrepreneurial and the last thing they want is an some third party telling them how to build the network.

The risks are this is the typical IBM strategy of pre-release to stall the development of any competitor networks. However, the strategy may backfire since the key here is the IP network combined with the globalization and open markets for bandwidth and the bandwidth lowering of costs on a global scale. Also the opening of most markets following the WTO agreements also opens the Pandora's Box of competition making this approach highly problematic.

3.2 The IP Food Chain

The provision of telecommunications services via IP consists of the utilization of several elements. At one end is raw bandwidth that is installed in the ground, under the water, or in the skies above. The next step leased bandwidth, such as an E1 circuit. Then there is the access to TCP/IP backbone as may be obtained by accessing the Internet. The next step is the provision of voice carriage. Finally is the customer or end user. The following Table presents the multiple players and where the play within this segmented space, also know as the IP food chain.

	Raw Bandwidth	Leased Bandwidth	TCP/IP Carriage	Voice Unit Carriage	Customer
Raw Bandwidth	Teleglobe AT&T				
	AT&T and BT or Bell Atlantic				
	AT&T				
	AT&T, MCI Worldcom				
Leased Bandwidth		ISPs			
		Zephyr (Clear Channel)			
		Zephyr (Clear Channel)			
TCP/IP Carriage			? (ITXC, GXS etc)		
			Internet Telephony Companies, Delta Three, IDT et al		
Voice Carriage				Resellers	

The above chart depicts the essence of the theory of disaggregation. The theory of disaggregation states that technology and industry has developed in such a fashion that it is possible to effect all elements of a business in a virtual form by obtaining all functions necessary to deliver a service by purchasing them from third parties each of whom has themselves other similar customers and thus each of whom can deliver their element of the functionality in a minimal marginal cost manner. The disaggregation theory then concludes with the result that in many technologically intense services business, a virtual company can exist wherein all the functions can be purchased from third parties or capital equipment may be purchased in a fully interconnected fashion so as to achieve near equality between average and marginal costs from the very commencement of the business.

3.3 Integration With The Telco Networks

The standard international telephone connection is shown in the figure below. In this case the local LEC customer goes through their local switch, which in turn has access to the SS7 data base and system. This then connects to the IXC access tandem and then via an international set of circuits possibly to an international gateway switch(s) and then to the PTT access tandem and finally to the local PTT switch which has a C7, or SS7 variant, which must via the gateway convert from one to the other.

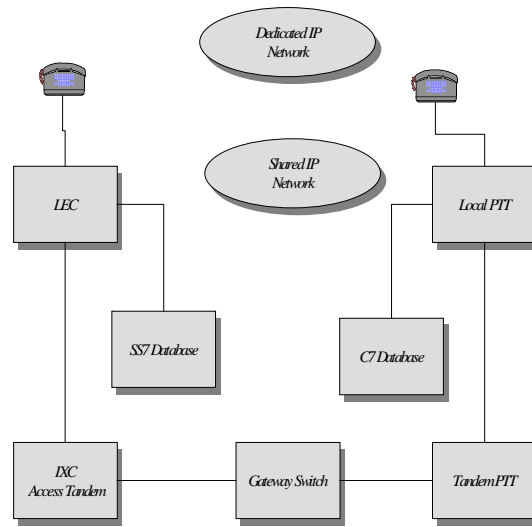

The next variant is with the use of an IP carrier. We have depicted two different types. The first is a decocted backbone IP network and the second is a shared IP backbone network. The shared is what we typically call the open Internet whereas the dedicated is the closed user Internet, sometimes called an Intranet, although this is generally reserved for a completely closed user group.

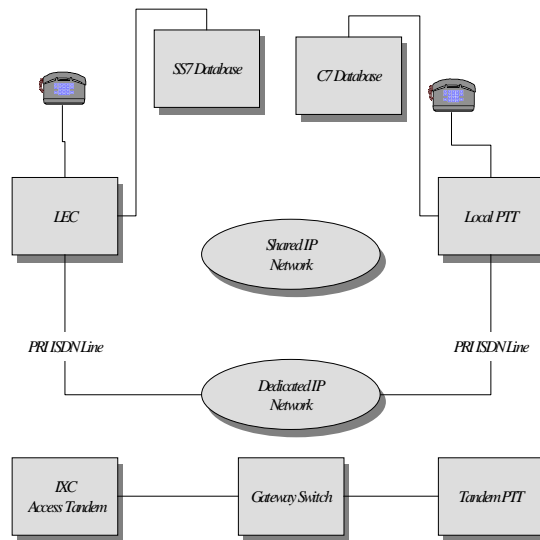

The IP carrier however is further characterized by certain elements as shown below:

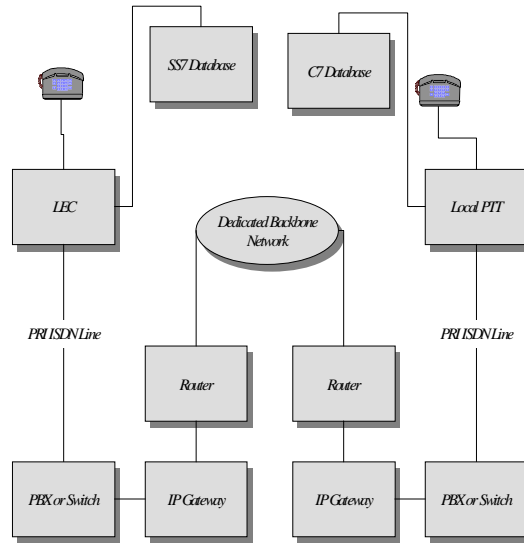

In this Figure we depict the Routers, the clear channel backbone network as well as any IP gateways. However we also depict a PBX or switch for interconnect to the LEC or PTT. This may or may not be necessary.

The following depicts a third view wherein the IP carriage is from tandem to tandem. This comes into importance when one connects via access tandems in country as one may do if one were an international record carrier.

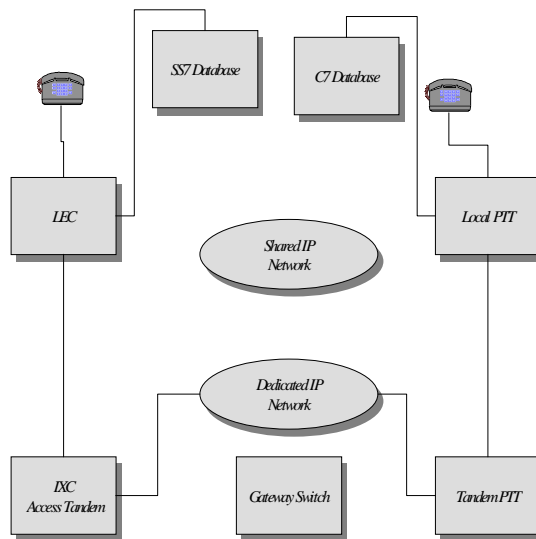

Another alternative approach is the intermediary services broker. This is shown below. Companies such as ITXC and GXC have taken this approach assuming the following:

- There are many “naive” and unconnected ISPs that need a clearing house or middleman to effect their transactions.
- That currency transactions and settlements can be done by a multiplicity of third parties.
- That third party billing, network management, and infrastructure provisioning can and must be established.
- That there will be no entry by the more typical telephone carriers into the IP telephony market.

These assumptions are critical to such an approach but they are highly problematic given the needs of this market to have telephony and telecommunications expertise.

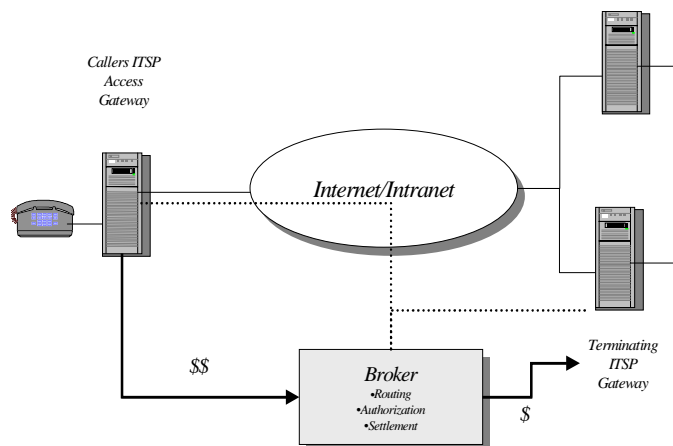

3.4 IP Competitive Local Exchange Carriers (IP-CLEC)

The CLEC market allows for the use of IP in the local domain and in the long distance, LD, domain. They use IPN, IP Nodes, that compress, switch, and manage IP telecommunications. The details of the operations of these networks are detailed elsewhere.⁴

The following figure depicts that implementation of an IP based system for LEC business.

⁴ See McGarty & McKnight, **International IP Telephony**, MIT Press, 1999, to be published.

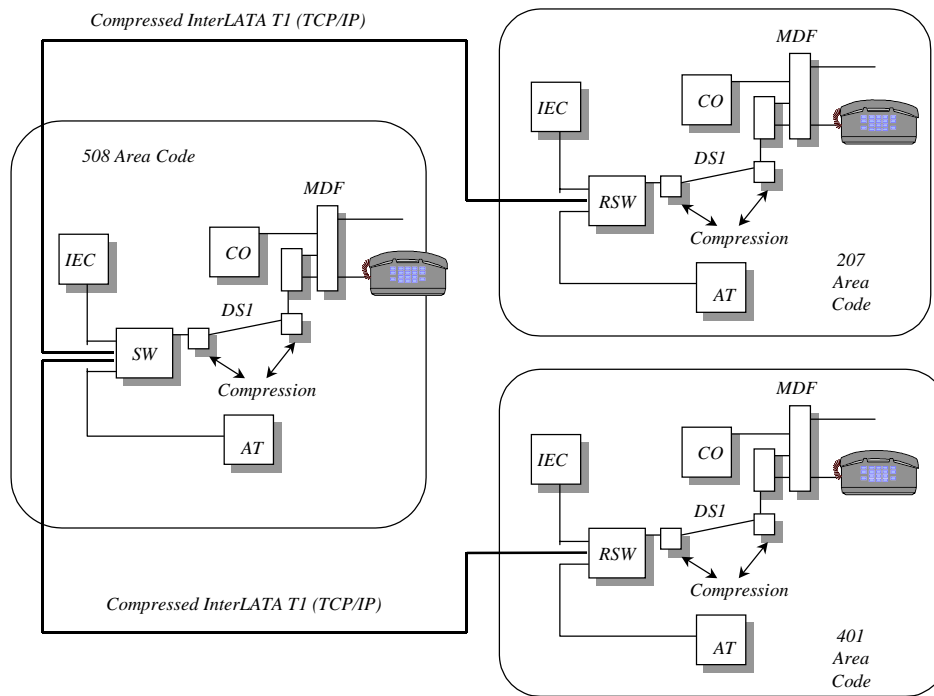

In this implementation, the provider can rapidly establish a facilities based system as follows:

- *Use the regional hub shown in the 508 Area Code as the basic location for operations.*
- *Use remote switches, RSW, such as the Tecom switch or others, that can be deployed at the 196 line multiple ratio rate with a bypass connection from a CO.*

- *Connect between the CO and the RSW via the compressed and concentrated path. This means that with a 10% Erlang load one can achieve 240 users per T1 and with 8 bit compression one achieves 8 times that number or 1920 subscribers per T1. This means that the T1 costs can be made insignificant.*
- *Use the RSW for local interconnection to the Access Tandem.*
- *Use the RSW as the means to connect back to the main switch, the SW, via a compressed T1 using both speech compression and utilization compression. Use TCP/IP on that backbone to provide inter LATA service as a valued added carrier and not as an IEC. Thus the termination on any local AT can be done under the local access tariff.*

4 ELECTRONIC MARKETING AND DISTRIBUTION CHANNELS

The Internet is a vehicle for facilitating international as well as domestic electronic marketing and distribution channels, thus dramatically altering the means and methods by which people transact.⁵ The provision of new electronic media to sell products develops an electronic marketing and distribution channel. This electronic channel has the following characteristics:

1. *Self Segmentation: The consumer may determine for themselves what they want and control may leave the hands of the purveyor.*
2. *Electronic Promotion and Persuasion: The ability to promote and persuade is challenged by now having to develop new media interfaces and sensations as to product offerings.*
3. *Electronic Transactions: This is the ability to perform online real time transactions in a secure fashion.*
4. *Displaced Selling Channels: This means that the sales channels are displaced from the point of sale. This means has been the mainstay of catalog shopping and 800 number shopping but its application to the Internet is just commencing.*

⁵ See: Papers by McGarty:

1. QUBE: The Medium of Interactive Direct Response, Direct Marketers Compendium, Direct Marketing Association (New York), pp 162-165, 1982.
2. Impacts of Consumer Demands on CATV Local Loop Communications, International Communications Conference, Boston, MA, 1983.
3. Hybrid Cable and Telephone Computer Communications, Computer Conference, Washington, DC, 1983.
4. Cable Based Metro Area Networks, IEEE, JSAC-1, November, 1983.
5. Alternative Networking Architectures; Pricing, Policy, and Competition, Information Infrastructures for the 1990s, John F. Kennedy School of Government, Harvard University, November, 1990.
- 6.

5. *Delayed Gratification: This is the observation that purchasers like to see, feel, and retrieve their purchased good at the time, place, and point of purchase. The concept of delayed gratification has been shown to have continued acceptance in catalog as well as Amazon.com type sales channels.*
6. *Automation and Integration of Sales, Delivery, and Support & Service: The ability for the customer to order and electronically allow end to end delivery may allow for a fully integrated process of sales completions such as is being attempted in the Internet auto sales. Can manufacturing and just in time principles be applied here?*

4.1 Promotion and Persuasion

The main element of establishing an electronic distribution channel is the ability to promote and persuade. This can be achieved in the current physical systems such as stores via direct human contact and the ability to set a diversity of offerings in a readily accessible format, such as the Department Store motif. However, the Internet can take advantage of the multiple media formats of video, interactive video and audio, the ability to adaptively conform the users learned interests and the ability for the seller to focus on developing a brand loyalty with the user/customer.

To effect promotion and persuasion the following are a few of the capabilities of the Internet access that will be required:

1. *Real time high quality video that can respond to the customers query for information.*
2. *Interactive real time voice and video that allow for the customer to interact with and to be interacted with a quasi sales person of service person.*
3. *Secure transaction capability integrated with interactive human interfaces.*
4. *The ability to “search” for alternatives. This will be a multimedia buy and compare capability for the consumer to seek out the best offer and offerings.*
5. *The ability to integrate “orders” into interactive just in time manufacturing, thus allowing the Internet to be the facilitator of interfaces the order process with the production and delivery process.*
6. *The facility to integrate multi country orders with currency transfers.*

4.2 Self Segmentation

Self segmentation is the concept of allowing the customer to select via an intelligent medium those things that the customer specifically wants and to eliminate the chaff of those for which there are no interests. Consumers may via this new medium, determine

what they are independent from the purveyor. How can the purveyor promote and persuade the customer to purchase collateral sales. This is the issue currently addressing Amazon.com and others, wherein the customer approaches the electronic store without Internet to purchase anything but what they specifically want. Collateral sales is an important element of retailing in its broadest sense.

4.3 Transactions, Information & Entertainment

The full impact of the commercializing of the Internet is to allow it to facilitate the complete spectrum of transaction, information and entertainment services. These can be readily mixed together, targeted at the consumer, and made more efficient for all parties.

4.4 Technological Imperatives

There are several technological developments that must be implemented in the IP domain to effect the above mentioned efforts. These are as follows:

- 1. Fully Interactive Video*
- 2. Fully Linked Toll Quality Voice*
- 3. Secure Transaction Links*
- 4. Real Time Multi Linked Data Multimedia Access*
- 5. Scripting Tools and Facilities for Multimedia Interfacing*

4.5 Impacts

There will be significant impacts from the opening of the Internet to full commercial transactions. Some of these have significant economic impacts such as:

- 1. Displacement of Business Bases due to new channels of distribution.*
- 2. Creation of Off Shore Distribution and Sales because proximity to the customer is no longer needed.*
- 3. Movement of Sales Infrastructure to Other Locations/Countries and thus the loss of economic business bases. This also means the fragmentation of elements of the now defined sales and distribution processes.*
- 4. Economic Dislocation of Certain Businesses due to the changes in cost and distribution structures.*

4.6 Policy Implications

There are many Policy issues related to this area, Some of them are as follows;

1. *Privacy of Consumer sales and profile information.*
2. *Security of Transactions from overt and covert threats.*
3. *Taxation of the sales transactions from domestic and international elements. What are the state issues, the federal issues, and WTO type issues.*

5 THE VULNERABILITY OF INTERNET

The concern of electronic attack to the Internet is an element of the more broadly defined issue of information warfare. The Internet, as an open network, is very vulnerable to attack from adversary entities. These attacks make the use of the Internet very vulnerable as any element in an economic infrastructure. Thus it will be imperative to determine how best to protect and safeguard the users.

5.1 Levels of Threats

There are multiple levels of attack to the Internet from two major directions; point of attack and type of attack. This sections presents the type or level of attack. The next section depicts the points of attack.

5.1.1 Active Attack

The Active Attack is one wherein the adversary intends to inflict direct and measurable harm to a point or set of point in the Internet. The Adversary may want to be covert or overt in their approach.

5.1.2 Passive Monitoring

The Passive Monitoring approach has an Adversary quietly monitoring any access point. This adversary may passively monitors data, transaction, trends, etc.

5.1.3 Active Monitoring

This is where an electronic adversary actively watches a transaction point in a network. The user may actually use the network for their own purposes, such use may not threaten the other users but it takes advantage of the network assets.

5.1.4 Covert Usage

This is where a users desires to covertly use a network for transactions, transmissions or other means. This may be a covert adversary who wishes to use the network assets for their covert means, a covert adversary who wishes to perform covert transactions, or a simple covert adversary using the network for transmission.

5.2 Points of Attack

There may be several points of attack on a network. These are as follows:

1. *End Point Attack; this is an attack on an end point of the network such as a router or processor. It may be a covert or overt attack on the system operations software or process control system.*
2. *Transmission Attack; this is an attack on the transmission path by either causing loss of packets, loss of control, or diversion of packets.*
3. *Switching (Router) Attack; this is an indirect attack on the switching. It may result in a diversion of traffic or in the duplication of traffic, packet, and their being sent to other locations.*
4. *Silent or Embedded Attack; this attack is the “sleeper” approach wherein an event may trigger the destruction of resources of the interference with available resources.*

5.3 Technological Imperatives

There are several technological imperatives that must be considered;

1. *Router Access Control*
2. *Access Identification and Validation*
3. *Authentication Schemes*
4. *Monitoring of Passive Attackers*
5. *Advanced Firewalling of Intermediate Nodes*

5.4 Policy Issues

Several of the possible Policy in IP network security issues are as follows:

1. *Government Control of networks when they may be under attack. What are the Governments rights to “protect” the networks. Does DoD have a right to demand that network providers “work” with them or other Government agencies and add costs to networks to meet Government Standards for attack protection.*

2. *Standards for protection from attack, who sets them, how are they delayed, who pays, and what enforcement rules apply.*
3. *Time of Attack Protocols. What happens if an attack takes place, who takes control. Who monitors the networks for overt or covert attack. What are the implications as compared to Government surveillance of private communications. At what point does the Government have a right to take over control of any network or network element?*

6 INDUSTRY PLAYERS

The following Table presents the key IP and IP like Competition and their approaches, strengths and weaknesses.

<i>Competitor</i>	<i>Approach</i>	<i>Strength</i>	<i>Weakness</i>
AlphaNet	<i>Start with Fax and become Canadian IRC</i>	<i>Strong regional Canadian Position</i>	<i>Limited Technical expertise</i>
ATT/BT	<i>Global Player</i>	<i>Everything</i>	<i>Few other than inertia and size.</i>
Delta Three/RSL	<i>An Internet player with RSL backing</i>	<i>Strong financial position.</i>	<i>Limited technology, limited technical expertise, and risky business strategy of contracts. Uses Internet as transport.</i>
Esprit ⁶	<i>Major player now merged with GTS</i>	<i>See GTS</i>	<i>See GTS</i>
GTS	<i>Dominant European player with many assets in play.</i>	<i>Great position as carrier. Good ops and marketing.</i>	<i>No IP experience and management dominated by old time telco types.</i>
GXC	<i>A group attempting to be a broker in IP telephony. Focus is in creating a clearinghouse.</i>	<i>Some funds and contacts with international ISPs.</i>	<i>No telecom or significant international experience and no infrastructure.</i>
IDT	<i>An aggressive telecom reseller.</i>	<i>Great sales and great motivation. Experience in telecom.</i>	<i>No significant experienced staff for international.</i>
ITXC	<i>A group from Microsoft with no telecom experience trying to be a clearinghouse.</i>	<i>Have raised about \$10 million and have no revenue.</i>	<i>No telecom capability and no international capability. Devoid of significant IP experience.</i>
OzMail	<i>Australian player with IP experience.</i>	<i>Great execution and coverage.</i>	<i>Limited international exposure and ownership problems of company.</i>
Primus	<i>Well financed international carrier.</i>	<i>Good presence and telecom capability.</i>	<i>Limited IP competence and focusing on selling capacity.</i>
Star Telecom	<i>Global telecom carrier.</i>	<i>Good network experience and presence.</i>	<i>Limited IP experience.</i>
StarTec	<i>Ethnic reseller.</i>	<i>Good sales and some telecom capabilities. Well motivated.</i>	<i>Limited IP experience and international operations experience.</i>
VIP Calling	<i>A small start up with no telecom experience. They are software people with money raised successfully.</i>	<i>Financing.</i>	<i>No experience internationally or in telecom. Uses Internet as backbone network</i>
Zephyr Telecommunications	<i>A start up telecommunications company focusing on international and some local domestic CLEC opportunities.</i>	<i>Small but growing international presence.</i>	<i>Strong IP capabilities with first dedicated channel services started in 1996.</i>

The growth of IP telecommunications companies is expected to be significant. The above table reflects what is known in the public domain at this time. There may be significant differences as each of these carriers evolve and mature, not to mention their ability to merge and grow more aggressively.

7 ECONOMICS AND FINANCIAL STRUCTURES

IP economics is the driving factor for its rapid acceptance. The following two sections perform a simple analysis for International Long Distance, ILD, and competitive local exchange carriers, CLECs, respectively.

⁶ Esprit has merged with GTS.

7.1 ILD Economics

The following is an analysis of breakeven and full capacity services using a dedicated network for international ILD using IP. The first analysis is a comparison for a sub-rate E1 and the second for a dedicated E1. Case 1 is for Poland and case 2 is for Russia. In the case of Poland we have:

	<i>Breakeven Sub-Rate</i>	<i>Fully Loaded Sub-Rate</i>	<i>Breakeven E1</i>	<i>Fully Loaded E1</i>
<i>Circuit Capacity MOU/Month</i>	960,000	960,000	4,800,000	4,800,000
<i>Capacity %</i>	45%	95%	15%	88%
<i>Minutes of Use/Month</i>	431,175	912,000	730,425	4,200,000
<i>Revenue</i>	\$75,456	\$159,600	\$127,824	\$735,000
<i>COS:</i>				
<i>International circuits</i>	\$29,075	\$29,075	\$55,000	\$55,000
<i>Foreign termination</i>	\$32,338	\$68,400	\$54,782	\$315,000
<i>Foreign local E-1's</i>	\$2,000	\$6,000	\$6,000	\$8,000
<i>Gross Margin</i>	\$12,043	\$56,125	\$12,043	\$357,000
<i>GM %</i>	16%	35%	9%	49%
<i>Allocation:</i>				
<i>Salaries</i>	\$7,084	\$7,084	\$7,084	\$7,084
<i>Operating expenses</i>	\$4,959	\$4,959	\$4,959	\$4,959
<i>Net Operating Income</i>	\$0	\$44,083	\$0	\$344,958
<i>NOI %</i>	0%	28%	0%	47%

A similar analysis for Russia is done below. The margins and breakeven are better in all cases.

	Breakeven	Sub-rate Fully Loaded	Breakeven E1	Fully Loaded E1
<i>Circuit Capacity MOU/Month</i>	640,000	640,000	4,800,000	4,800,000
Capacity %	49%	94%	11%	88%
<i>Minutes of Use/Month</i>	310,750	600,000	514,200	4,200,000
<i>Revenue</i>	\$40,398	\$78,000	\$89,985	\$735,000
<i>COS:</i>				
<i>International circuits</i>	\$22,500	\$22,500	\$65,000	\$65,000
<i>Foreign termination</i>	\$7,769	\$15,000	\$12,855	\$105,000
<i>Foreign local E-1's</i>	\$2,000	\$4,000	\$4,000	\$8,000
<i>Gross Margin</i>	\$8,129	\$36,500	\$8,130	\$557,000
GM %	20%	47%	9%	76%
<i>Allocation:</i>				
<i>Salaries</i>	\$4,781	\$4,781	\$4,781	\$4,781
<i>Operating expenses</i>	\$3,347	\$3,347	\$3,347	\$3,347
<i>Net Operating Income</i>	\$0	\$28,372	\$2	\$548,872
NOI %	0%	36%	0%	75%

7.2 CLEC Economics

The basic economics of the CLEC business are as follows:

- *The provider will focus on residential and small/medium business customers that are in the “doughnut” and not the “whole”, namely the provider will focus on those customers who are in a ring around the major market, in the first case, Massachusetts.*
- *The provider will through its own switch offer CLASS and Custom Calling services as well as basic calling features at a price point that is 10% to 20% lower than the I-LEC rates. Thus a customer using \$30 per month in current calling will pay \$24 per month.*
- *The provider will bundle long distance, CLASS and Custom Calling and other Services.*
- *The provider will sell CLASS and Custom Calling services, typically three per customer, at 20% less than current rates averaging \$3.00 per month thus adding another \$7.20 per month on the average bill resulting in a \$31.20 per month per residential services. The provider also provides its own voice mail platform for both the reseller and facilities based elements of the business.*
- *The provider will pay on a per access line basis \$9 per month per access line to the ILEC. It is assumed that there are 1,200 minutes per month per access line so that this is approximately \$0.0100 per minute.*

- *The provider will target Central Offices such that the provider will connect a T1 carrier from the targeted CO to its switch. The T1 will cost \$325 per month. Assuming a 50% loading, and an Erlang load of 10% per customer per month, this means that a T1 can handle 120 customers per month, or approximately \$3.00 per month per customer. Greater loading is possible and that will reduce the cost. This is approximately \$0.0025 per minute.*
- *The switch that the provider has is leased at approximately \$8,000 per month. The switch can handle 10,000 access lines at that rate. That is \$0.80 per access line per month or \$0.0070 per minute per access line. At 50% loading this is \$1.60 per access line of \$0.0140 per minute.*
- *The sales costs are approximately 15% of the gross revenue. This is \$5.00 per month per access line or approximately \$0.0020 per minute.*
- *The operations costs are the combined leased costs of the operations support systems of \$0.080 per access line or \$0.0070 per minute. In addition the billing is \$2.40 per bill per month per access line or \$0.0020 per minute.*

The net margin is shown below. Assuming no additional revenue from IEC services or any other services, this is a 10% net margin on a 20% discount. If the discount is less than 20%, then the difference basically goes to the bottom line. The following Table depicts the differences in the pure reseller market and the facilities based market.

The facilities based market is shown as in the above. In addition the Reseller approach is also shown. In the reseller approach, however, the rate reduction is 5% rather than 20%, the dominant costs factor is the cost of service which is 81% of the Gross ILEC Revenue, and one still has to deal with billing and operations as fixed costs.

000105000000000000

Element	Facilities Based			Reseller		
	Per Access Line	Per Minute	Percent	Per Access Line	Per Minute	Percent
ILEC Revenue	\$39.00	\$0.0325	125.00%	\$39.00	\$0.0325	105.26%
Revenue	\$31.20	\$0.0260	100.00%	\$37.05	\$0.0309	100.00%
Local Loop	\$12.00	\$0.0100	38.46%	\$0.00	\$0.0000	0.00%
Transport	\$4.00	\$0.0033	12.82%	\$0.00	\$0.0000	0.00%
Switch	\$1.60	\$0.0013	5.13%	\$0.00	\$0.0000	0.00%
Operations Support	\$0.80	\$0.0007	2.56%	\$0.80	\$0.0007	2.16%
Billing	\$2.40	\$0.0020	7.69%	\$2.40	\$0.0020	6.48%
Service	\$0.00	\$0.0000	0.00%	\$31.59	\$0.0263	85.26%
Net Operating Expense	\$20.80	\$0.0173	66.67%	\$34.79	\$0.0290	93.90%
Gross Margin	\$10.40	\$0.0087	33.33%	\$2.26	\$0.0019	6.10%
Cost of Sales	\$6.24	\$0.0052	20.00%	\$7.41	\$0.0062	20.00%
G&A	\$2.40	\$0.0020	7.69%	\$2.40	\$0.0020	6.48%
Net Expenses	\$29.44	\$0.0245	94.36%	\$44.60	\$0.0372	120.38%
Net Margin	\$1.76	\$0.0015	5.64%	(\$7.55)	(\$0.0063)	-20.38%

The following Table is the same comparison but now for a 3,000 per minute business line.

00001050000000000000

Element	Facilities Based			Reseller		
	Per Access Line	Per Minute	Percent	Per Access Line	Per Minute	Percent
ILEC Revenue	\$100.00	\$0.0333	125.00%	\$100.00	\$0.0333	105.26%
Revenue	\$80.00	\$0.0267	100.00%	\$95.00	\$0.0317	100.00%
Local Loop	\$12.00	\$0.0040	15.00%	\$0.00	\$0.0000	0.00%
Transport	\$4.00	\$0.0013	5.00%	\$0.00	\$0.0000	0.00%
Switch	\$1.60	\$0.0005	2.00%	\$0.00	\$0.0000	0.00%
Operations Support	\$0.80	\$0.0003	1.00%	\$0.80	\$0.0003	0.84%
Billing	\$2.40	\$0.0008	3.00%	\$2.40	\$0.0008	2.53%
Service	\$0.00	\$0.0000	0.00%	\$81.00	\$0.0270	85.26%
Net Operating Expense	\$20.80	\$0.0069	26.00%	\$84.20	\$0.0281	88.63%
Gross Margin	\$59.20	\$0.0197	74.00%	\$10.80	\$0.0036	11.37%
Cost of Sales	\$16.00	\$0.0053	20.00%	\$7.60	\$0.0025	8.00%
G&A	\$2.40	\$0.0008	3.00%	\$2.40	\$0.0008	2.53%
Net Expenses	\$39.20	\$0.0131	49.00%	\$94.20	\$0.0314	99.16%
Net Margin	\$40.80	\$0.0136	51.00%	\$0.80	\$0.0003	0.84%

We can now do the same analysis for a comparison of three options: a fiber based system using a dedicated fiber to a co-location chamber in a central office, a concentrator using a remote switch module, RSM, and a concentrated leased T1 one, and finally the IP based solution. We do this analysis for both the local service as well as the long distance service. The final metric for comparison is the effective cost per minute.

0010500000000000

<i>Cost Element</i>	Local Service			LD Service		
	<i>Fiber Based</i>	<i>RSM Based</i>	<i>IP Based</i>	<i>Fiber Based</i>	<i>RSM Based</i>	<i>IP Based</i>
Co-Location Space Lease per Month	\$500	\$500	\$500	\$500	\$500	\$500
Fiber Cost per Mile	\$150,000	\$150,000	\$150,000	\$150,000	\$150,000	\$150,000
Miles to CO	4	0		75		
Fiber Cost	\$600,000	\$0	\$0	\$11,250,000	\$0	\$0
Fiber Cost per Month	\$12,000	\$0	\$0	\$225,000	\$0	\$0
Number Effective T1s per Fiber	\$360	\$360	\$360	\$360	\$360	\$360
Effective Fiber Loading	5%	5%	5%	20%	20%	20%
Monthly Fiber T1 Costs	\$667	\$0	\$0	\$3,125	\$0	\$0
Switch Line Card Cost/Line	\$150	\$150	\$150	\$150	\$150	\$150
RSM Cost per Line		\$50	\$50		\$50	\$50
Lease Rate Line Card per Month	\$3	\$4	\$4	\$3	\$4	\$4
Mux Costs per T1 Bank	\$125	\$125	\$125	\$125	\$125	\$125
Mux Cost per Month	\$3	\$3	\$3	\$3	\$3	\$3
T1 Costs per Month		\$250	\$250		\$2,250	\$2,250
IPN Capital Costs per T1 Unit	\$0		\$20,000			\$20,000
Monthly IPN Costs	\$0	\$0	\$400	\$0	\$0	\$400
RSM Concentration Ratio	1	10	10	1	10	10
IPN Compression Ratio	1	1	8	1	1	8
Number of AL per T1	1	10	80	1	10	80
Total Costs per Month per T1	\$672	\$257	\$657	\$3,131	\$2,257	\$2,657
Number of Minutes per AL per Month	1,200	1,200	1,200	1,200	1,200	1,200
Total Minutes per month per T1	28,800	288,000	2,304,000	28,800	288,000	2,304,000
Effective Cost per Minute	\$0.0233	\$0.0009	\$0.0003	\$0.1087	\$0.0078	\$0.0012

The bottom line is as follows:

Fiber Based System: This has a local cost per minute of \$0.0233 and an LD cost of \$0.1087. We have used 5% loading for local and 20% loading for LD.

RSM Based Design: This assumes that the RSM has a local switch module in the co-location site plus uses 10:1 concentration. The local costs is \$0.0009 and the LD is \$0.0078. This is a dramatic difference. It says that putting a concentrator reduces the costs about 10:1 for the local as expected and much more so for the LD costs.

IP Based: This is the most efficient. It has the lowest local costs and the lowest, and almost inconsequential costs for long distance.

The conclusion drawn from this is that IP telephony will drive all costs down to a minimal costs base. This is why AT&T has recently announced the elimination of circuit switches in their domestic network, the use by Level 3 and Qwest of IP backbone, the AT&T and BT JV for international IP and the Bell Atlantic IP services. IP will change dramatically the costs of service and will drive up usage and down costs.

8 POLICY IMPLICATIONS

There are many policy issues that arise in the IP world; taxation, laws, intellectual property, criminal acts, transborder actions, but there are two that are of significant importance; privacy and interconnection.

Privacy simply is the ability to secure one identity, also person, in such a fashion that an individual should fear no intrusion to their “life on the net”. Interconnection means simply that any IP network should have access to any other and this is generally achieved via standards, and in the IP world these standards are minimalist in fashion.

8.1 Privacy

The issue of privacy is a key issue in telecommunications systems. From the perspective of the U.S. Constitution privacy had had a spotty history. The famous case of Griswold allowed for the “privacy” of action due to a penumbra of coverage from the Bill of Rights. In contrast the U.S. there is a significant level of privacy protection in the laws of the EU.

Privacy has two embodiments; the privacy of action and the privacy of identity. The privacy of action means that an individual has the ability to perform certain actions that are deemed personal and private without the intervention of the government. The privacy of identity means that the individual should be able to keep private their own personal information and that access to it may not be mandated by any governmental authority without just cause.

There currently are advocates and arguments both favoring and arguing against special privacy legislation for on-line commerce. The European Union passed a privacy directive that went into effect this year. It requires that consumers “get disclosure statements” on how personal information will be used and the option of preventing companies from sharing information about them. Further, any company doing business in the European Union is prohibited from sending information to countries that do not meet a threshold of protection. The U.S. is one of the nations that do not meet the European standard.

The new European directive requires that companies tell people when they collect information about them and disclose how it will be used. In addition, customers must provide informed consent before any company can legally use that data. This would be an “opt-in.” policy, rather than an “opt-out” policy where the customer is informed of the intent to collect data and the purpose to which the data is used, but the data is collected

unless the customer objects and expressly instructs the company not to. The U.S. is so far favoring a voluntary industry self-audit and policing approach, and is more disposed to an opt-out policy.

The European directive law also requires companies to give people access to information about themselves. This is not always practical. For example, a company purchases or collects data for a specific purpose (e.g. a direct mail solicitation) and does not retain the data. Because of this American officials say they disagree with giving people unconditional access to information about themselves, saying access should be allowed only if it is reasonable or practical to do so.

Under European law, each member nation is required to implement the directive by enacting its own law. Six nations have drafted or passed such laws so far. It is not clear that all European nations will actually pass regulation and/or institute such a policy. In the short term government and industry officials predict that nothing much will happen. Most countries have yet to implement their own laws to carry out the directive. And several countries, including Germany, have had tough laws in place for years, and companies have found ways to deal with the requirement. For example, in 1995 Citibank was challenged in Germany, but successfully demonstrated to the German government officials there how its system protected data in the United States, and it has since operated without conflicts.

Given that sufficient services are available with adequate privacy assurances, and no really grievous well-publicized privacy violations occur, the need for and nature of additional privacy regulation for Internet, over and above the already existing laws and regulations in the consumer protection area, are likely to remain cloudy and uncertain.

Anonymity versus privacy

One particular type of information disclosure involves the identity of the originator of a message. Notions of privacy suggest to some that there should be a right of anonymity, and anonymity may be particularly important for some types of political speech. But any such right must be balanced with the right to not interact with anonymous parties. For example: if spammers were uniquely identifiable as such, TCP transactions downloading SPAM could abort early, definitively ending SPAM as an issue. Additionally implementing reliable business transactions with the ability to resolve disputes and meet government regulations (such as taxation and money laundering reporting) often conflict with the desire for anonymity.

8.2 Principle of Cost Based Pricing: Access and Interconnection

The interconnection issue is a major factor in the deployment of any telecommunications system under the domain of the 1996 Telecommunications Act and this Act provides a significantly changed platform upon which the new entrants may operate. This section provides an analysis of the interconnect problem from the CLEC's facilities to the I-LEC,

the incumbent Local Exchange Carrier and from a CLEC to the I-LEC. As has been discussed in previous papers, the interconnect issue for a wireless carrier falls into two categories; intra-plant and inter-plant.⁷ The intra-plant issue is that between cell sites and the carriers own switch and the inter is between the carrier's switching facilities and the I-LEC's facilities. Interconnection is the physical process of connecting two discretely owned telecommunications facilities. Access is the process of compensating any carrier involved in the interconnection process. The nature of this is shown below.

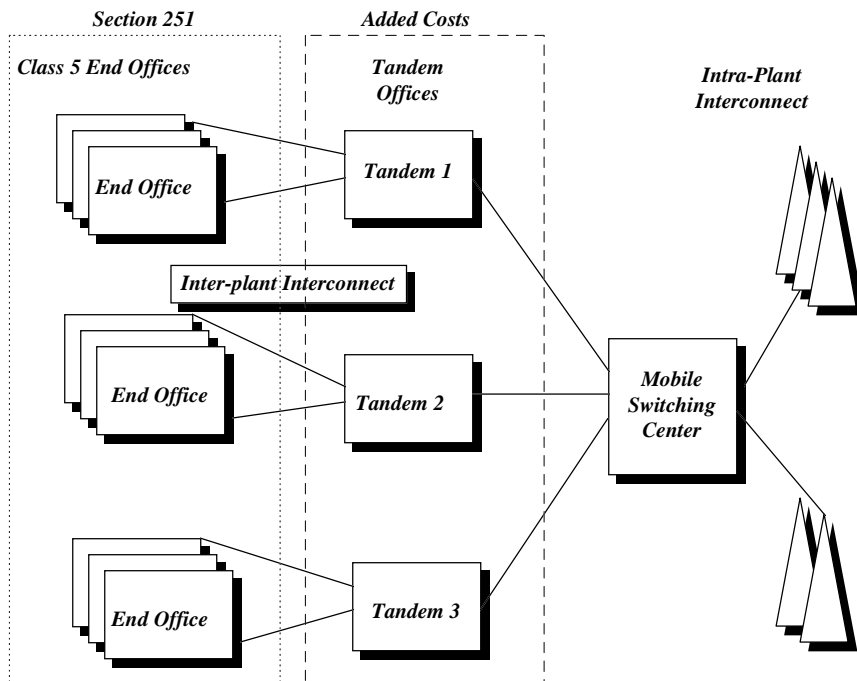

This Figure depicts three issues: first is that the intra-plant facilities are generally under the total control of the carrier. Second, that the end office I-LEC interconnect is clearly under the control of the Section 251 reciprocal compensation rule. Namely, such agreements as those between WinStar and NYNEX allow for termination of traffic here on a mutual compensation basis. Third, the real problem is how does one get from a single MSC, to several access tandems and then ultimately to dozens of end offices.

Any new carrier must be aware of these options before they interconnect since these interconnection options present significant fixed costs to the carrier and there may be ways to move these monthly fixed costs into some variable form or to move them into a form of carrier owned facilities.

A CLEC is a non-incumbent LEC. An incumbent LEC is generally a RBOC. A LEC is defined by the Act as:

⁷See the papers by McGarty in Interconnect and access. These discuss the detailed economics and the costs models. Also see the paper by McGarty, Federal Communications Law Journal. This latter paper presents a detailed antitrust analysis of the interconnection issue.

“LOCAL EXCHANGE CARRIER- The term “local exchange carrier” means any person that is engaged in the provision of telephone exchange service or exchange access. Such term does not include a person insofar as such person is engaged in the provision of a commercial mobile service under section 332(c), except to the extent that the Commission finds that such service should be included in the definition of such term.”

The definition of telephone exchange services and exchange access services is as follows:

“EXCHANGE ACCESS- As per the Act, Sec.3(b)(2), the term Exchange Access means the offering of access to telephone exchange services or facilities for the purpose of the origination or termination of telephone toll services.”

and,

“TELEPHONE EXCHANGE SERVICE - Telephone Exchange Service is defined in 47 U.S.C. Sec. 153 (r) means service within a telephone exchange, or within a connected system of telephone exchanges within the same exchange area operated to furnish to Subscribers intercommunicating service of the character ordinarily furnished by a single exchange, and which is covered by the exchange service charge.”

Exchange Services is generally the provision of toll telephone services whereas telephone exchange services is local services directly to the end user or customer.

The rates for interconnection have been established in the FCC First R&O. However this has been set aside by the Eight Federal District Court until it is reviewed. However, many of the RBOCs have already entered into interconnect agreements or are currently negotiating them. This section presents a comparison between several players in the market and presents the current pricing schedules. The requirement by the new CFR is related to local termination traffic. This is defined as:

“Local Telecommunications Traffic means: (1) telecommunications traffic between a LEC and a telecommunications carrier other than a CLEC provider that originates and terminates within a local service area established by the state commission; or (2) telecommunications traffic between a LEC and a CLEC provider that, at the beginning of the call, originates and terminates within the same Major Trading Area”

The actual interconnect agreement negotiated between NYNEX and WinStar reflects the following rates. It should be remembered that although WinStar is a wireless carrier it is not a CLEC, it is a LEC. It is a C-LEC and thus there are certain distinctions. Also, all three are common carriers, namely the I-LEC, the C-LEC and a CLEC.

The remainder of this paper presents the detail regarding the regulatory, technical and operating issues of inter carrier interconnection. It starts with the Principle of Cost Based Pricing states the following:

“The consumer of a service should pay for each element or link of service provided and purchasable separately and they should pay only for those links for which they are customers of that link provider. The payment the customer makes should reflect a price that is in turn based on the costs of that link used and that link only. There expressly should not be any element of a link price that reflects an externality that results from interconnection, interface, or similar inter-operability.”

We now can apply the principle of cost based pricing to the case on I-LEC interconnection. This Principle will be a key element in the pricing of access and interconnection. One can understand this principle by a simple analogy:

Consider the case of two towns separated by a river. At one time there was a single company, the River Transport and Travel, known as RT&T. They owned the two separate docks and the boat that crossed the river. They rented out space on the docks at end, which was deemed in the public good and for the rich people of the two towns who wanted to cross the river, they charged a premium for the boat crossing. That premium was used to subsidize the local docks and provided for Sunday entertainment and other facilities.

After many years RT&T got so big that the Governments of the two towns decided to break it apart. They let RT&T keep the boats, but insisted that a new player, New Crossing Inc., NCI, be allowed to operate a boat system in competition with RT&T. The Government then split up the two docks in Regional docks, called RDOCs. The RDOCs said they must charge the local townsfolk more money for the Sunday entertainment unless they received a fee from the inter crossing carriers, called the IXC. The Governments to keep the people happy established a fee, called the access fee that the RDOCs charged the IXCs for the “right to access” the docks. This fee was then used to support the local services and also to allow anyone in town to come to the free Sunday concerts. This was called Universal Service.

The RDOCs argued that owning a dock was a natural monopoly and that only one such dock operator could be in existence to provide services. They argued because the docks were made of hand cut stone that there were so few stone cutters that there was a law of economy of scale that demanded a single monopoly. However, about a year after this breakup a young inventor came up with the idea of plastics and cement. Now anyone could build a dock and the costs of entry were small. So after ten more years the Governments agree to allow other competitive dock providers, called the C-DOCs to enter the business. However the R-DOCs argued that all players now had a duty to support their old Sunday free concerts since this had become a right to the people and the Government agreed. They forced the C-DOCs and the IXCs to pay the R-DOCs for this service that they alone were providing.

The C-DOCs banded together after several years and said that they should charge their customers a fee that represents a fair market price for the dock service and that if

someone wanted to go to the concerts then they would have to pay the concert fee. In fact very few people wanted to go the concerts sine they were playing John Phillip Sousa band music and most of the people at this point liked heavy metal bands any how, and were going to rock concerts at the local farm yards. The C-DOCs after much litigation were allowed to charge a fee based on the free market, the IXC's were allowed to pay a fee based on what the free market allowed and the C-DOCs and IXC's prospered. The two towns then had great growth.

That is until a new inventor came up with and idea called a bridge, namely it was called the inter town network, Internet for short, that went across the river and did not use the boats. Anyone could now get across without any delay and the capacity of the bridge was much greater then the boats. The Government was very confused. It knew that its role was to regulate and it now had regulated the boat and dock businesses very well. It immediately went to regulate the bridge business in the same way.

But back in a small room, another inventor was developing something with, what she called, wings.....

This short story has all of the elements of regulation, technology, and access fees. The issue is that interconnection should where possible be open and “free”, the costs carried by the end user in some express fashion, and alternatives available based on a free open market fashion.

9 CONCLUSIONS

There are three major observations that can be made regarding the Internet and its evolution. Specifically:

There is a Convergence of Networks that allow for any one network to be integratable with any other network.

The use of IP and the ability to integrate with existing networks allows for the full global integration of multimedia, voice, data and other similar services based telecommunications facilities. It pushes the intelligence to the edge of the network and establishes a minimalist approach to network design and execution.

There is created an openness of networks and markets allowing for inter-border and inter-country exchanges and facilitating a global electronic marketing and distribution channel.

The IP based system create a true open market that is essentially borderless. This means the way we have viewed transactions and even tariffs becomes dramatically changed. The issue then is where and in what country does the transaction occur, whose taxes, whose law, and what protections does the consumer have. On the other hand it broadens global markets and allows for the growth of new electronic marketing channels.

There is a disaggregation of Services and Systems that lowers any barrier to entry and dramatically expands the Internet market for any new entrants.

The lower barrier to entry for new entrants means increased short term efficiencies that may get reflected in long term price reductions and the introduction of new services, products, and communications.