

National Aeronautics and  
Space Administration

Educational Product

Teachers

Grades 5-12

# Teachers and Students Investigating Plants in Space

*A Teacher's Guide with Activities for Life Sciences*



# Teachers and Students Investigating Plants in Space

*A Teacher's Guide with Activities for Life Sciences*

**National Aeronautics and Space Administration**

**Office of Human Resources and Education  
Education Division  
and  
Office of Life and Microgravity Sciences and Applications  
Life Sciences Division  
Washington, DC**



**With the Wisconsin Fast Plants Program  
University of Wisconsin—Madison**

This publication is in the Public Domain and is not protected by copyright.  
Permission is not required for duplication.

EG-1997-02-113-HQ

# Acknowledgments

This publication was developed for the National Aeronautics and Space Administration and the National Space Agency of Ukraine with the input and support of many individuals.

Writer:

**Paul H. Williams**  
Department of Plant Pathology  
University of Wisconsin  
Madison, WI

Editors:

**Paul H. Williams**  
**Christie M. Roden**  
**Coe M. Williams**  
**Daniel W. Lauffer**  
Wisconsin Fast Plants  
University of Wisconsin  
Madison, WI

Layout and Design:

**Christie M. Roden**

Activity Development:

**Paul H. Williams**  
**Michelle A. Graham**  
**Daniel W. Lauffer**  
**Carey K. Wendell**

The Wisconsin Fast Plants Program would like to gratefully acknowledge Bonnie J. McClain and Tom K. Scott for their contribution of the text for "The Importance of Plants in Space," and Greg L. Vogt for his contribution of the text for "Microgravity."

Special thanks to Bonnie J. McClain, Pamela L. Mountjoy and Rosalind A. Grymes for their guidance and advice.

**Wisconsin Fast Plants**  
University of Wisconsin-Madison  
College of Agricultural and Life Sciences  
Department of Plant Pathology  
1630 Linden Drive  
Madison, WI 53706  
tel: 800-462-7417 or 608-263-2634  
email: fastplants@calshp.cals.wisc.edu  
WWW: <http://fastplants.cals.wisc.edu>

# Table of Contents

## Introduction

Overview of CUE-TSIPS .....	1
Road Map: How Do I Use This Guide? .....	3
The Importance of Plants in Space .....	6
Microgravity .....	8
The Life Cycle of AstroPlants .....	10
Understanding the Environment .....	13
CUE-TSIPS Science and Technology .....	18

## CUE-TSIPS Activities

CUE-TSIPS Mission Calendar .....	29
Getting Started .....	32
Constructing the PGC, page 32	
Planting AstroPlants in the PGC, page 35	
Growth, Development and Flowering .....	37
AstroPlants Growth Group Data Sheet, page 41	
Pollination .....	43
Floral Clock Student Data Sheet, page 51	
Double Fertilization and Post-Fertilization Events .....	53
Ovule and Embryo Student Data Sheet, page 65	
Supplementary Activities:	
Germination .....	66
Orientation and Guidance .....	78

## Additional CUE-TSIPS Materials

Mission Information .....	92
Sources of Supplies .....	94
Black Line Masters .....	99
Selected References .....	101

## NASA Educational Materials

NASA Educational Resources .....	104
Evaluation Reply Card .....	107

# Overview of CUE-TSIPS

## The Collaborative Ukrainian Experiment

In May of 1995, the presidents of the United States and Ukraine issued a joint statement on cooperation in space, directing the National Aeronautics and Space Administration (NASA) and the National Space Agency of Ukraine (NSAU) to cooperate on a joint Space Shuttle mission. The United States and Ukraine announced that a Ukrainian payload specialist would fly aboard this mission, STS-87, scheduled for October of 1997. The project was named the "Collaborative Ukrainian Experiment," or "CUE."

## The CUE Science Questions

From plant science microgravity experiments on previous missions of the Russian, Ukrainian and American space programs, scientists have observed various abnormal growth and developmental phenomena in plants. The CUE projects are designed to address specific questions raised in prior experiments.

American scientists and their teams of colleagues and students, with Ukrainian scientists and their research teams, will be running 12 separate experiments as part of the science payload on STS-87. Several plant biology experiments will be run in an environmentally controlled Plant Growth Facility.

One experiment involves the controlled pollination and in-flight fixation of pollinated flowers of a special dwarf stock of rapid-cycling *Brassica rapa* (Wisconsin Fast Plants) known as "AstroPlants." A Ukrainian payload specialist will be performing these experimental procedures. The principal scientists and their question in this CUE experiment are:

Project acronym:	<b>B-STIC</b>
Investigation of:	<b>microgravity effects on pollination and fertilization</b>
Scientists:	<b>Dr. Mary Musgrave, Louisiana State University, United States Dr. Antonina Popova, National Academy of Science of Ukraine</b>
Question:	<b>What developmental events during plant reproduction fail to function normally in the microgravity environment?</b>

This question is part of the more general question: how will plants grow and function in microgravity considering that they have evolved and existed in an environment of the Earth's gravity?

## The CUE Education Project: TSIPS

As a part of the total CUE mission, an Education Project has been established with the Wisconsin Fast Plants Program at the University of Wisconsin in Madison and the National Academy of Science of Ukraine, through the Ukrainian Junior Academy of Science in Kiev. The Education Project involves teachers and students in both countries and is called "TSIPS" - Teachers and Students Investigating Plants in Space.

During the same time as the joint Space Shuttle flight, students throughout the United States and Ukraine will be undertaking experiments to determine what is normal for biological events or stages in the life cycle of AstroPlants under the Earth's gravity. Seedlings of other plants may also be used to

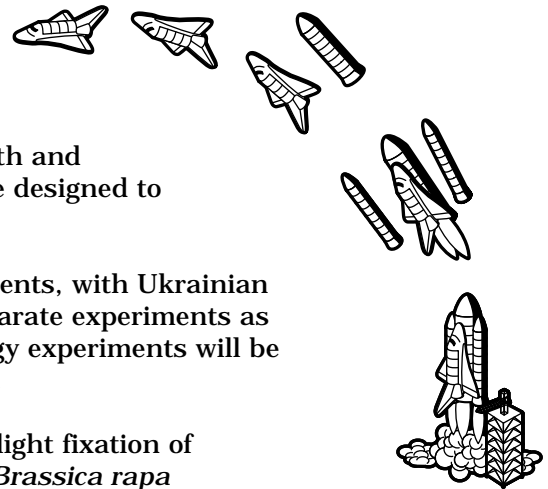

examine the effects of gravity and light on orientation and guidance in plants. The information that students gather will provide them with the basis for understanding a number of biological phenomena and principles, including phenotypic expression, variation, growth, orientation, reproduction and embryogeny. Students can compare their observations with those made in the microgravity environment by the CUE researchers.

## The Central CUE-TSIPS Experiment

The CUE-TSIPS activities have been designed to address mainly those questions raised in the B-STIC investigation of Drs. Mary Musgrave and Antonina Popova, relating to the effects of microgravity on plant growth and reproduction.

The CUE-TSIPS activities center on the Science Exploration Flowchart (page 20). Students will grow AstroPlants through a life cycle, and in the process will become well acquainted with germination, orientation, growth, flowering, pollination, fertilization, embryogenesis and seed development.

Students will gain insight into the life cycle of AstroPlants by making many careful observations, measuring and recording what they observe, and organizing and displaying data in a way that they can make analyses. The data will provide both you and your students with a better understanding of what is "normal" development in AstroPlants and will serve as the basis for comparison with data taken by the CUE investigators to help determine what developmental events during plant reproduction are affected by microgravity.

## The Science-Technology Partnership

Perhaps more than any other endeavor, experiments in space illustrate the essential interdependency of science and technology. Vast technological resources are marshalled in the execution of space-based science. Because of this interdependency of science and technology, the CUE-TSIPS project has emphasized both by including the design and construction of the experimental equipment as part of the science activities (page 19). Throughout the activities teachers are provided with instruction on how to engage students in this construction.

## The CUE-TSIPS Questions

Are there any basic life processes that will be affected by microgravity in a way that will result in altered function? What are the significant growth processes that can be identified and observed under the conditions of microgravity?

### 1. *Impact of the environment on a model organism.*

Much of what the CUE flight and ground experiments will be about is coming to understand the many environmental variables that impact on the growth and development of the model organism, the AstroPlants. This stock was developed to grow rapidly under specified environmental conditions, in an apparatus with limited volume and restricted energy inputs.

### 2. *Microgravity.*

If microgravity affects one or more life processes in AstroPlants such that deviation from the normal phenotype can be observed, then questions may be posed and research undertaken, leading to an understanding of how the processes are being affected.

### 3. *What is "normal"?*

How would you define "normal"? In order to determine what the effects of microgravity are on AstroPlants, it is important to have an accurate understanding of how they grow under standard environmental conditions on Earth.

# Road Map: How Do I Use This Guide?

The lessons in this guide can be used to engage your students in the fascination of space biology through plant investigations long after the CUE Space Shuttle mission has entered the history books. It is NASA's goal that the information in these pages will motivate both you and your students to become active and involved participants in the Space Life Sciences enterprise, now and in the future.

## 1. The CUE-TSIPS teacher guide.

- The CUE teacher guide is written for the teacher. Where "you" is used in the text, it refers to the teacher.
- The target audience for the CUE-TSIPS experiments is one of high school biology teachers and middle school life sciences teachers and their students.
- The CUE-TSIPS activities are intended to be run in "real time" with the NASA Space Shuttle flight, STS-87, scheduled for lift-off in October, 1997.

## 2. The plants being used for the CUE-TSIPS activities.

- A special genetic stock of Wisconsin Fast Plants called "AstroPlants" is used in the CUE-TSIPS activities.
  - AstroPlants are the research organisms being used by scientists for the Shuttle experiment that is the central CUE-TSIPS experiment for students and have been used in previous flights.
  - AstroPlants have a rapid life cycle and have been genetically selected to be very short, fitting within the limited space of the Shuttle Plant Growth Chambers (PGCs).
- Basic Fast Plants seed, as opposed to AstroPlants seed, will also work for the CUE-TSIPS experiments, however:
  - the plants will grow over the top of the student PGC, and
  - data on plants from the basic seed will be compiled separately from the AstroPlants data.
-  Activities focused on germination (page 66) and orientation (page 78), are supplementary to the mission and may be done with other kinds of seeds (turnip, lettuce, alfalfa). These activities are marked with the bean symbol.

## 3. Performing the CUE-TSIPS activities.

- The central CUE-TSIPS activities focus on specific segments of the AstroPlants life cycle:
  - growth, development and flowering,
  - pollination, and
  - double fertilization and embryo development.
- If you have not used Fast Plants previously:
  - a trial run before the "real time" activities is advised, and
  - to be successful you must understand the biology of the plants and the importance of creating an environment conducive to growth. Essential reading includes "The Life Cycle of AstroPlants," "Understanding the Environment," and the background sections from "Growth, Development and Flowering," "Pollination" and "Double Fertilization and Post-Fertilization Events" (see Table of Contents).

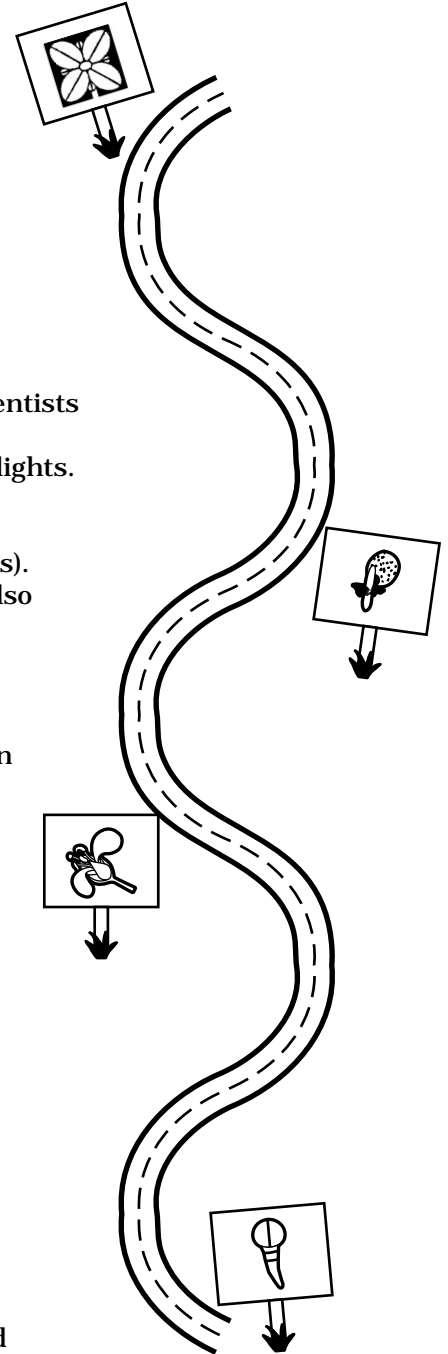

- For the "real time" activities you and your students will:
  - provide the proper growing environment (lighting, nutrient, temperature, etc.),
  - construct the Plant Growth Chamber (PGC) from low-cost, readily available materials to simulate growing conditions on the Space Shuttle,
  - plant the AstroPlants in the PGC,
  - grow the AstroPlants through the entire life cycle, and
  - complete the AstroPlants Growth Data Sheets and Floral Clock Data Sheets.
- The "CUE-TSIPS Mission Calendar" (page 29) provides a clear day-to-day guide and schedule for the activities.
- Teachers may wish to customize the data keeping, depending on the age and ability level of their students.

For teachers:

The most important guidance items in this book are:

- "Understanding the Environment" (page 13), and
- the "CUE-TSIPS Mission Calendar" (page 29).

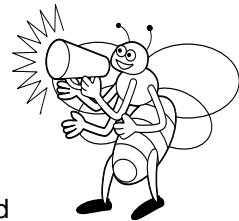

#### 4. The supplementary activities.

- For students to fully benefit from the CUE-TSIPS experiments, the supplementary activities (7 to 11) in the "Germination" and "Orientation and Guidance" sections should be carried out prior to the experiments on reproduction.
- These activities are particularly rich in quantitative biology and mathematics.

#### 5. Post-mission follow-up.

- Class summary statistics from the AstroPlants Growth and Floral Clock Class Data Sheets can be sent to the Wisconsin Fast Plants Program for compilation with data submissions from other classrooms in the United States and Ukraine (see page i for the mailing address).
  - Data will be entered for compilation only if specified environmental growing conditions have been met and recorded on the Class Data Sheets.
  - Parameters that must be reported with the data are:
    - ▲ irradiance (number of fluorescent bulbs, wattage, distance of plants from bulbs),
    - ▲ temperature of the growing environment (average daily temperature),
    - ▲ nutrient solution used,
    - ▲ root medium (e.g., specific soil or soilless mixture),
    - ▲ seed type (AstroPlants or basic Fast Plants), and
    - ▲ plants grown in a student PGC or in another capillary wicking system.
  - Data for compilation must be received by January 31, 1998.
  - Results will be posted on the Wisconsin Fast Plants World Wide Web site at the time of the National Science Teachers Association National Convention in April, 1998.
- Teachers complete evaluations by either:
  - completing and mailing in the printed "Teacher Reply Card" at the end of this guide, or
  - using the NASA EDCATS on-line forms (the "Teacher Reply Form," [http://ednet.gsfc.nasa.gov/edcats/teacher\\_guide](http://ednet.gsfc.nasa.gov/edcats/teacher_guide) and the "Plant Experiment Follow-Up Form," [http://ednet.gsfc.nasa.gov/edcats/fastplants\\_report.html](http://ednet.gsfc.nasa.gov/edcats/fastplants_report.html)).

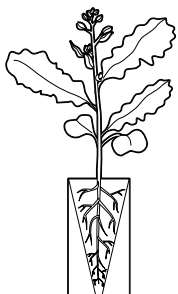

### Activity Matrix: Standards and Skills

Use the matrices on page 5 to align the CUE-TSIPS activities to the National Science Standards and Benchmarks. In each matrix, the teacher guide sections are listed along the left edge. If the activities in a given section fulfill a listed standard or include the development of a listed skill, the activity is marked with the symbol "✓" in the appropriate column. The section entitled "CUE-TSIPS Science and Technology" provides the foundations for experimentation and is aligned with many aspects of the content standards.



## Science Standards

	<i>Science as Inquiry</i>	<i>Physical Science</i>	<i>position and motion of objects</i>	<i>properties of objects and materials</i>	<i>Unifying Concepts and Processes</i>	<i>change, constancy and measurement</i>	<i>evidence, models and explanation</i>	<i>Science and Technology</i>	<i>abilities of technological design</i>	<i>understanding science and technology</i>	<i>Science in Personal and Social Perspectives</i>	<i>science and technology in local challenges</i>
Growth and Development	✓					✓		✓		✓		
Pollination	✓		✓			✓		✓		✓		
Fertilization	✓		✓	✓	✓	✓		✓		✓		
Germination	✓		✓		✓	✓	✓	✓	✓	✓		
Orientation	✓	✓	✓			✓	✓	✓	✓	✓		

## Mathematics Standards

	<i>Problem Solving</i>	<i>Communication</i>	<i>Reasoning</i>	<i>Connections</i>	<i>Number Relationships</i>	<i>Computation and Estimation</i>	<i>Patterns and Functions</i>	<i>Statistics</i>	<i>Probability</i>	<i>Geometry</i>	<i>Measurement</i>	<i>Functions</i>	<i>Trigonometry</i>
Growth and Development		✓		✓	✓	✓		✓			✓		
Pollination		✓		✓	✓	✓					✓		
Fertilization		✓		✓	✓	✓		✓			✓		
Germination	✓	✓	✓	✓	✓	✓		✓			✓		
Orientation	✓	✓	✓	✓				✓		✓	✓		

## Science Process Skills

	<i>Observing</i>	<i>Measuring</i>	<i>Communicating</i>	<i>Collecting Data</i>	<i>Inferring</i>	<i>Predicting</i>	<i>Making Models</i>	<i>Making Graphs</i>	<i>Hypothesizing</i>	<i>Interpreting Data</i>	<i>Controlling Variables</i>	<i>Defining Operationally</i>	<i>Investigating</i>
Growth and Development	✓	✓	✓	✓	✓	✓		✓	✓	✓	✓	✓	✓
Pollination	✓	✓	✓	✓	✓	✓			✓	✓	✓	✓	✓
Fertilization	✓	✓	✓	✓	✓	✓		✓	✓	✓	✓	✓	✓
Germination	✓	✓	✓	✓	✓	✓		✓	✓	✓	✓	✓	✓
Orientation	✓	✓	✓	✓	✓	✓	✓		✓	✓	✓	✓	✓

# The Importance of Plants in Space

Contributed by Bonnie J. McClain (Purdue University Grantee, Education Programs Coordinator, NASA Space Life Sciences) and Tom K. Scott (Senior Scientist, NASA Space Life Sciences).

The relationship between plants and humans has always been a close and interdependent one. Research about basic plant processes helps in understanding and augmenting this interdependence. Ground-based investigations yield information vital to this understanding; however, the knowledge gained from plant research in space is exciting and extends potential for new discoveries beneficial to humans.

There is abundant evidence that microgravity affects virtually every aspect of plant growth. Space flight provides the only known environment in which fundamental biological processes and mechanisms can be studied in the absence of the sometimes overriding effects of gravity. Removal of the effects of gravity for long periods of time allows new perspectives in the study of plants.

Answers to important questions about the basics of plant growth and development lie in understanding the role gravity has on plant processes and responses to the environment. For example, gravitropism is the bending response of plants to the force of gravity with the roots growing downward and the shoots growing upward. Charles Darwin began experiments on plant gravitropism during the nineteenth century, yet the mechanisms of this process are still not clear. The more knowledge generated about how plants function, the more likely we can adapt that information into practical, useful new applications and products enhancing life on Earth and in space.

NASA's research with plants in space is dedicated to systematic studies that explore the role gravity plays at all stages in the life of higher plants. Research focuses on the interaction of gravity and other environmental factors with plant systems, and uses hypergravity, simulated hypogravity, and microgravity as tools to advance fundamental knowledge of plant biology. Results of the research contribute to NASA's efforts to further human exploration of space and to improve the quality of life on Earth through applications in medicine, agriculture, biotechnology and environmental management.

NASA's plant science research questions focus on five objectives:

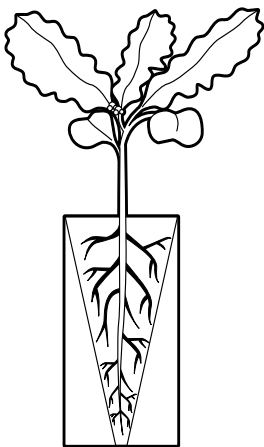

- to explain the basic mechanism whereby plants perceive, transduce, and respond to gravitational force (example: comparisons of seedling vs. older plant responses to gravity);
- to understand the role of gravity and microgravity in developmental and reproductive processes in plants (examples: flower development and wood formation);
- to learn how metabolic and transport processes are affected by gravity and microgravity (examples: photosynthesis and long and short distance sugar transport);
- to analyze interactions of microgravity with other important parameters of space (examples: cosmic radiation and electromagnetism); and
- to study the role of plants within recycling life support systems for space exploration (examples: carbon dioxide production and oxygen revitalization).

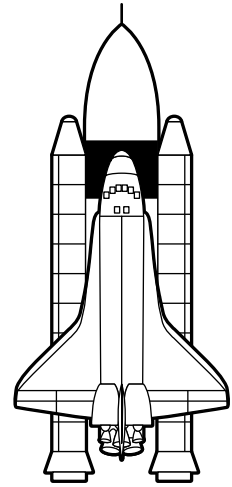

Knowledge of physiology, cell biology, biochemistry and molecular biology of plants coupled with biotechnology advances contributes to our fundamental knowledge of plants and provides impetus for a new era of plant investigations. The opportunity to experiment at a micro level of gravity provides a new dimension that enables interdisciplinary plant research to answer important questions about the plant's reception of the gravity signal, the plant's biochemical interpretation of that signal, and how that interpretation causes a developmental reaction. It appears that this reaction system, in general, interacts with receptor systems that detect both internal and external signals. It is for this reason that understanding the role of mechanical signals, such as gravity, assumes such significance for plant science: these investigations could begin to reveal the precise control mechanisms involved in dictating plant form, structure, and function.

Understanding how basic processes can be manipulated and put into use in new ways that develop new products and increase productivity is the basis for biotechnological applications in agriculture, horticulture, and forestry. For example, understanding the interaction between gravity and light could be the basis for genetic engineering of plants resulting in increased crop productivity while minimizing the required growing space. Application to horticulture could include the ability to control plant form, and forestry could benefit from faster methods of regeneration of lost forest areas.

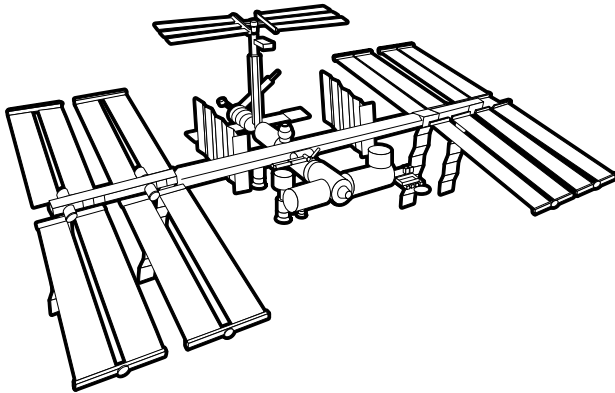

Before the first lunar outpost, the proposed Mars base, and other future missions from planet Earth can become realities, numerous scientific and technological problems remain to be solved. None of these problems is more important than that of supporting human life in space. Extended duration human exploration missions will require life support capabilities beyond those now available. A solution is to develop technologies that integrate physical and chemical processes into a dynamic, recycling life support system.

Studying plants in space will provide the scientific information necessary for development of such a life support system. Plants will be a primary component of atmospheric regeneration: carbon dioxide exhaled by humans will be taken up by plants and used in photosynthesis, in the process returning oxygen and food to the crew. Plants are also important in water regeneration. The productivity of plants relative to the input of energy (light) can be increased by using such techniques as carbon dioxide enrichment and hydroponics. To achieve a controlled life support system, ground-based research in growth chamber facilities will be conducted along with plant investigations in the microgravity environment of space flight.

Why study plants in space? The discoveries made, lessons learned, and technologies developed from these investigations will benefit those of us on planet Earth as we unlock and utilize gravity's mysteries to enhance our journey into space.

# Microgravity

Contributed by Greg L. Vogt (Crew Educational Affairs Liaison, NASA Johnson Space Center).

Gravity is an attractive force that is a fundamental property of all matter. Whether an object is a planet, a feather or a person, each exerts a gravitational force on all other objects around it. Physicists identify gravity as one of the four types of forces in the universe (the others are strong and weak nuclear forces and electromagnetic force).

The strength of the attraction between two objects is directly proportional to the product of the masses of those objects and inversely proportional to the square of the distance between the centers of mass of those objects: in other words, the larger the objects the stronger the attraction between them and the greater the distance between the objects the weaker the attraction. When measured at the surface of the Earth, the acceleration of an object acted upon only by Earth's gravity is commonly referred to as "1 g" or "unit gravity." This acceleration is approximately 9.8 meters per second squared ( $m/s^2$ ).

On Earth, gravitational force is important in providing orientation and guidance to many forms of life including plants. For example, plants orient themselves with gravity so that shoots grow up and roots grow down and water and nutrients are transported through the plants against the pull of gravity.

Although gravity is a force that is always with us, its effects can be greatly reduced by the simple act of falling. NASA uses the term "microgravity" to refer to the condition that is produced by a "free fall."

The diagram at the right illustrates how a condition of microgravity is created. Imagine riding in an elevator car to the top floor of a very tall building. At the top, the cables supporting the car break, causing the car and you to fall to the ground. (In this example we discount the effects of air friction on the falling car.)

Since you and the elevator car are falling together, you feel like you are floating inside the car. In other words, you and the elevator car are accelerating downward at the same rate. If a scale were present, your weight would not register because the scale would be falling too. You would be experiencing free fall or what astronauts call "microgravity." The ride is lots of fun until you get to the bottom!

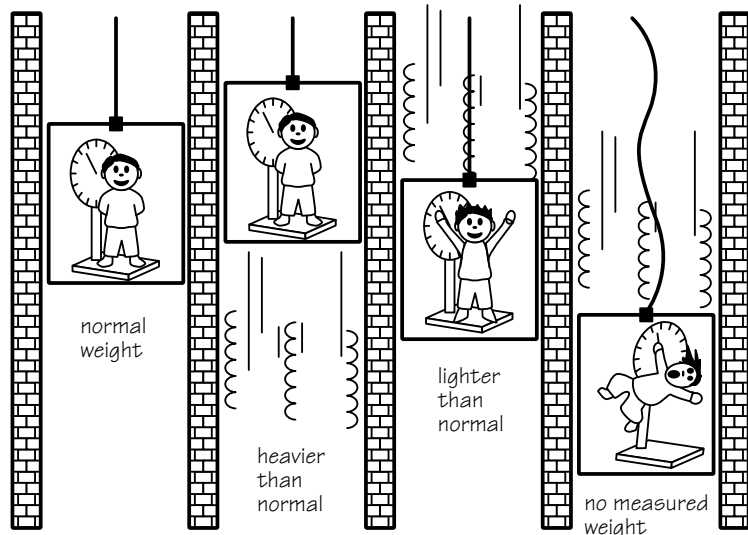

The term microgravity can be interpreted in a number of ways, depending upon context. The prefix "micro-" ( $\mu$ ) is derived from the original Greek "mikros," meaning "small." By this definition, a microgravity environment is one that will impart to an object a net acceleration that is small compared with that produced by the Earth at its surface. Another common usage of micro- is found in quantitative measurement, such as the metric system, where micro- means one part in a million. In practice, net accelerations will range from about one percent of the Earth's gravitational acceleration (aboard aircraft in parabolic flight) to about one part in a million (aboard the Space Shuttle orbiter).

NASA uses airplanes, drop towers and small sounding rockets to create a microgravity environment for experimental purposes. In each facility, an experimental payload is put into free fall that lasts from a few seconds to several minutes. Eventually, free fall ends because the object will impact on the Earth's surface.

When scientists want to conduct experiments in microgravity for longer durations – days, weeks, months or even years – it is necessary to travel into space and orbit Earth. Having more time available for experiments means that slower processes and more subtle effects can be investigated. Today, the Space Shuttle and special satellites are the space facilities that provide opportunities for these microgravity experiments. The International Space Station will soon be an important additional means of accomplishing such investigations.

### Orbiter Orientation

To obtain the most consistent microgravity environment in space, the Space Shuttle orbiter is oriented in a tail-down position. This is called the "gravity gradient mode." The tail of the orbiter is closer to the Earth and feels a stronger pull of gravity than does the more distant nose of the orbiter.

The difference in the strength of the attraction between the nose and tail has a stabilizing effect on the attitude of the orbiter. This means that the on-board crew is able to keep the orbiter stabilized with fewer corrective firings of the reaction control rockets (thrusters). Each firing produces an acceleration that interferes with the microgravity environment of the Space Shuttle.

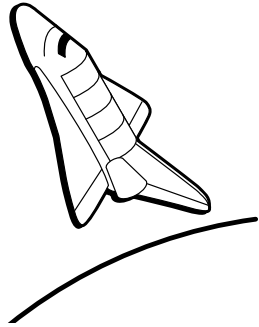

#### Microgravity Activity

You can demonstrate a microgravity environment and the effects of freefall in the classroom. Collect an aluminum soft drink can, a nail, about 12 ounces of water and a waste basket.

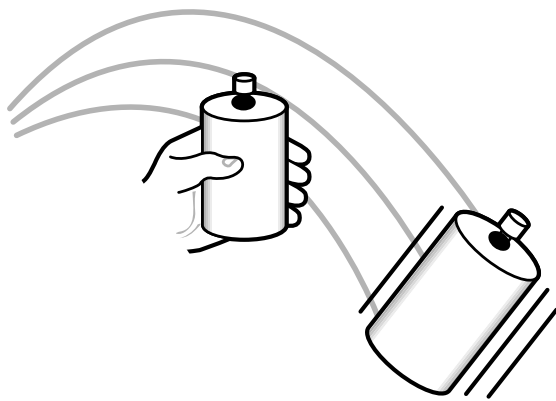

Punch a small hole in the lower side of the can with the nail, about 0.75 cm up from the bottom. Hold the can with one end so that your thumb covers the hole.

Keeping your thumb tightly covering the nail hole, fill the can with water and position the waste basket below. You may wish to stand on a chair to gain a higher can altitude.

Slide your thumb off the hole so that a stream of water is visible to all. Then drop the can. The water stream stops. Why?

In free fall, gravity's local effects are reduced.

During the fall, no force is at work pulling the water out of the hole. The water and the can fall at the same rate, just as in the falling elevator example. The water is in the condition of microgravity, experiencing free fall (Vogt and Wargo, Eds., 1992).

The Collaborative Ukrainian Experiment provides many unique opportunities for understanding the effects of gravity and microgravity on plants.

# The Life Cycle of AstroPlants

What are AstroPlants? AstroPlants are a special form of the species *Brassica rapa* (Wisconsin Fast Plants), a member of the mustard or cabbage family Cruciferae. Crucifers are distinguished by characteristic flowers with four petals in the form of a cross or crucifix. Other forms of *Brassica rapa* include turnips, Chinese cabbage, pak choi and canola. Some related crops in other *Brassica* species are cabbage, broccoli, collard, cauliflower and mustard.

## Life Cycle Concepts and Questions

### Beginning the Life Cycle: Growth, Development and Flowering

Germination is the awakening of a seed (embryo) from a resting state. It involves the harnessing of energy stored within the seed and is activated by components in the environment. Growth represents increase in size, number and complexity of plant cells and organs. Environment and genetics play fundamental roles in regulating growth. The energy for growth comes from photosynthesis.

Flowering is the initiation of sexual reproduction. The generation of male and female gametes (sperm and eggs) is one of the primary functions in flowering. The plant prepares for pollination by producing flowers. Each part of the flower has a specific role to play in sexual reproduction. The flower dictates the mating strategy of the species.

- *What are the main components of the environment necessary for germination?*
- *How does the seedling orient itself?*
- *What enables the emerging plant to shift its dependency from stored energy to the energy from light?*
- *What is the role of the environment in regulating plant growth?*
- *How do plants grow?*
- *How does a plant know when to produce leaves and when to produce flowers?*
- *Why does a plant have flowers?*

### Pollination

Pollination is the process of mating in plants. In flowers, pollen is delivered to the stigma through a wide range of mechanisms that insure an appropriate balance in the genetic makeup of the species. In brassicas, pollen is distributed by bees and other insects. The flower is the device by which the plant recruits the bee. Bees and brassicas have evolved an interdependent relationship.

- *How do flower parts function to influence mating behavior?*
- *How does the flower recruit the bee?*
- *How does pollination occur?*
- *How does the flower discriminate between self and nonself in the mix of pollen?*

### Double Fertilization and Post-Fertilization Events

Fertilization is the final event in sexual reproduction. In higher plants, two sperm from the pollen grain are involved in fertilization. One fertilizes the egg to produce the zygote and begin the new generation. The other sperm combines with the fusion nucleus to produce the special tissue (endosperm) that nourishes the developing embryo. In some plants endosperm nourishes the germinating seedling. Fertilization also stimulates the growth of the maternal tissue (seed pod or fruit) supporting the developing seed.

- *What is unique about fertilization in flowering plants?*
- *What is endosperm and what is its relationship to the embryo?*
- *How does an embryo develop into a seed?*
- *How does the maternal parent contribute to the developing embryo?*

# Growth of AstroPlants

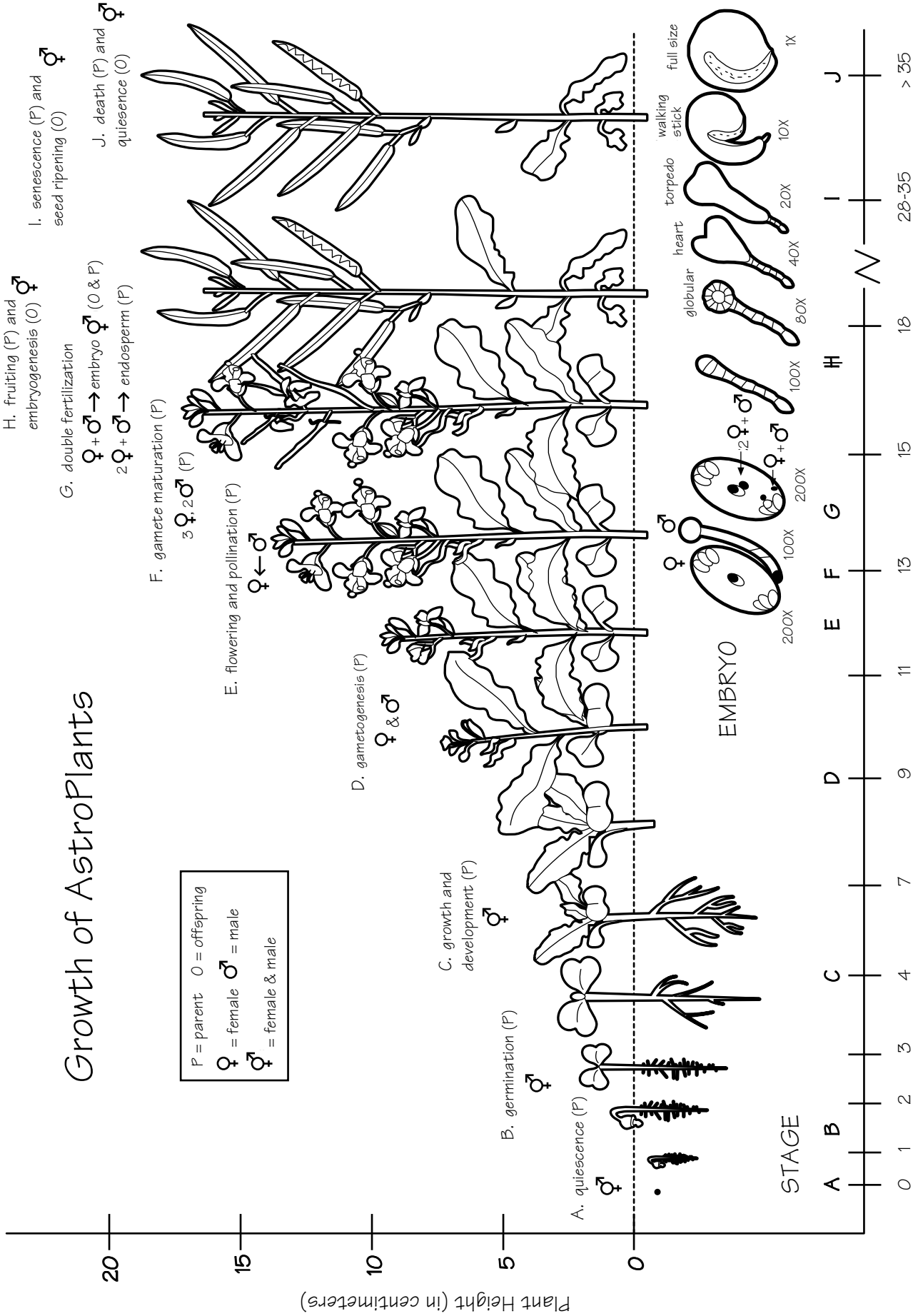

## Stages in the Life Cycle of AstroPlants: Concepts of Dependency

Stage	State	Condition	Dependency
A. seed	<ul style="list-style-type: none"> <li>quiescence (dormant embryo)</li> </ul>	<ul style="list-style-type: none"> <li>suspended growth of embryo</li> </ul>	<ul style="list-style-type: none"> <li>independent of the parent and many components of the environment</li> </ul>
B. germinating seed	<ul style="list-style-type: none"> <li>germination</li> </ul>	<ul style="list-style-type: none"> <li>awakening of growth</li> </ul>	<ul style="list-style-type: none"> <li>dependent on environment and health of the individual</li> </ul>
C. vegetative growth	<ul style="list-style-type: none"> <li>growth and development</li> </ul>	<ul style="list-style-type: none"> <li>roots, stems, leaves grow rapidly, plant is sexually immature</li> </ul>	<ul style="list-style-type: none"> <li>dependent on environment</li> </ul>
D. immature plant	<ul style="list-style-type: none"> <li>flower bud development</li> </ul>	<ul style="list-style-type: none"> <li>gametogenesis — reproductive [male (pollen) and female (egg)] cell production</li> </ul>	<ul style="list-style-type: none"> <li>dependent on healthy vegetative plant</li> </ul>
E. mature plant	<ul style="list-style-type: none"> <li>flowering</li> <li>mating</li> </ul>	<ul style="list-style-type: none"> <li>pollination — attracting or capturing pollen</li> </ul>	<ul style="list-style-type: none"> <li>dependent on pollen carriers; bees and other insects</li> </ul>
F. mature plant	<ul style="list-style-type: none"> <li>pollen growth</li> </ul>	<ul style="list-style-type: none"> <li>gamete maturation</li> <li>germination and growth of pollen tube</li> </ul>	<ul style="list-style-type: none"> <li>dependent on compatibility of pollen with stigma and style</li> </ul>
G. mature plant	<ul style="list-style-type: none"> <li>double fertilization</li> </ul>	<ul style="list-style-type: none"> <li>union of gametes</li> <li>union of sperm (n) and egg (n) to produce diploid zygote (2n)</li> <li>union of sperm (n) and fusion nucleus (2n) to produce endosperm (3n)</li> </ul>	<ul style="list-style-type: none"> <li>dependent on compatibility and healthy plant</li> </ul>
H. mature parent plant <i>plus</i> embryo	<ul style="list-style-type: none"> <li>developing fruit</li> <li>developing endosperm</li> <li>developing embryo</li> </ul>	<ul style="list-style-type: none"> <li>embryogenesis — growth and development of endosperm and embryo</li> <li>growth of supporting parental tissue of the fruit (pod)</li> </ul>	<ul style="list-style-type: none"> <li>interdependency among developing embryo, endosperm, developing pod and supporting mature parental plant</li> </ul>
I. aging parent plant <i>plus</i> maturing embryo	<ul style="list-style-type: none"> <li>senescence of parent</li> <li>maturation of fruit</li> <li>seed development</li> </ul>	<ul style="list-style-type: none"> <li>withering of leaves of parent plant</li> <li>yellowing pods, drying embryo</li> <li>suspension of embryo growth, development of seed coat</li> </ul>	<ul style="list-style-type: none"> <li>seed is becoming independent of the parent</li> </ul>
J. dead parent plant <i>plus</i> seed	<ul style="list-style-type: none"> <li>death, desiccation</li> <li>seed quiescence</li> </ul>	<ul style="list-style-type: none"> <li>drying of all plant parts, dry pods will disperse seeds</li> </ul>	<ul style="list-style-type: none"> <li>seed (embryo) is independent of parent, but is dependent on the pod and the environment for dispersal</li> </ul>



# Understanding the Environment

Three broad categories of environmental components interact to influence all life: 1) physical, 2) chemical and 3) biological. Understanding the many environmental factors and how they interact with each other to influence life is essential for good investigative science and is the key to successful experimenting with AstroPlants. In space life science investigations such as the CUE, scientists and engineers have worked together to develop technology that will create an environment to support normal plant growth within the hostile external environment of space.

Some environmental factors influence plant growth more than others. If one or more factors is reduced or increased such that normal functioning is disrupted, that factor is said to be *limiting*. When a factor that can be quantified becomes limiting, its observed effects can also be quantified.

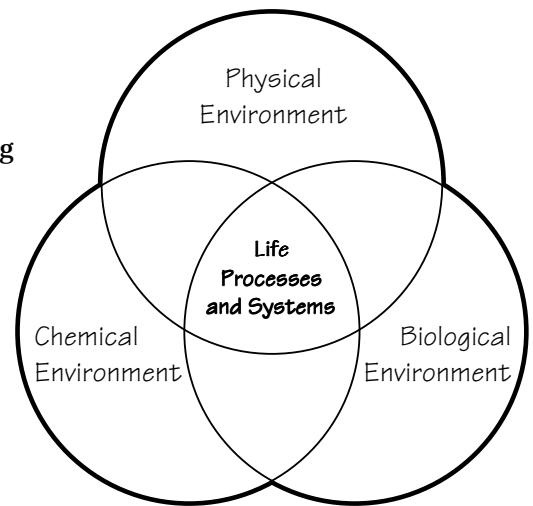

## The Physical Environment

### Light

Appropriate lighting is perhaps the most critical component of a plant's growing environment. Plants use energy from various regions of the visible spectrum to perform a number of functions essential to their growth and reproduction. Some seeds require red light to activate germination. Blue light is important for regulating elongation of stems and in guiding the direction of plant growth. Red and blue are the primary energy levels used for photosynthesis, whereas red and far red are important in the regulation of leaf expansion and certain pigment production systems.

Light for AstroPlants is produced by fluorescent lamps which emit a mix of photons in the visible range that appear as white with warm (red) or cool (blue) tones in the mix. The quantity of photons reaching a surface is known as *irradiance* or *photon flux density* and is measured in micromoles ( $\mu\text{M}$ ) or microEinsteins ( $\mu\text{E}$ ) of photon flux per square meter per second.

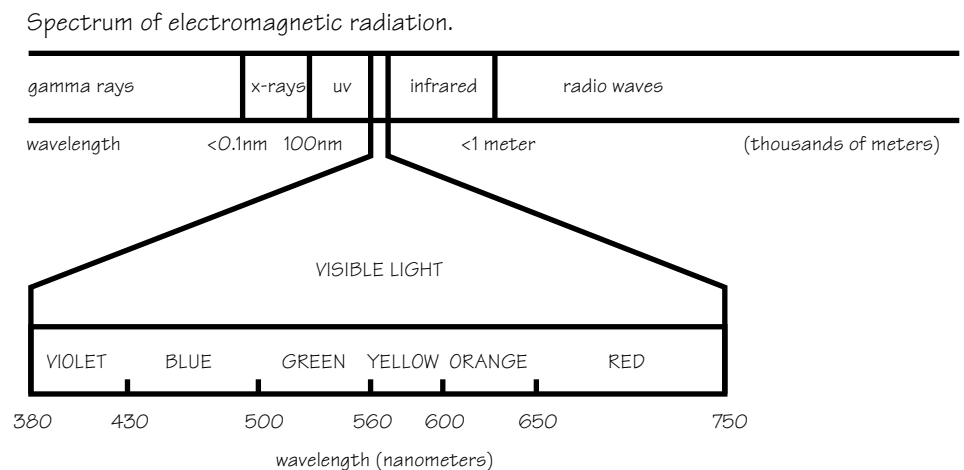

Irradiance of greater than  $200 \mu\text{Em}^{-2}\text{s}^{-1}$  is ideal for AstroPlants. Less than  $100 \mu\text{Em}^{-2}\text{s}^{-1}$  is inadequate.

As with other electromagnetic forces and gravity, the inverse square relationship applies to light. That is, if the distance between the source of light and the receiving surface doubles, the intensity of the irradiance diminishes by a factor of four.

If you are using the standard four-foot Fast Plants light bank, you can use either eight 40 watt cool white or six of the newer 32 watt high efficiency bulbs which will require different fixtures than the 40 watt bulbs. Six 32 watt Sylvania Optron® 4100K FO32/741 bulbs spaced within two feet will produce ideal lighting for AstroPlants.

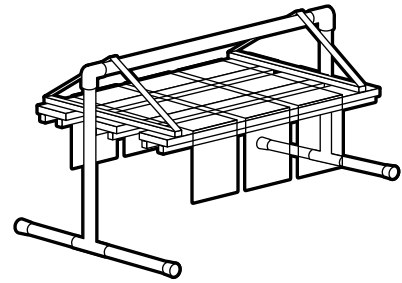

Fluorescent "circle" lamps can be suspended above and will adequately irradiate the plants growing within a circle of 30 cm diameter (12 inches). The Wisconsin Fast Plants Program has had the most successful growth under 30 or 39 watt circular or "folded" circular bulbs.

Reflectors made from aluminum foil or reflective mylar (available from fabric or stationery stores) greatly increase the irradiance reaching the plants, particularly those around the edges of the lamps. Aluminum foil "curtains" (15 cm x 25 cm) taped on the lamp fixture to hang down to about the soil level will contribute to uniform lighting across the plants.

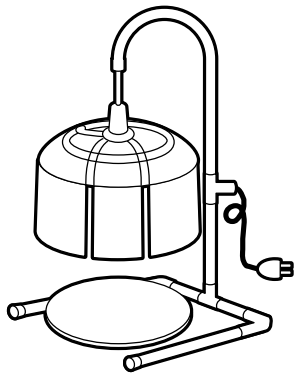

**Tips:**

- Keeping the AstroPlants under constant 24 hour light will produce the most satisfactory results. Be sure to make arrangements (with custodians, etc.) so light banks are not turned off at any time.
- Bulbs should be kept 2 cm to 3 cm above the top of the experimental Plant Growth Chamber lid (page 32). Ideally the growing tips of the plants should be kept 5 cm to 10 cm from the lights. The height of the Plant Growth Chamber (PGC) lid will keep your seedlings about 15 cm from the bulbs. This is adequate provided reflective curtains are used.

Formula for growing successful AstroPlants – **LIGHTING** :

eight 40 W bulbs or six 32 W high efficiency bulbs, <i>lighting 24 hours a day</i>	+	use reflective foil curtains	+	keep top of PGC lid 2 to 3 cm from the lights	=	<b>Healthy AstroPlants</b>
--	---	---------------------------------	---	--	---	--------------------------------

**Temperature**

The temperature of the AstroPlants' growing environment will have an important influence on the growth of your plants. Temperatures that are too high or too low can affect the timing of developmental events such as seedling emergence and flowering. Optimal temperature is between 22°C and 28°C (72°F to 82°F).

**Tip:**

- Temperatures can be monitored under each bank using hi-low thermometers. Note fluctuations in the room temperature and variation in temperature among light banks.

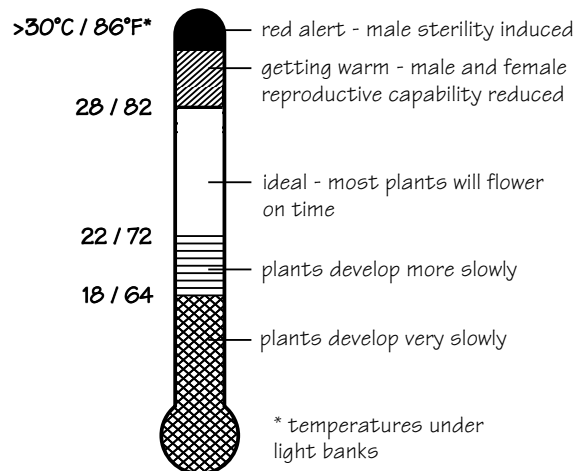

## Gravity and Microgravity

Of the many environmental factors that impact on life, *gravity* is one that exists on Earth with the greatest constancy (page 8). Gravity is an environmental factor that is difficult to vary experimentally without the support of space technology. Microgravity is what the CUE experiments are all about!

## The Soilless Root Medium

In the CUE-TSIPS activities, a mixture of one part peat moss and one part vermiculite, known as *peatlite*, serves as the root medium that anchors the plant roots, providing support for the stem and leaves. Physical characteristics of the root medium must be such as to provide adequate capillary wicking of water to the absorptive surfaces of the root hairs and epidermal cells, yet there must also be adequate channeling within the matrix of the root medium to enable air exchange for oxygen diffusion to the growing roots. Under conditions of unit gravity, peatlite provides ideal capillarity and air channeling for AstroPlants.

## The Chemical Environment

### Water

Water functions in many ways in plants, serving as the primary solvent supporting life's metabolic processes, generating *turgor pressure* (water pressure) for cell enlargement and growth, maintaining ionic balance and providing cooling via transpiration.

Water is also the source of hydrogen reducing power when it is split by light energy in photosynthesis. Water enters the plant primarily through the root epidermis and hair cells, traveling through intercellular space and cortical cells to the xylem tissue where it is distributed throughout the plant.

Within the root zone, water is found adhering to soil particles as a continuous film created through the *cohesive* forces of the water molecules. The *adhesive* forces that attract water molecules to the surfaces of soil particles and plant root cells pull the water into the minute channels within the soil and plant tissues via *capillarity*.

In the PGC, capillary wicking material is used to pull water from a reservoir to the root medium which has strong capillary properties. There is an unbroken continuity of water from the soil into and throughout the plants (see figure at right). Through this water course, the plant also gains access to inorganic nutrients. On Earth, gravity acts as a vertical counter force opposing the cohesive forces of water and adhesive forces of capillarity.

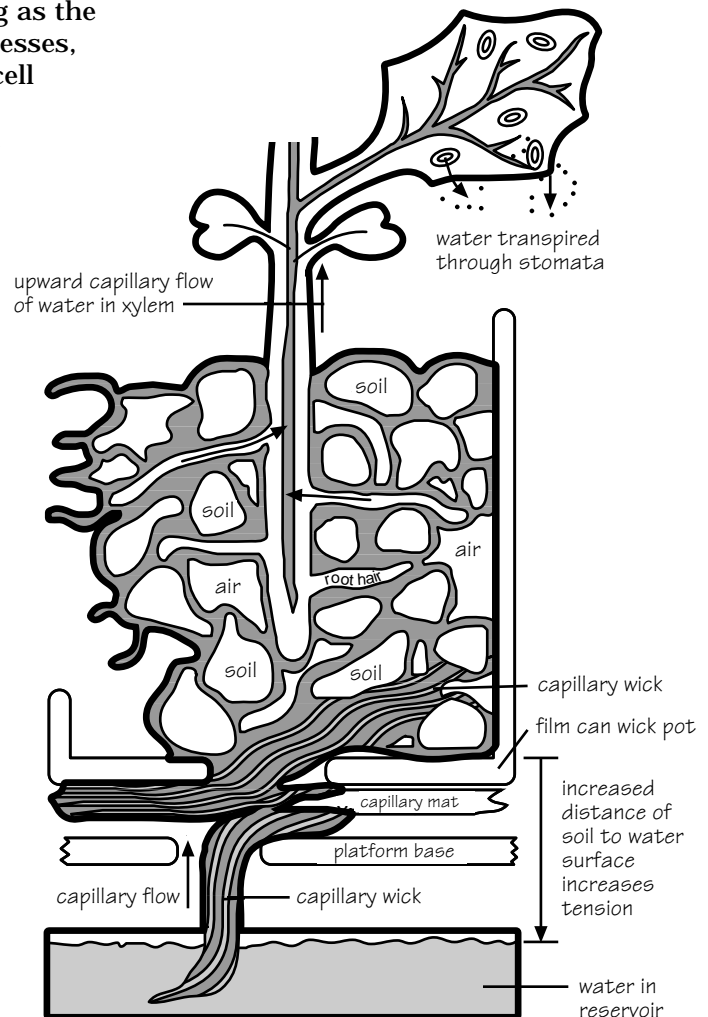

## Atmospheric Relative Humidity

The atmospheric relative humidity of a classroom can affect the rate of *transpiration* and water uptake by plants. Under low relative humidity there can be rapid water uptake from the reservoirs. When reservoirs run dry, capillarity is broken and plants will desiccate and die. When plants begin to wilt, it is an indication that transpiration is exceeding water uptake. In some climates this occurs when there has been a rapid drop in atmospheric relative humidity. In these cases plants usually adjust by reducing transpiration and regaining their turgor pressure.

If wilting persists when using the PGC, check the reservoir and examine the capillary wicks and matting to be sure they have not dried out and broken the capillary connection between roots and reservoir.

If the atmospheric relative humidity is very high (>95% RH), mature anthers in flowering AstroPlants may fail to open (dehisce) to expose their pollen. This occurs when plants are grown in closed containers in which the relative humidity builds up. It can be remedied by circulating air over the plants with a fan; mature anthers will then usually dehisce within a few minutes.

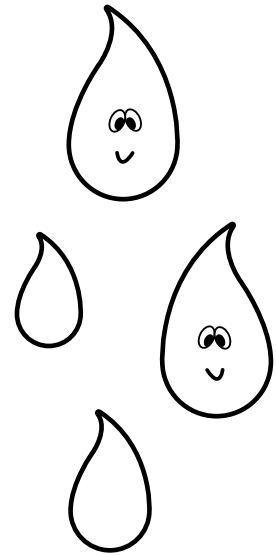

## Inorganic Nutrients

In addition to the elements carbon, oxygen and hydrogen which make up the main structure of organic compounds in plants, 13 other elements are required to support the range of metabolic processes that constitute life. Six elements – nitrogen, potassium, calcium, phosphorus, magnesium and sulfur – are known as *macronutrients* because they are required in relatively greater quantities than the seven *micronutrients* – iron, chlorine, copper, manganese, zinc, molybdenum and boron (Raven, Evert and Eichorn, 1992).

In the CUE-TSIPS experiments, inorganic nutrients are added to the root media as Wisconsin Fast Plants Nutrient Solution (page 96). Nutrients can also be added as commercially available fertilizer, such as Peters® 20-20-20 N-P-K (page 96).

Formula for growing successful AstroPlants – NUTRITION :

water + air + inorganic nutrients (6 major and 7 minor) = Healthy AstroPlants

## Atmosphere

Ambient air contains nitrogen (78%), oxygen (21%), hydrogen and helium (<1%). Carbon dioxide in air is approximately 350 parts per million and is the primary source of carbon incorporated into organic molecules via photosynthesis. In closed systems such as the Space Shuttle orbiter, where humans and other organisms are respiring, CO<sub>2</sub> may build up to toxic levels. Plants have the potential role in space flight of extracting CO<sub>2</sub> from the air and converting it into edible biomass. In the Space Shuttle orbiter, CO<sub>2</sub> levels are carefully monitored and excess removed from the atmosphere by chemical trapping in filters.

# The Biological Environment

## Types of Organisms

There can be many types of organisms associated with the plant's environment, from algae to insects. These organisms may reside together in various *symbiotic* relationships, from mutually beneficial to *parasitic* (one partner benefits) and even *pathogenic* (one partner harms the other). Some symbioses may be strictly neutral. Controlling undesirable organisms in the plants' environment requires continuous attention. Possible residents include:

- various soil *microflora* (bacteria, fungi) and *microfauna* (nematodes, worms, insect larvae) which may colonize the root zone or *rhizosphere*;
- *phytophagous* (plant-eating) arthropods which may be found on stems, leaves and flowers (mites, thrips, aphids, leaf-eating beetles, moth and butterfly larvae);
- the larvae of fungus-eating (*mycophagous*) flies which may exist in large numbers, emerging from the root medium and water mat as small black gnats; and
- various algal populations which may live on the moist root media, capillary wicking material and in the nutrient solution reservoirs. Most common are blue-green algae (*cyanobacteria*) on root media and mat surfaces and green algae in reservoirs.

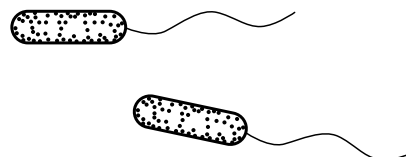

## Controlling Undesirable Organisms

**Fungi and Bacteria:** Fungi and bacteria rarely attack the above-ground parts of plants as long as the relative humidity is less than 95% and there is good air flow. The best control for fungi and bacteria is sanitation. Be sure to use pathogen-free root media – most commercially available peatlite mixtures are sanitized and pathogen-free. Keep the root media well aerated and drained by not packing it in the growing containers. After growing, it is important to rinse, then soak all pots, reservoirs, capillary mats and wicks for at least 30 minutes in a 10% chlorine bleach solution. Do not reuse root media.

**Insect Pests:** The continuously illuminated plants can be attractive to many insects, especially at night. Daily surveillance and removal of insects is good practice. Sticky yellow pest control cards work well to trap incoming insects and flies emerging from the soil. The sticky strips available from garden stores can be cut and stapled to bamboo grilling skewers and mounted in film cans filled with sand and placed among the plants. These are very effective for white flies, aphids, fungus gnats and thrips.

If colonies of aphids, white flies or thrips appear or evidence of larval feeding is observed (holes chewed in leaves or flowers), plants may be sprayed with insecticidal soap or another safe chemical control agent. Read labels carefully before applying chemicals. Surveillance and careful removal by hand is the best control practice.

**Algae:** The most common residents with AstroPlants are algae. Most do not affect plant growth but can become unsightly and occasionally will build up in reservoirs and wicking to consume nutrients and retard water flow. Algae growth can be suppressed by adding copper sulfate ( $\text{CuSO}_4 \cdot 5\text{H}_2\text{O}$ ) to the nutrient solution at a final concentration in the reservoir of between 50 and 100 parts per million (milligrams/liter).

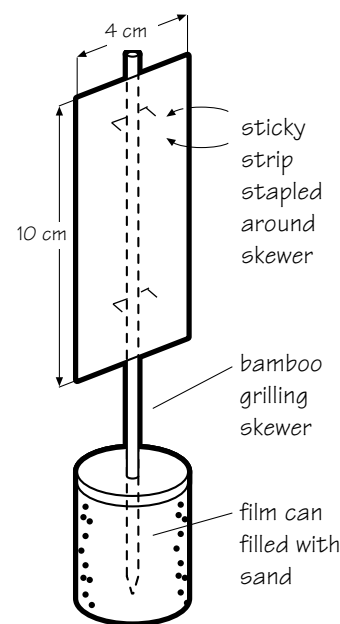

# CUE-TSIPS Science and Technology

Science begins when a person of any age is curious about something and begins to question and explore the relationships of a phenomenon to his or her understanding of the world. The scientific process begins with an observation and questions and proceeds through a process of inquiry involving exploration, investigation, experimentation and analysis, and communication and persuasion. That process engages the creative energy of the individual and leads to deeper understanding, a sense of pleasure and increased self-worth. Even young children quite naturally say: "Look what I found!"

Dr. Mary Musgrave and Dr. Antonina Popova are successful scientists who are curious about the growth of plants in space. Their interest is broad, but the questions they are asking in the CUE are very specific. They are successful as scientists because they pay a great deal of attention to the details of the questions they ask and to the design and execution of the experiments they have run to test their questions. They are both analytical and critical in their approach to the science they do; before they accept an answer to their questions, they want rigorous proof that there are not more plausible alternatives. Indeed, many scientists believe that they come closest to an understanding of what is true through an exhaustive quest which seeks, yet fails, to disprove a hypothesis. This chapter deals with many of the essentials that will lead you and your students through the discipline and pleasure of good science.

As the result of microgravity experiments run on previous missions from the former USSR, from the Russian, Ukrainian and U.S. space programs, in which the gravitational force was about one million times less than on Earth, Drs. Musgrave and Popova have observed various abnormal growth and developmental phenomena in plants. The CUE B-STIC experiments are designed to address aspects of the more specific question: what developmental events during pollination, fertilization and embryo development fail to occur normally in the microgravity environment?

## Science is All About Questions

As you and your students proceed with the CUE-TSIPS activities, you will be progressing through the stages illustrated in the Science Exploration Flowchart (page 20). The following questions are designed to assist you. Remember the power of writing as an assistance to learning. Have your students pose questions and answers, document ideas and diagram relationships.

- 1. What do you observe?**
- 2. What is your question about your observations? What is the question you are exploring?**
- 3. How would you convert the question into an assertion, which is the idea you are experimentally testing (your hypothesis)?**
  - Can you also write this as a *null hypothesis* in which you may state the hypothesis having the opposite, or null, outcome?
- 4. What variable will you change in your tests? What is your treatment? What potential variables will remain constant?**
- 5. What are your control treatments? How will each serve as a control?**
- 6. How many observations for each result are enough? Is  $n = 1$  enough to be representative? If not, what is enough? Why?**



7. **Is there any special experimental design of the treatments and/or replicates needed in the experiment?**



8. **What equipment, tools, etc., will you need for your experiment?**

- Draw your experimental set-up.

9. **What form will your observations take? How will you describe or measure your observations?**



- Use descriptors, comparators, scales and quantitative estimates.

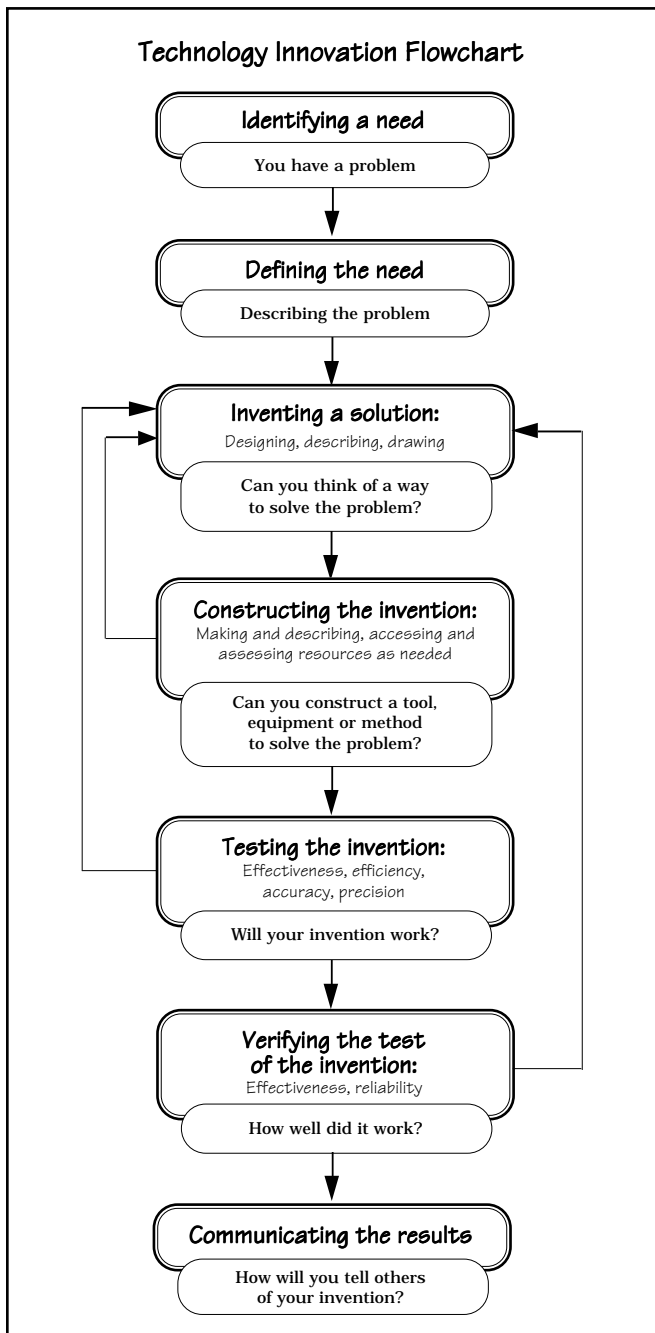

10. **How will you record or tabulate your data?**

11. **How will you organize your data? How will you display your data?**

- Use statistical summarization.

12. **What is your conclusion relative to your hypothesis? What further conclusions can you draw from your analysis of your experiment?**

13. **What other questions come to your mind as the result of this experiment?**

14. **What is the next experiment that you plan to run? Why?**



**The Science-Technology Partnership**  
As students design and execute experiments the need for technological assistance from tools and equipment is ever-present, from the moment of the first observation to the time when new insight is shared with someone across the ocean or across the classroom. Technological innovation, like science, follows a logical progression, resulting in a successful invention and its application to a need or problem.

## Design of the Experiment – Testing the Hypothesis

The heart of science activities lies in the design and execution of the experiment developed to test a hypothesis. It is in this phase of the process of science that technology plays an essential role. To conduct any experiments, technological requirements will arise and will need to be addressed. If the question and hypothesis have been carefully thought out and refined to be experimentally testable, then the design and execution of the experimental phases should yield satisfactory results. As you plan your experimental design, consider the following:

- Keep focused on the question and hypothesis.
- Think of the simplest way, both in the design and in the equipment needed, to run the experiment.
- Alter one variable (treatment) with each experiment and analyze the results.
- Always run control treatments for each experimental treatment such that for each variable in the experimental treatment there is an adequate basis for interpreting the information from the treatment.
- The careful choice and execution of the control treatments is as important in the experiment as that of the experimental treatments.
- Information from the control treatments serves as the basis for determining whether information from the experimental variables is valid and, thus guides the researcher in conclusions as to the validity of the hypothesis.

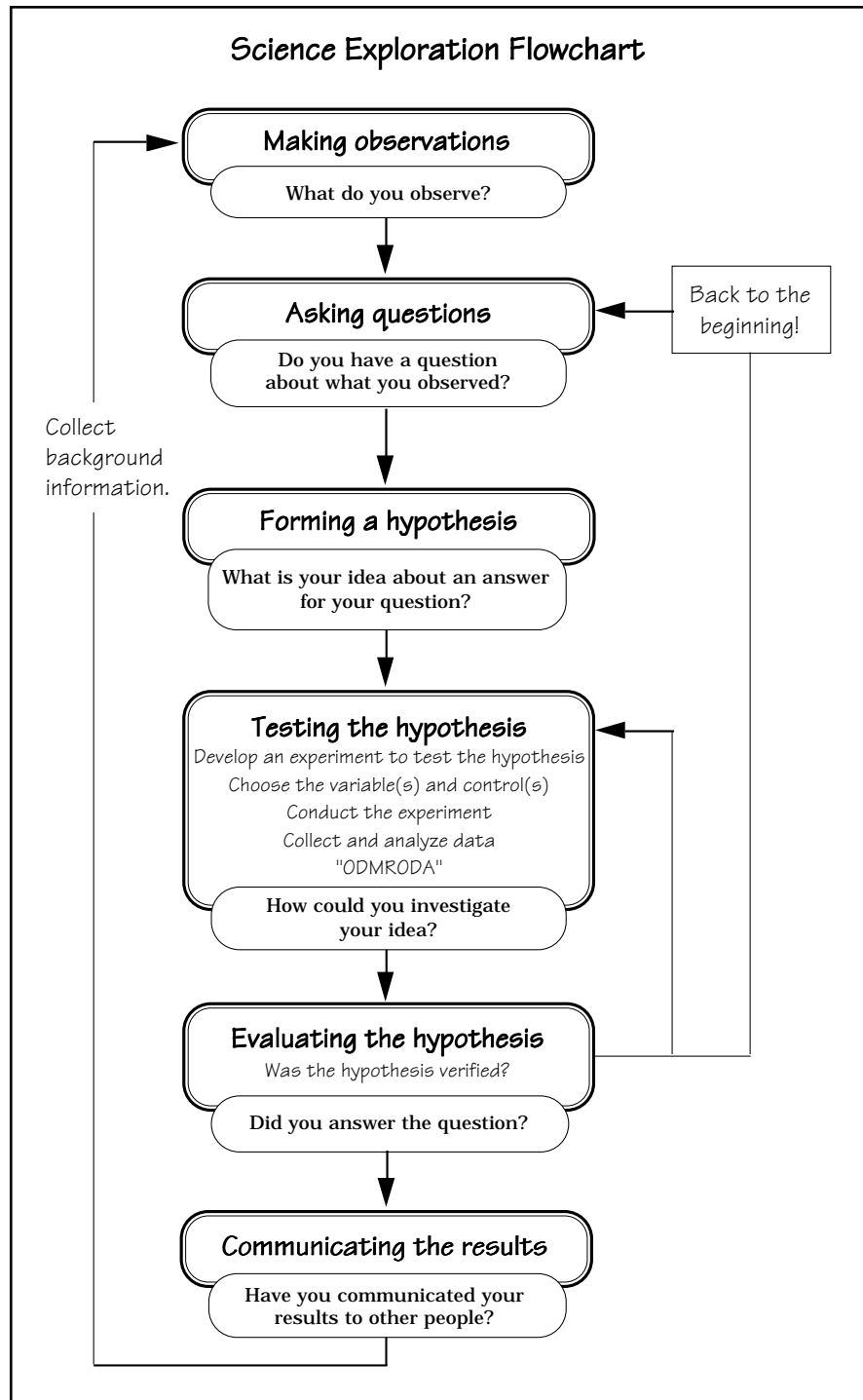



## Execution of the Experimental Investigation

Below are some of the activities involved in the experimental investigation of an hypothesis. For your investigations, use "ODMRODA":

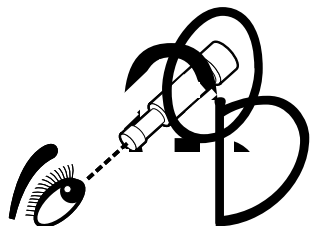

### Observe and Describe:

Using your eyes and other tools to assist in observation (lenses, microscopes, etc.) together with insight from your brain, observe various phenomena or characteristics associated with the experiment and determine the way that you will describe them.

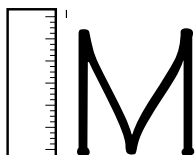

### Measure and Record:

Using tools and devices (eyes, brain, rulers, scales, comparators and experience), measure (quantify) and record numeric and descriptive characteristics as *data*. Estimate, count or compare what you observe while adhering to an understanding of the precepts of *accuracy* and *precision*.

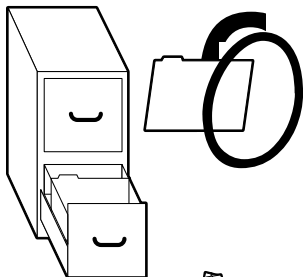
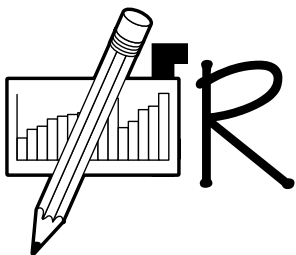

### Organize and Display:

Organize and display recorded data in various ways (tables, charts, graphs, diagrams, drawing, photographs, videos, audios, multimedia, etc.) that will provide insight into phenomena associated with the experiment.

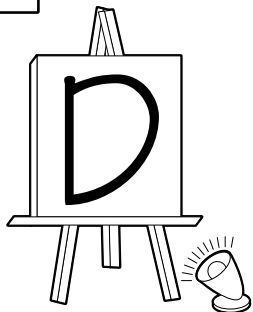

### Analyze:

Observe the data displays (tables, graphs, etc.) for comparisons among treatments, including controls. Apply statistical analysis to the data that provides information from which to derive and develop inferential insight that will be useful in the evaluation of the hypothesis.

## Observing and Describing

Observation is frequently assisted by tools such as lenses, microscopes and other devices that amplify what we see, hear or detect chemically. In living organisms, characteristics which are observed constitute the *phenotype*. Phenotype is the genetically and environmentally determined appearance of an organism. Variation in the phenotype among individuals of the same grouping is a fundamental attribute of life.

In order to be useful in an experiment the phenotype must be described using terms that are widely understood and easily communicated. For these reasons scientists have agreed upon various standards or *descriptors* to describe characteristics in the natural world. Descriptors take many forms (Table 1). The choice of how to describe what you observe is important, because it will determine the kinds of descriptors used and establish the basis for recording, analyzing and communicating results.

Table 1: Examples of descriptors.

Descriptors	Method of description	Examples
<b>number</b>	<ol style="list-style-type: none"> <li>1. direct count</li> <li>2. comparator scale</li> </ol>	<ol style="list-style-type: none"> <li>1. hair on margin of first leaf</li> <li>2. very hairy = 8-9 on a scale of 0 = no hair to 9 = very many hairs</li> </ol>
<b>size</b>	<ol style="list-style-type: none"> <li>1. use of a tool to measure (estimate dimension), e.g. ruler, calipers</li> <li>2. comparator scale</li> </ol>	<ol style="list-style-type: none"> <li>1. height of a plant in mm</li> <li>2. short, medium, tall compared to a range of measure</li> </ol>
<b>color</b>	<ol style="list-style-type: none"> <li>1. visual comparison using standard color chart or scales</li> <li>2. describe with words using hue, lightness and saturation</li> </ol>	<ol style="list-style-type: none"> <li>1. no purple (anthocyanin) color in plant</li> <li>2. very light yellow-green leaves</li> </ol>
<b>shape</b>	<ol style="list-style-type: none"> <li>1. descriptive language (often Latin)</li> <li>2. comparator charts</li> </ol>	<ol style="list-style-type: none"> <li>1. leaf margin lobed edge</li> <li>2. leaf spoon-shaped</li> </ol>

## Measuring and Recording

### Size, Scale and Magnification: "Compared to What?"

It is at the time of observing that students will understand the notions of size, scale and magnification. Some of the CUE-TSIPS activities require that students become familiar with observing, drawing *to scale* and measuring under magnification. To help them view specimens and understand the magnification, *dissection strips* and *dissection cards* have been developed as tools for use in the CUE-TSIPS activities.

## Making and Using Dissection Strips

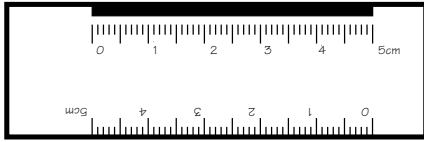

Dissection strips can be made by copying the black line master (page 100) onto a transparency sheet. The copied transparency sheet can be stuck, printed side down, to a "do it yourself" laminating sheet or piece of clear contact paper, and then the individual strips can be cut out. Using the laminating sheet or contact paper as a sealer protects the printing from being pulled off during use of the strip, so strips can be reused.

Once the strips are finished, they are ready for use. Begin by cutting a piece of clear 2 cm adhesive tape to be about 3 cm long. Fold over about 0.75 cm of this piece of tape to make a tab. Stick this tabbed piece of tape to the dissection strip, with the tab at the end of the strip.

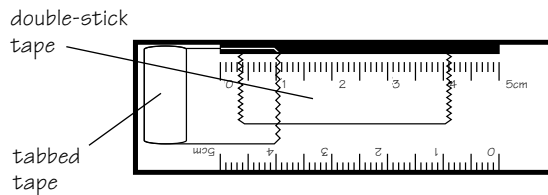
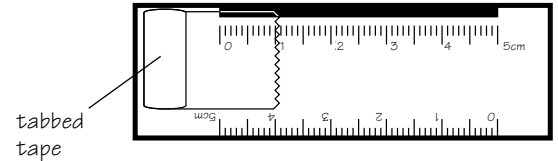

Cut a piece of clear double-stick tape. Place this piece near the top edge of the dissection strip so that the end of the piece overlaps the tabbed piece of tape by a few millimeters.

Specimens for dissection are placed on the double-stick tape. Once your specimen is in place, the specimen and strip can be placed under a dissecting microscope or a film can magnifier (page 97) to make observations.

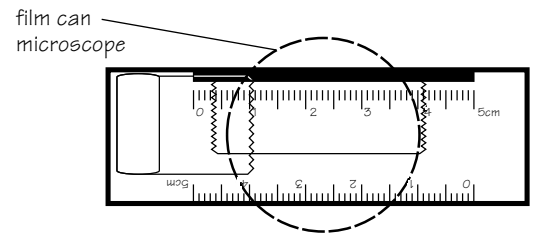

On the dissection card (page 99) are spaces for measuring and recording observations. Each card has two circular fields for sketching what is observed in the field of view delineated by the microscope or film can magnifier.

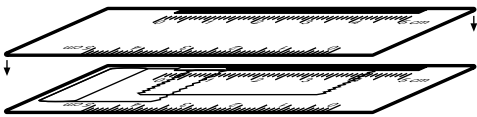

Once a dissection has been completed, the dissected specimen may be taped in a student notebook or removed from the strip by pulling up on the tabbed piece of tape. As this piece of tape is removed it will pull off the used double-stick tape and the strip will be ready for a new dissection. Alternatively, a second dissection strip may be placed over the first to preserve your specimen.

Much of the emphasis in the supplemental activity "Getting Acquainted with a Seed" (page 67) is designed to familiarize students with the use of lenses and scales. As they draw and measure what they observe under different magnifications, students will begin to understand size relationships. Drawing to scale requires practice and sharpens students' hand-eye coordination and sense of perspective and scale. This understanding will be useful to them as they undertake more detailed dissection of AstroPlants embryos.

## Dealing with Variation: The Nature of Normal

Measurable differences will be found among individuals in a group or population. It is therefore important to know how much variation in a particular phenotype (observable trait) might be expected so that it can be determined whether the variation observed experimentally may be viewed as *normal* for that population. Normal would be defined as that range of potential phenotypes that a population would exhibit in a specified range of environmental conditions.

The species *Brassica rapa*, of which AstroPlants are a specially bred stock, is inherently genetically variable. Within a population of AstroPlants one can observe considerable phenotypic variation in some traits such as plant height or intensity of purple stem color. For this reason, it is important to determine what is a normal range of phenotypes for AstroPlants.

## Organizing and Displaying Data: Graphical Representation

When, for example, the heights of a population of 48 AstroPlants are measured in millimeters at Day 10 and recorded (Table 2), considerable variation can be noted. Height is measured from soil level to shoot apex.

**Table 2:** Height, in mm, of 48 AstroPlants measured at Day 10 (hypothetical data).

33	40	32	59	18	45	73	21
49	52	60	55	33	56	32	52
50	84	54	25	57	45	68	41
43	53	43	76	49	39	36	50
62	27	66	39	41	51	55	41
30	47	72	37	44	35	45	48

### The "Stem and Leaf Table"

Simply listed as a set of 48 numbers, relatively little information can be gained from them other than to note that they are variable. An easy way to begin to organize the numbers is to put them into what is commonly known as a *stem and leaf table* (Table 3).

**Table 3:** AstroPlant height data from Table 2 organized into a stem and leaf table.

tens, "stem"	digits, "leaf"
0	
1	8
2	7, 5, 1
3	3, 0, 2, 9, 7, 3, 9, 5, 2, 6
4	8, 3, 0, 7, 3, 9, 1, 4, 5, 5, 5, 1, 0, 8
5	0, 2, 3, 4, 9, 5, 7, 6, 1, 5, 2, 0
6	2, 0, 6, 8
7	2, 6, 3
8	4
9	

To do this, note that each number is broken into "tens" and "digits." Examine each number, breaking it into its tens and digits, e.g., 48 becomes 4 (tens) and 8 (digits). Make a vertical column "stem" listing from zero to 9 that represents the tens. Then enter the digit from each number in the horizontal row "leaf" corresponding to the appropriate ten or stem position; e.g., 48 is listed as an 8 in row 4 in Table 3. Numbers in the range from 10 to 19 go in the "1" row, while numbers in the range from 20 to 29 go in the "2" row, etc.

Considerable information about the population of 48 plants begins to become apparent from the stem and leaf table. For example, it can be observed that the most plant heights in this data set fit into the "4" stem. The numbers representing the plant heights in the population are a set of size 48 ( $n = 48$ ).

## The Frequency Table

The set of 48 plant heights can be organized into groupings or *classes* representing a specified range of values or *class interval* ( $i$ ). In this example the class interval is 10 mm:  $i = 10$  mm. The number of plants having heights within a particular class interval (e.g., 20 to 29 mm) is the *class frequency* ( $f_i$ ). The *relative frequency* of a class is determined by looking at the number of measurements in a class ( $f_i$ ) relative to the number of measurements in the entire data set ( $n$ ):  $f_i/n$ .

With the above information the set  $n = 48$  can be arranged in a *frequency table* by counting and recording the numbers in each class ( $f_i$ ) and calculating the proportion of numbers in each class to the total set ( $f_i/n$ ). The relative frequency of the class interval 20 to 29 mm in the example set of 48 plant heights is  $f_i/n = 3/48 = 0.06$ .

**Table 4:** Frequency table of heights, in mm, of 48 AstroPlants at Day 10, grouped in classes of 10 mm intervals and relative frequency of each class.

class interval, $i$	0	10	20	30	40	50	60	70	80	90
class frequency, $f_i$	0	1	3	10	14	12	4	3	1	0
relative frequency, $f_i/n$	0	0.02	0.06	0.20	0.29	0.25	0.08	0.06	0.02	0

$n = 48, i = 10$

Note: relative frequency fractions should add up to 1, rounding numbers in this example reduced this to 0.98.

## The Frequency Histogram

The relationship among the numbers in each class can be more effectively visualized by displaying them as a *frequency histogram* in which the data are treated as two variables,  $x$  and  $y$ , and plotted in relation to each other in a two-dimensional graph with the  $x$  and  $y$  axes at  $90^\circ$  to each other.

The first variable, the class interval ( $i$ ), was chosen to be  $i = 10$  is the *independent variable* as it was predetermined by choice. The independent variable is arrayed on the  $x$  or *horizontal axis* just as it appears in the frequency table (Table 4).

The second variable is the class frequency ( $f_i$ ) and is known as the *dependent variable* because the number in the particular class ( $i$ ) depends on the class chosen and is arranged and plotted on the  $y$  or *vertical axis* of the graph. When plotting the  $x$  and  $y$  axes of a graph it is important to consider the size or scale of a unit on each axis so that an effective symmetry is achieved in the presentation of the graph. Figure 1 is a frequency histogram of the data from the frequency table, Table 4.

The relative frequency ( $f_i/n$ ) from the frequency table can also be plotted as a *relative frequency histogram*. In this case the  $x$ -axis remains the same as in the frequency histogram and the  $y$ -axis is arrayed in units of decimal fractions. The appearance of the relative frequency histogram is similar to the frequency histogram, however what is being portrayed is the relative proportion of a class size in relation to the set.

Choosing the proper class interval can be important to the process of analyzing and understanding the information that is codified in the data set of plant height measurements. If the chosen class interval is too small or too large, certain relationships among the individuals within the set will not be evident.

**Figure 1:** Frequency histogram of heights, in mm, of 48 AstroPlants at Day 10, grouped in class intervals of 10 mm.

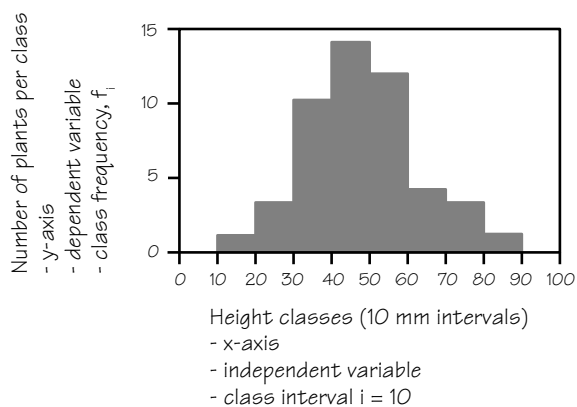

For example if a class interval of  $i = 25$  rather than  $i = 10$  were chosen then the frequency histogram would appear as in Figure 2 or if a class interval of  $i = 2$  were selected the frequency histogram would appear as in Figure 3.

**Figure 3:** Frequency histogram of heights, in mm, of 48 AstroPlants at Day 10, grouped in class intervals of 2 mm.

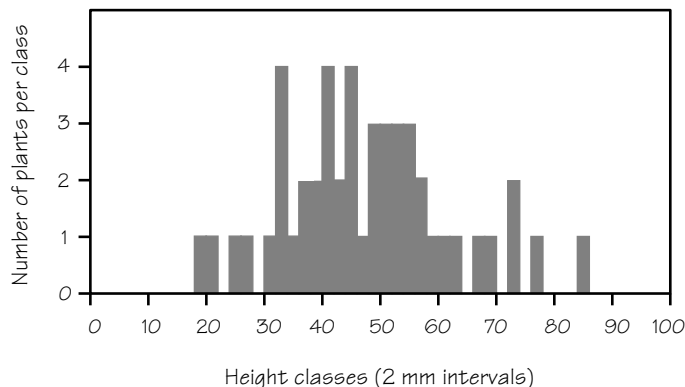

**Figure 2:** Frequency histogram of heights, in mm, of 48 AstroPlants at Day 10, grouped in class intervals of 25 mm.

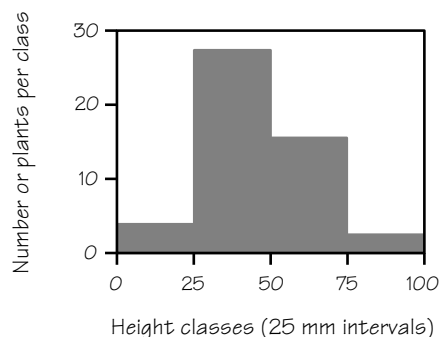

### The Normal Curve

The outline of a frequency histogram roughly depicts a curve known as a *frequency curve*. Frequency curves can assume various different shapes. Interpretation of the shapes can give insight into underlying phenomena conditioning the expression of the phenotype's contribution to the curve. For instance, the data on plant height recorded in the data chart (Table 2), organized in a frequency table (Table 4), and displayed in the frequency histogram (Figure 4) depicts what is referred to as the *normal distribution curve* or the *normal curve*. A *bell-shaped normal distribution* is commonly observed for many phenomena and is the basis for certain kinds of statistical summarization and interpretation.

**Figure 4:** Frequency histogram of heights, in mm, of 48 AstroPlants at Day 10, grouped in class intervals of 10 mm.

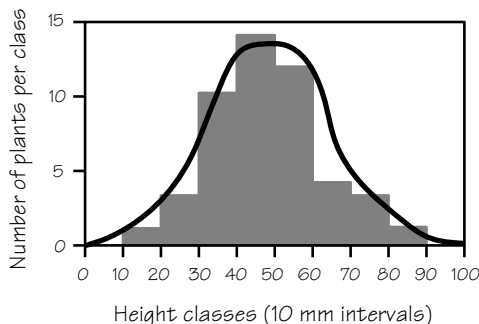

## Organizing and Displaying Data: Numerical Representation

### Range

**r**

There are various ways of describing or summarizing the variation in heights of the 10 day old AstroPlants recorded in Table 2 and displayed in Figure 4. One way is in terms of *range* ( $r$ ). Range extends from the shortest plant to the tallest plant and is defined as: " $r$  = the difference between the largest and smallest numbers in a set of data." Here again the stem and leaf diagram is useful in identifying the range,  $r = 84 - 18 = 66$  mm. The range identifies the upper and lower limits of a data set and is helpful in determining the limits of the x-axis on a graph. When measuring a population of AstroPlants over several days of growth it is interesting to observe what happens to the range of plant heights. Does the range stay the same, decrease or increase? Why?

### Mean, Median and Mode: Measures of Center

Another way to summarize the variation represented in a set is in terms of averages. Continuing with our example, the average or *arithmetic mean* ( $\bar{x}$ ) is the sum of the measurements divided by the total number of measurements,  $n$ :

**X**

$$\bar{x} = \sum_{i=1}^n x_i / n = (x_1 + x_2 + \dots + x_n) / n$$

When phenotypes are distributed normally, the mean can be a useful way of summarizing or representing the set. The mean or average is a way of representing a data set using a single number. In our example the mean is:

$$\bar{x} = (x_1 + x_2 + \dots + x_n) / n = (2212) / (48) = 46.08$$

Another way of identifying a central point in the data set is to identify the *median* ( $md$ ), or middle value of a set. The median is the highest value divided by two, in our example:

**md**

$$md = 84 / 2 = 42$$

Notice that the median differs from the mean by approximately 5 mm ( $46 - 42 = 4$ ).

Yet another way of representing the data set with a single number is to use the *mode* ( $mo$ ). The mode is the measurement with the highest frequency. Again, by scrutinizing each "leaf" of the stem and leaf diagram, you will observe that the number 45 mm appears three times. All others appear less frequently. This would be the mode for our example:

**mo**

$$mo = 45$$

As is characteristic with normally distributed data, the mean, median and mode tend to be in proximity. With some natural phenomena which are not normally distributed there may be more than one mode, hence the terms *bimodal* and *trimodal* (Figure 5). In other distributions the mode may be widely separated from the mean and median (Figure 6).

Figure 5: Example of a bimodal frequency curve.

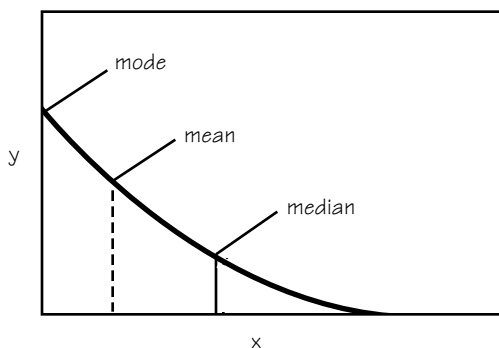
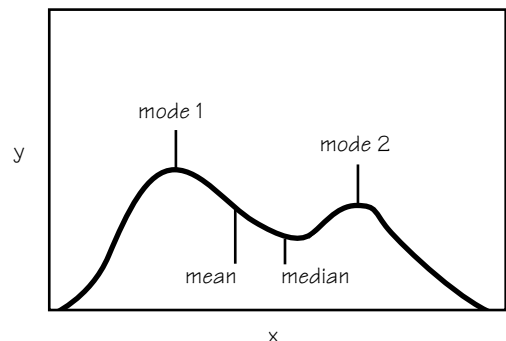

Figure 6: Example of a frequency curve with widely spread mode, mean and median.

## Standard Deviation and Variance

Although the mean is probably the most useful value in representing a set of measurements, the mean does not give an indication of the way in which the values of the set are distributed around the mean. In other words, how the shape of the bell in the normal frequency curve appears. The *standard deviation* ( $s$ ) is a statistical notation that provides an indication of whether the measures of phenotype are widely distributed around the mean. When  $s$  is relatively high the normal curve is broad; when  $s$  is low the curve is relatively narrow, or tightly distributed around the mean (Figure 7).

The standard deviation is the square root of the *variance* ( $s^2$ ), which is the sum of the squared deviations of each value from the mean  $\bar{x}$  divided by  $n-1$ , the set size minus one.

$$s^2 = \frac{\sum (x_i - \bar{x})^2}{n-1}$$

S

Though the standard deviation is a tedious calculation to make with a pencil and paper, most hand calculators with a statistical capability will have functions that automatically provide the mean ( $\bar{x}$ ), variance ( $s^2$ ) and standard deviation ( $s$ ).

**Figure 7:** Example of normally distributed frequency curves depicting high A and low B standard deviations.

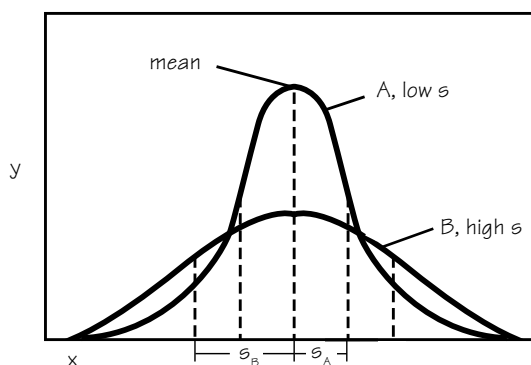

## Statistical Summaries

For our data set of 48 height measures of 10 day old AstroPlants, the summarized statistical data are given in Table 5.

From the statistical summaries and graphical displays of the data sets you and your students will be able to better understand the variation that will become evident in all aspects of the CUE-TSIPS investigations. Throughout, the activities of measuring and recording, organizing and displaying are important. In order to communicate your observations, results and conclusions effectively with others, it is important that you compare the same sorts of data in the same terms of reference. The CUE-TSIPS activities have been designed so that your students will be able to share their data with others and generate discussion of their results.

**Table 5:** Statistical summary of height data of 48 AstroPlants from Table 2.

number in set	$n = 48$
range	$r = 66 \text{ mm}$
mean	$\bar{x} = 47.13 \text{ mm}$
standard deviation	$s = 14.27 \text{ mm}$

## Data Sheets and Tables

Data sheets or tables need to be organized so as to receive descriptive information in a logical and orderly manner that will minimize the likelihood of entry errors and that will aid in later summarization and analysis. For each activity, examples of student and class data sheets have been provided. With most of the experiments, the data sheets also contain columns for data summation and statistical analyses. Calculators with graphical capabilities may be useful to students in analyzing data.



# CUE-TSIPS Mission Calendar

The CUE-TSIPS Mission Calendar is arranged to follow along with the timing of the experiments being performed on the CUE Space Shuttle mission in October, 1997. To establish the "real-time" schedule, count back from the day of launch, once scheduled and confirmed by NASA, to find the start date.

## Teacher Preparation

Time	Activity
May to August, 1997	<ul style="list-style-type: none"> <li>- construct or order light bank (get supplies for light bank from hardware store)</li> <li>- purchase AstroPlants seeds (page 94)</li> <li>- purchase peatlite root medium (page 94)</li> <li>- purchase salts for Wisconsin Fast Plants Nutrient Solution or commercial fertilizer (page 94)</li> </ul>
August to September, 1997	<ul style="list-style-type: none"> <li>- assemble materials for the student Plant Growth Chambers (page 32)</li> <li>- purchase other recommended supplies, including a hi-low thermometer (page 14) and pest control cards (page 17)</li> </ul>



"Day" refers to the ordered timing of activities. In the "Day" column, "T" stands for "terminal," a term used by NASA to indicate time of launch. The abbreviation "das" stands for "days after sowing." The abbreviation "dap" stands for "days after pollination."

Beginning with Day 14, each activity is given a span of days rather than a specific day. The timing of these activities depends on the rate of growth and development of your plants, depending specifically on the day that your students pollinate. For these activities, follow the "dap" designation, performing each at the appropriate number of days after pollination.





Remember that the bean icon indicates that an activity can be completed with seeds from plant types other than AstroPlants. These activities are part of the supplemental sections and do not need to be performed as part of the central CUE-TSIPS experiments.



## Countdown to Launch

Day	das	dap	Subject Areas	Activity
T minus 4-2 weeks	-	-	- construct the life support system (light bank)	
T minus 10 days	-	-	- prelude to planting	 - "Getting Acquainted with a Seed" (page 67)
T minus 7-5 days	-	-	- germination	 - Germination activity: "Launching the Seed" (page 74)
T minus 5-1 days	-	-	- constructing the PGC	- students make and assemble the Plant Growth Chambers (page 35)

## Launching the Seed

Day	das	dap	Subject Areas	Activity
Day 0	0	-	- planting	- sow seed, place complete PGCs under lights (page 35)
Day 1	1	-	- orientation, tropism	 - tropism activity: "How do Plants Know Which Way to Grow" (page 79)
Day 2	2	-	- orientation, tropism	 - tropism activity: "Do Plants Prefer the Blues?" (page 86)

## Life in Orbit

Day	das	dap	Subject Areas	Activity
Day 3	3	-	- growth, development	- each student notes number of emerged plants, records number on AstroPlants Growth Group Data Sheet (page 41)  - revisit gravitropism chamber
Day 5	5	-	- orientation, tropism	 - revisit gravitropism chamber - revisit phototropism chamber
Day 7	7	-	- growth, development	- thin to two plants per film can wick pot - each student measures plant height, records data on AstroPlants Growth Group Data Sheet
Day 11	11	-	- growth, development	- each student measures plant height, records data on AstroPlants Growth Group Data Sheet
Day 12	12	-	- pollination	- make beesticks (page 46)
Day 14	14	-	- growth, development	- each student measures plant height, records data on AstroPlants Growth Group Data Sheet

## Reproduction in Orbit

Day	das	dap	Subject Areas	Activity
Day 14-16	14-16	0	- growth, development - pollination	- each student notes day of first open flower, records day on AstroPlants Growth Group Data Sheet - each student removes the most apical (top) flower on two plants, makes floral strip, measures and records pistil length on Floral Clock Student Data Sheet (page 51), numbers open flowers - each student pollinates all open flowers, terminalize plants (pinch off all but open flowers 1-4) - record stigma position in flowers 1-4 on Floral Clock Student Data Sheet

## Reproduction in Orbit, continued

Day	das	dap	Subject Areas	Activity
Day 17-20	17-20	3	- growth, development	- each student measures pistil length on flowers 1-4, records data on Floral Clock Student Data Sheet
Day 21-22	21-22	6	- double fertilization, embryogenesis	- each student measures pistil length on flowers 1-4, records data on Floral Clock Student Data Sheet - AstroPlants embryo dissection, record data on Ovule and Embryo Student Data Sheet (page 65)
Day 23-24	23-24	9	- double fertilization, embryogenesis	- each student measures pistil length on flowers 1-4, records data on Floral Clock Student Data Sheet - AstroPlants embryo dissection, record data on Ovule and Embryo Student Data Sheet
Day 26-28	26-28	12	- double fertilization, embryogenesis	- each student measures pistil length on flowers 1-4, records data on Floral Clock Student Data Sheet - AstroPlants embryo dissection, record data on Ovule and Embryo Student Data Sheet
Day 35-37	35-37	21	- double fertilization, embryogenesis	- each student measures pistil length on flowers 1-4, records data on Floral Clock Student Data Sheet - AstroPlants embryo dissection, record data on Ovule and Embryo Student Data Sheet - remove plants from water
Day 43-45	43-45	28		- harvest seeds - test seed for viability in bottle cap seed germinator (page 75)

# Getting Started

Engineering of life support systems in space flight involves designing, building and operating the equipment that creates, monitors and regulates those components of the environment that are essential for normal plant growth.

To participate in the CUE-TSIPS activities, you and your students will create a growing environment for the plants. In groups of four, students will construct Plant Growth Chambers (PGCs) and start the life cycle of their AstroPlants in Activities One and Two.

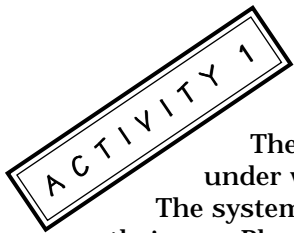

## Constructing the PGC

### Introduction

The CUE-TSIPS growing system has been designed to simulate the conditions under which plants will be grown pre-flight and in-flight on the Space Shuttle mission. The system uses readily available, low-cost materials with which students can construct their own Plant Growth Chambers.

Each group of students will need one PGC for experimental plants. Control plants will be grown separately in additional PGCs. For pollination and fertilization activities, **each class will need at least 16 extra plants (two PGCs) to serve as controls.**

### Time Frame

Teachers may choose to have their students construct PGCs prior to the start of the CUE-TSIPS activities or use the "CUE-TSIPS Mission Calendar" to time the construction with the Shuttle mission.

Working in groups of four, construction of the PGC components (lid and base) would take about one 50 minute class period. Assembly of the components once students are ready to plant will take about 15 minutes.

### Learning Objectives

This activity is largely technology-based. In participating in this activity students will:

- learn to construct experimental equipment; and
- make accurate measurements.

## I. PGC Lid Construction

### Materials

- transparent acrylic sheet, 2 mm (1/8") thick (comes in various dimensions, illustrated as a sheet 70 cm x 80 cm), or other clear plastic sheets (e.g., report covers, overhead transparencies, etc.)
- cutter for acrylic sheet (such as Red Devil®) and/or scissors for plastic sheets
- 2 cm wide clear adhesive tape
- fine tipped permanent marker
- metal or wood file, or sand paper

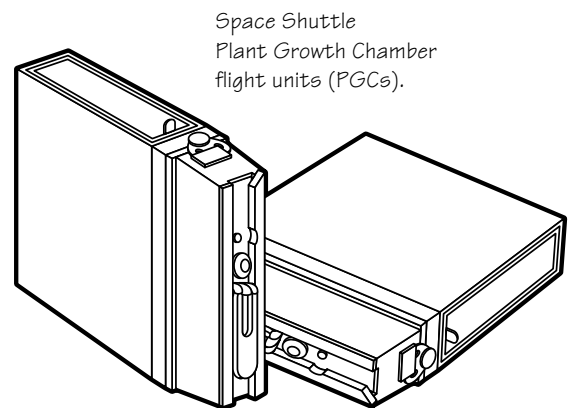

## Procedure

1. Use a marker to mark the cut lines on the acrylic sheet as shown. For other types of clear plastic make appropriate measures and cuts.

Each PGC lid includes pieces in the following dimensions:

- two pieces 20 cm x 21.5 cm (front and back panels), and
- two pieces 20 cm x 5.6 cm (side panels).

A 70 cm x 80 cm acrylic sheet can be cut as shown at right to yield pieces for four PGC lids.

2. Cut the acrylic sheet with the cutter (or with a circular table saw with a hardened blade). Peel off the protective plastic film.

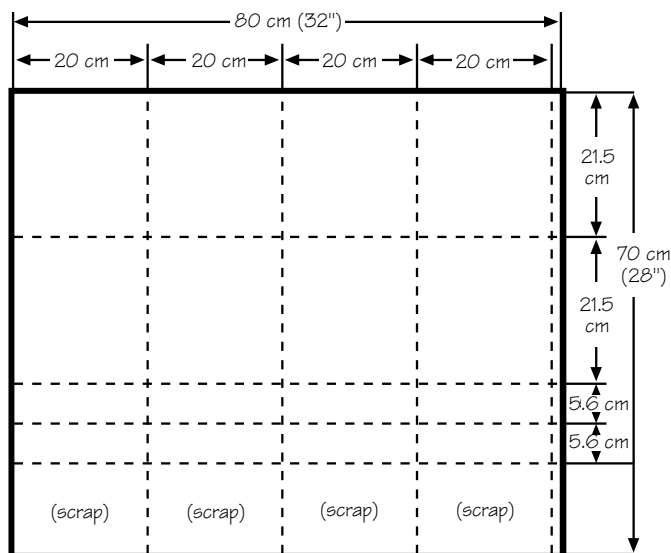

**Caution:** Acrylic sheet cutters and saws are very sharp and should be used with care.

### Tips:

- Smooth off sharp edges of the cut acrylic pieces using a file or sand paper.
  - For thin plastic sheets, cut the front panel to be shorter to access plants.
3. Assemble the PGC lid as follows:
    - Use two pieces of clear adhesive tape to attach the back panel to one of the side panels. Place one piece of tape about 2 cm from the top and one about 4 cm above the bottom edge on each side-back joint.
    - Use two pieces of tape to attach a side panel to the other side of the back panel. Again, place one piece about 2 cm from the top and the other about 4 cm above the bottom edge. Three of the four panels should be taped together at this point.

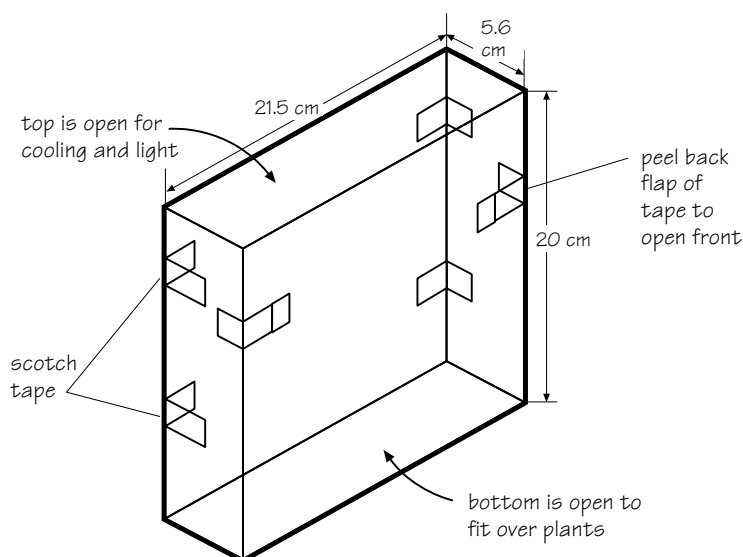

- Tear off two additional pieces of tape. On each piece, fold over one end about 1 cm to make a flap. Place one of these two pieces of tape on each side of the front panel, with the flap end on the front panel. By peeling back these pieces, the front panel can be removed and replaced, allowing easy student access to the plants inside the PGC.
- If using thin plastic sheets, support them by taping panels to bamboo grilling skewers at the corners. The skewers can be poked into the styrofoam film can wick pot holder (page 35).

## II. PGC Base Construction

The basic growing system utilizes peatlite (peat moss:vermiculite, 1:1) as the root medium, and a capillary wicking system to provide water and nutrients to the plants in film can wick pots. Although the peatlite medium and film can wick pot system is not being used in the Space Shuttle Plant Growth Chambers, it is recommended as the most reliable system in which AstroPlants can be grown.

### Materials

- two plastic drawer organizers (22 x 7.6 x 5.1 cm), the first to be a base which will hold the film can wick pots and the second to act as a reservoir
- four 35 mm black film cans for wick pots
- capillary wicking material
- styrofoam block (2.5 cm thick, 21 cm long x 5.5 cm wide), cut from builder's insulating foam

### Procedure

1. Melt or drill an approximately 5 mm diameter hole in the center of the bottom of each film can.

**Caution:** Melting plastic produces noxious fumes; perform this step in a well-ventilated area. Wear safety goggles if using a drill.

2. From the capillary wicking material, cut four diamond wicks (3 cm x 1 cm), with tapered ends, for the film can wick pots.

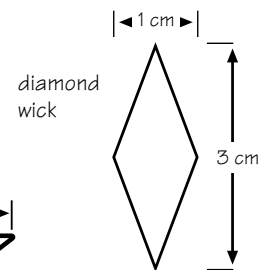

3. From the capillary wicking material, cut a wick strip to be 30 cm long and 1 cm wide, with tapered ends.

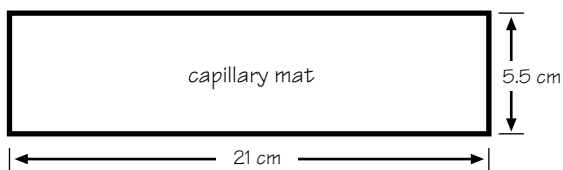
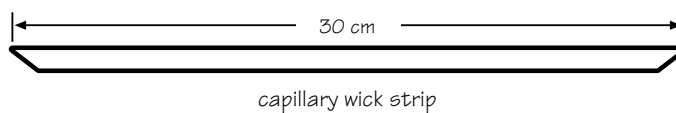

4. From the capillary wicking material, cut a capillary mat to fit the bottom of one of the drawer organizers (21 cm x 5.5 cm).

5. With a hot soldering iron or large hot nail melt two 2 cm slots in the bottom of one of the drawer organizers to accommodate the capillary wick; this organizer will become the base for the growing system.

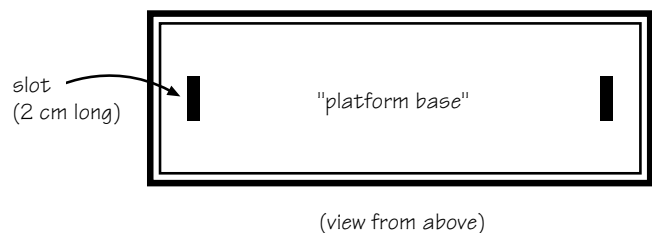

**Caution:** Melting plastic produces noxious fumes; perform this step in a well-ventilated area.

6. From 2.5 cm (1 inch) thick insulating styrofoam, measure and cut, with a fine blade saw (hacksaw or utility saw), a rectangular block 21 cm long by 5.5 cm wide. Rough edges where the styrofoam is cut may be smoothed with sandpaper.

7. With a pen and a film can, trace four equally spaced circles on the top surface of the styrofoam block (this block will hold the film can wick pots).
8. Using a 33 mm (1.25 inch) circular "keyhole" cutter in an electric drill, cut four holes equally spaced in the styrofoam block. Alternatively the hot flamed rim of a Pyrex® test tube (18 to 22 mm diameter) may be used to melt the four holes. Other forms of film can wick pot holders, such as wooden blocks, are satisfactory.

**Caution:** Melting styrofoam produces noxious fumes; perform this step in a well-ventilated area. Wear safety goggles if using a drill.

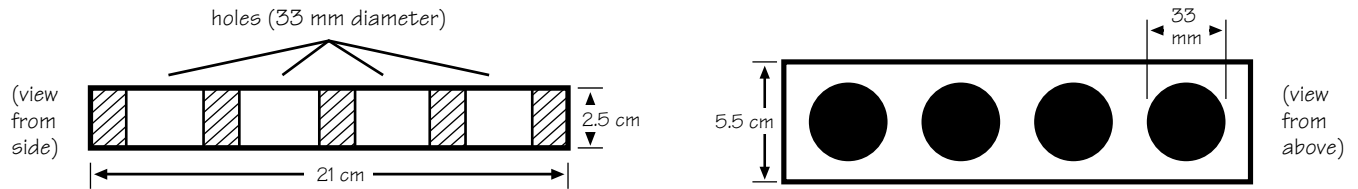

## Planting AstroPlants in the PGC

### Introduction

After constructing the PGC lid and base, students are ready to begin planting. Planting can be timed with the flight experiments by following the "CUE-TSIPS Mission Calendar" (page 29). Once seeds have been planted, the AstroPlants life cycle is underway.

### Time Frame

With an assembled PGC (lid and base), planting and placing the completed PGCs under lights will take less than one 50 minute class period.

### Learning Objectives

In participating in this activity students will:

- understand the importance of capillarity in providing a continuous supply of water and nutrients to the plants (see "Water," in "Understanding the Environment," page 15);
- learn the importance of the physical characteristics of the peatlite root medium in providing a suitable environment for normal root growth and function; and
- understand the role of water in activating the process of seed germination.

"Though I do not believe that a plant will spring up where no seed has been, I have great faith in a seed. Convince me that you have a seed there, and I am prepared to expect wonders."

- Henry David Thoreau,  
*The Dispersion of Seeds*, 1860

### Materials

- PGC lid and base, reservoir, film can wick pots and capillary wicks and mat (from Activity 1)
- 16 AstroPlants seeds
- forceps for handling seed
- peatlite root medium and horticultural vermiculite
- nutrient solution, such as Wisconsin Fast Plants Nutrient Solution or commercially available fertilizer (page 96)
- white lab tape

## Procedure

1. Collect and assemble the components of the PGC lid and base along with the other materials required for this activity. Each group of three to four students should plant in one PGC. Additional PGCs for control plants can be planted by volunteers or the teacher.
2. On **Day 0**, wet the four diamond wicks and insert one saturated diamond halfway through the hole in the bottom of each film can. The emerging ends of the wicks will make contact with the capillary mat.
3. Wet the long capillary wick and mat. Feed the wick through the slots in the base platform so that a length of 5 cm is emerging from each slot, hanging below the base. Place the wet capillary mat over the wick in the bottom of the tray, make sure there are no air pockets trapped in the mat.
4. Fill each film can wick pot with slightly moistened peatlite, to the rim, tapping lightly to settle the peatlite. Remove the excess peatlite above the pot rim. **Do not** press down on the peatlite. Carefully moisten the peatlite by watering from above until the wick drips. The peatlite will settle slightly to a few millimeters below the rim of the can.
5. Place four seeds in the form of a cross at the rim of the pot. Cover the seeds to the film can rim with horticultural vermiculite and gently water again from above.
6. On a piece of white lab tape placed just below the rim, label each film can with a student number (1 to 4). Carefully place each film can into its hole in the styrofoam holder. Place the styrofoam and film cans into the base platform drawer organizer, on top of the wet capillary mat.

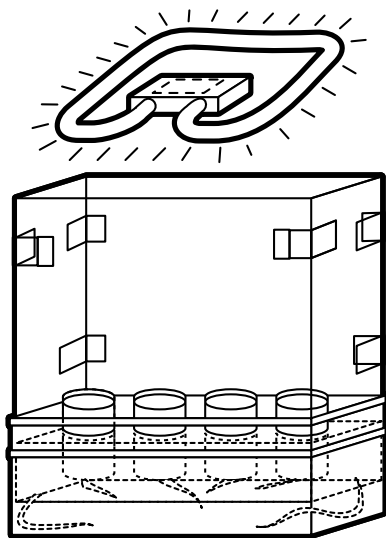
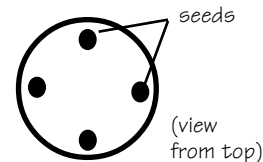

7. Add about 2 cm depth, approximately 200 ml, of Wisconsin Fast Plants Nutrient Solution to the second drawer organizer (without slots), to act as the reservoir.

If a commercial liquid fertilizer is used (e.g., Peters® 20-20-20), fill the reservoir with a 2 cm depth of water. Add fertilizer solution at the soil surface at the rate of 4 ml per film can wick pot on **Days 3, 7, 14, 21 and 28** (page 16). Do not put the fertilizer solution in the water reservoir.

8. Place the base platform drawer organizer into the second reservoir drawer organizer, with the wicks beneath it. The water or nutrient solution will be carried via capillary action into the film can wick pots and to the plants.
9. Carefully place the assembled lid of the PGC into the base platform, with the walls outside of the foam. Label each PGC appropriately (date and time of sowing, seed stock, student names, student group number, etc.).
10. Place the PGC with film can wick pots under lights.

**Note:** The time that the seeds are moistened begins the timing of the growth cycle. From this point on time is taken as days after sowing or "das."



# Growth, Development and Flowering

## Concepts

Growth represents increase in size, number and complexity of plant cells and organs. Both environment and genetics play fundamental roles in regulating growth. The energy for growth in plants comes from photosynthesis and respiration. Variation within a population is related to variation in both the genetic constitution and the growth environment of the individuals.

## Questions

- What is the role of the environment in regulating plant growth?
- How do plants grow?
- How does a plant know when to produce leaves and when to produce flowers?

## Background

The environment is created by the interaction of physical (light, temperature, gravity), chemical (water, air, minerals) and biological components (microbes, larger organisms). When environmental conditions are favorable, plant growth occurs. Following the emergence of the germinating seedling from the soil, growth of the plant continues through developmental stages in which new plant parts – leaves, stem and flowers – are produced from the growing point known as the *shoot apical meristem*. Further growth is observed as the increase in size of the new leaves, stems and flowers.

In AstroPlants, growth is most dramatic in the 10 to 12 days between seedling emergence and the opening of the first flowers. During this period, students may explore important concepts that will help them understand growth and development.

Each part of the plant performs important functions in the life cycle. The *roots* anchor the plant in the soil so that it doesn't wash or blow away. The roots also provide the means by which plants obtain water and minerals from the soil. The *stem* supports leaves and flowers and ensures that these parts are in the best position to perform their special tasks. The stem also transports water and minerals from the roots, and food manufactured in the leaves, to other plant parts.

The *leaves* are positioned to capture sunlight. In the process of photosynthesis, energy from sunlight is trapped by the green chlorophyll in leaves. This energy is used to manufacture food [carbohydrates (CHO)] by combining the carbon (C) and oxygen (O) from carbon dioxide (CO<sub>2</sub>) in the air with hydrogen (H) which is transported from the roots as water (H<sub>2</sub>O).

*Flowers* contain many specialized parts that are formed to ensure that the seed of the next generation of plants will be produced and then dispersed to new locations for growth (Raven, Evert and Eichorn, 1992).

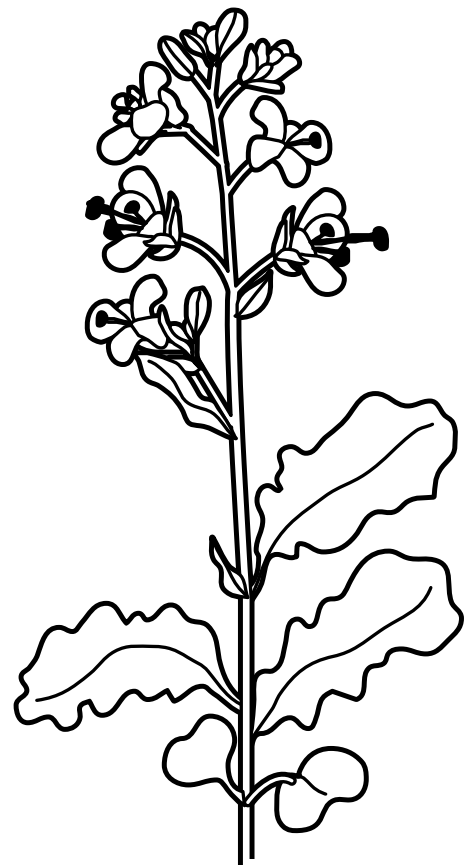



# Tracking Variation within the Normal Growth and Development of a Population of AstroPlants

## Introduction

With four students working as a team with one PGC, each student will be responsible for two plants in a subpopulation of eight. Students will sow four seeds in each film can wick pot and place them in an environment conducive to germination, growth and emergence. After plants emerge students will select two of the four plants and track their growth and development by measuring plant height at specified days after sowing (das).

Data collected by students on their plants will become part of a class data set, which will be organized, summarized, analyzed, plotted and displayed so that students may gain a better understanding of the normal variation within a population of AstroPlants as they grow and develop.

**Question:** How much variation is exhibited within and among subpopulations of AstroPlants grown under standard environments in classrooms across the United States and Ukraine?

**Sample Hypothesis:** A normal amount of variation will exist.

## Design

- Subpopulations of AstroPlants are grown in classroom PGCs, specified growth parameters (height, etc.) are measured and summarized results compared with other subpopulations and with experimental subpopulations grown in microgravity on the Space Shuttle orbiter.
- Students will record data on their AstroPlants Growth Group Data Sheet (page 41).
- It is important for each class to have at least 2 sets of 4 film can wick pots in extra PGCs to serve later as unpollinated control plants. Plant and maintain the extra PGCs in the same manner as the experimental PGCs, being careful to avoid pollen transfer once the control plants are in flower.

## Time Frame

A period of 16 days from the sowing of seed is required for the growth of the AstroPlants and the completion of the activity. Class time required daily will vary depending on the developmental stage of the plants and the activity.

## Learning Objectives

In participating in this activity students will:

- learn about plant growth by observing the emergence of seedlings, observing and measuring increases in plant size and in number, size and complexity of plant parts;
- understand the role of environment in regulating plant growth;
- observe, measure and analyze variation in growth and development among individuals in a population of plants;
- consider the use of statistical and graphical representation of growth and development within a population; and
- understand that growth in plants represents an ordered sequence of developmental events which vary between individuals of a population within limits that are defined as "normal" (see page 26).

## Materials

- white lab tape
- metric ruler
- black fine-tipped marking pen
- PGC with seeded film can wick pots, three days after sowing (Day 3)

## Procedure

1. On **Day 0**, students planted AstroPlants and placed the experimental and control PGCs under recommended lights (Activity 2, page 35).
2. By **Day 3**, seedlings will have emerged. At the time of sowing, film cans were numbered for students 1 to 4. Refer to the AstroPlants Growth Group Data Sheet and record the number of seedlings that have emerged from each film can wick pot.
3. On **Day 7**, thin the plants in each film can wick pot by carefully snipping off two of four plants at soil level with fine scissors. Number the remaining two plants on the white tape label of each pot. Each team of four students should have plants numbered from 1 to 8 according to the AstroPlants Growth Group Data Sheet.
4. On **Day 7**, each student should measure the height of his/her two plants (in millimeters) and record the measurements on the group's AstroPlants Growth Group Data Sheet.

**Note:** Measure height from the soil to the apex as indicated in the illustration, not to the highest part of the leaf.

At this time students will have generated a group data set. Teachers may wish to have students practice some simple organization and analysis activities on the group data and have students enter data into a class population data set.

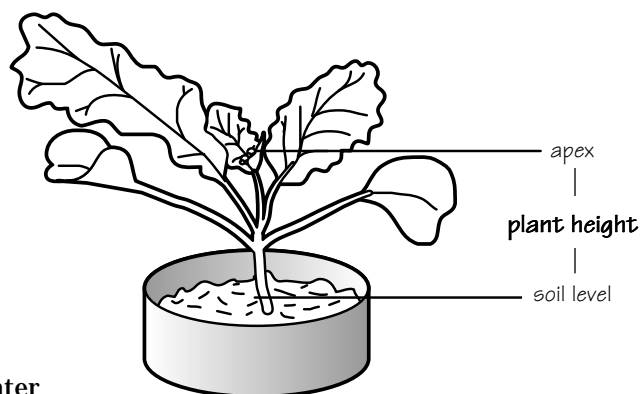

5. Continue to observe the developing plants. As the plants grow, they will draw increasingly more liquid from the system; be sure to check reservoirs daily and fill as needed.

Around **Day 9** students will notice the first appearance of small flower buds in the apex of the growing shoot. Within these buds the tissues that lead to the production of the male and female sex cells are differentiating.

Over the next six days the buds will enlarge as male gametes develop within the anthers and as female gametes develop within the ovules of the pistil (page 43).

6. On **Day 11**, each student should again measure and record the height of his/her two plants. Notice that the plants are beginning to elongate more rapidly. All of the leaves on the main stem have formed and flower buds are more prominent.
7. Sometime between **Day 12** and **Day 14**, flowers on individual plants will begin to open. For each plant, record the number of days after sowing (das) when the first flower opens.
8. A final measurement of height should be made on **Day 14**, even if some plants are not in flower. After all of the students' data are in and recorded, it is a good time to observe and discuss the variation within plant population growth over time.
9. Following **Day 14**, many of the flowers will be opening on the plants, awaiting pollination. The pollination activity (Activity 4, page 46), should be carried out on **Day 15** or **Day 16**, or when most plants have been in flower for two days. The timing of pollination may vary depending on the environment in which the plants have been growing.

### *Concluding Activities and Questions*

Combine the group data into a class data summary using the AstroPlants Growth Class Data Sheet (page 42). See "CUE-TSIPS Science and Technology" for a review of data analysis (page 18).

If available, use data analysis software to create graphical and statistical summaries of class data. Notice how the various statistical notations (range, mean and standard deviation) change over time from sowing. Have students consider the following:

- From a class frequency histogram and statistical summary, does the measured plant character of height exhibit a normal distribution within the class population as hypothesized?
- Are their individual plants shorter than the average in the population? Or taller?
- Do their individual plant heights fall within one or two standard deviations of the class mean? Would they consider their plant heights to be normal? Why or why not?
- How many plants in the population fall within one or two standard deviations of the class mean?
- Are there any "abnormal" plants?
- There are many other ways that students could measure growth and development. Height is only one. Can they come up with others?

Classes can submit the AstroPlants Growth Class Data Sheet to the Wisconsin Fast Plants Program and then check the WFP World Wide Web site to see where their plant growth data fit into the data set from the larger population of plants grown for CUE-TSIPS in the United States and Ukraine (see page i for addresses).

# AstroPlants Growth Group Data Sheet

## Environment

Student Name 1 \_\_\_\_\_  
 Student Name 2 \_\_\_\_\_  
 Student Name 3 \_\_\_\_\_  
 Student Name 4 \_\_\_\_\_  
 Group Number \_\_\_\_\_

Irradiance: \_\_\_\_\_ no. of bulbs \_\_\_\_\_ distance of plants from bulbs  
 \_\_\_\_\_ wattage of bulbs or  $\mu\text{Em}^2\text{s}^{-1}$  measured under bulbs  
 Average daily temperature of growing environment: \_\_\_\_\_ °C  
 Nutrient used: WFP nutrient solution \_\_\_\_\_ Specify other: \_\_\_\_\_  
 Root medium used: Peatlite \_\_\_\_\_ Specify other: \_\_\_\_\_  
 Seed type: AstroPlants \_\_\_\_\_ Specify other: \_\_\_\_\_  
 Plants grown in PGC? yes / no

Date	das	Character/Activity	Plant Measurements				Statistics			
			Student 1	Student 2	Student 3	Student 4	n	r	x	s
	3	Students: indicate number of seedlings emerged								
	7	thin to 2 plants/film can, number plants								
		<b>Plant Number</b>	1	2	3	4	5	6	7	8
	7	plant height (mm)								
	11	plant height (mm)								
	14	plant height (mm)								
		day to first open flower (das)								

das = days after sowing, n = number of measurements, r = range (maximum minus minimum), x = mean (average), s = standard deviation

# AstroPlants Growth Class Data Sheet

Date \_\_\_\_\_

Teacher Name \_\_\_\_\_

School Name \_\_\_\_\_

School Address \_\_\_\_\_

School Phone (     ) \_\_\_\_\_

Email Address \_\_\_\_\_

**Environment**

Irradiance: \_\_\_\_\_ no. of bulbs \_\_\_\_\_ distance of plants from bulbs  
 \_\_\_\_\_ wattage of bulbs or  $\mu\text{Em}^{-2}\text{s}^{-1}$  measured under bulbs

Average daily temperature of growing environment: \_\_\_\_\_ °C

Nutrient used: WFP nutrient solution \_\_\_\_\_ Specify other: \_\_\_\_\_

Root medium used: Peatlite \_\_\_\_\_ Specify other: \_\_\_\_\_

Seed type used: AstroPlants \_\_\_\_\_ Specify other: \_\_\_\_\_

Plants grown in PGC?    yes / no

## How to use this Class Data Sheet:

This Class Data Sheet can be used for the teacher or students to compile data from one measured character (e.g., plant height, Day 7) taken by groups of students who have completed the AstroPlants Growth Group Data Sheet. This Class Data Sheet can be submitted to the Wisconsin Fast Plants Program to be included in a compilation of statistics from other classes.

Variable Measured \_\_\_\_\_ Date Measured \_\_\_\_\_ das of Measurement \_\_\_\_\_

## Group Data\*

Group	Statistics			Group	Statistics		
	n	r	s		n	r	s
Group 1				Group 7			
Group 2				Group 8			
Group 3				Group 9			
Group 4				Group 10			
Group 5				Group 11			
Group 6				Group 12			

## Class Data

Statistics		
n	r	s

\* taken from AstroPlants Growth Data Sheets  
 das = days after sowing, n = number of measurements, r = range (maximum minus minimum), x = mean (average), s = standard deviation

# Pollination

## Concepts

Pollination is the process of mating in plants; it is the precursor to double fertilization. In flowers, pollen is delivered to the stigma through a wide range of mechanisms that insure an appropriate balance in the genetic makeup of the species. In brassicas, pollen is distributed by bees and other insects. The flower is the device by which the plant recruits the bee. Bees and brassicas have evolved an interdependent relationship.

## Questions

- What is the effect of microgravity on pollination?
- What will be the pollen vector in space? Can a bee fly in microgravity?

## Background

What is a flower? In human eyes it is something to enjoy, with color and fragrance. For many plants, flowers are vital organs of reproduction containing both male and female gametes. For bees and other nectar-feeding animals, flowers are a source of food.

*Symbiosis* is the close association of two or more dissimilar organisms. Such associations can be beneficial to both organisms (*mutualistic*) or detrimental to one (*parasitic*). Symbiotic relationships among species occur frequently in nature. When the two or more species in symbiosis evolve in response to each other, they are said to *coevolve*. Under close examination each symbiotic relationship stands out as an example of miraculous complexity which has emerged. The *coevolution* of bees and brassicas, each dependent upon the other for survival, is such a relationship.

## The Flower

Most flowers have the same basic parts, though they are often arranged in different ways. The five main parts of a flower are the *sepals*, *petals*, *stamens*, *pistil* and *nectaries*. The sepals are the green leaflike structures at the base of the petals that protect the developing flower. The petals are the colored leaflike structures within the sepals.

The stamen has two parts, the *anther* and the *filament*. The anther contains the pollen grains, which contain the male gametes.

The pistil usually has three parts, the *stigma* (which receives the pollen), the *style* (the neck below the stigma) and the *carpel* (or ovary). AstroPlants flowers have two fused carpels, separated by a thin membrane. The carpels house the *ovules*, which contain the female gametes.

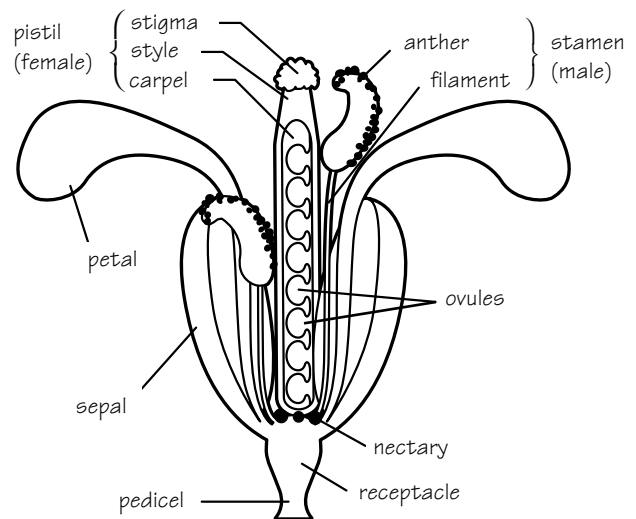

Sugar-rich nectar is secreted by the specialized nectary tissues strategically located in the flower to ensure that nectar-gathering animals will receive pollen from anthers and transmit it to stigmas.

## Investigations of a Gametic Kind

### The Developmental Clock

At about Day 7 in the AstroPlants life cycle, you may have looked down on your plants from the top view and noticed a tightly packed whorl of buds, some of which were larger than others. Each successively smaller bud represented a time interval in the developmental clock of AstroPlants, later marked by the appearance of new flower buds on the shoot.

As your AstroPlants begin to flower, normally the lowest flower on the shoot opens first, followed by the next highest and so forth. By recording the time when the first flower opens and counting the number of successive flowers that open in the intervening 24 hours, you can calculate the average time between successive developmental events that initiate a flower on the shoot apical meristem.

- Can you calculate the number of hours between successive flowers on your AstroPlants?
- How many flowers would you predict will open between the time your first flower opens and when you pollinate your plants?

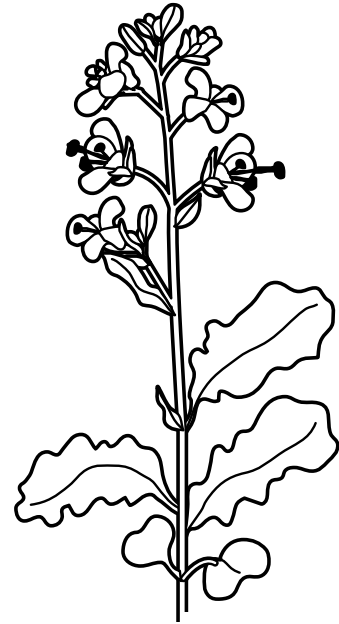

### When is a Flower Open?

The answer to this question is not always as straightforward as it might appear. As you observe the progression of flowers opening, you will notice that as the buds swell the sepals are pushed apart by the enlarging anthers and emerging yellow petals. Eventually the petals (which are slightly rolled) fold outward about halfway up their length, flattening and spreading to reveal their bright yellow color. At this time you might conclude that the flowers were open.

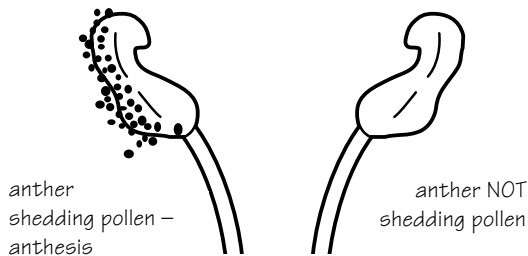

From the perspective of mating, a flower is open when it is capable of providing and receiving pollen. Thus, not until the anthers on the filaments of the stamens open up (*dehisce*) and release their pollen is a flower functionally open.

The shedding of pollen is known as *anthesis*. When you observe a succession of flowers at the shoot apex of your AstroPlants you will observe whether anthesis has occurred by noting the release of the powdery yellow pollen from the anthers. A hand lens can be helpful in detecting anthesis.

Sometimes a flower is inhibited from male function by excessive heat or genetic male sterility. As mentioned in "Understanding the Environment" (page 13) anthers may fail to dehisce at very high relative humidities. This problem can usually be corrected in a few minutes by circulating air over the plant with a fan.

### Gametogenesis

The production of sperm and eggs involves a fundamental sequence of events that characterizes most higher plant and animal life. In plants, meiosis precedes gamete formation and establishes the initial events of sexual reproduction by exchanging and sorting the genes on the chromosomes into the vehicles of genetic transmission and reception that we call gametes: the eggs and sperm.



In AstroPlants the developmental process known as *microsporogenesis* occurs in the developing anthers when the first flower bud of the apical whorl is about one millimeter in diameter and leads to the production of pollen. Within the anthers specialized tissues undergo meiosis to form the *microspores* that eventually become pollen grains. Pollen is the immature stage of the *microgametophyte*, which does not become fully mature until it germinates on a stigma and forms a pollen tube containing two sperm cells and a tube nucleus (see page 53).

At about the same time as the anthers are developing, tissues within the developing pistil of the immature flower bud give rise to a series of ovules. Within each ovule meiotic divisions in the process of *meiosporogenesis* lead to the production of *megaspores*. Through the process of *megagametogenesis* the megaspore develops into a mature *megagametophyte* or embryo sac (Raven, Evert and Eichorn, 1992).

These developmental processes may be subject to perturbations resulting from microgravity, and therefore are included as part of the CUE experiments.

### The Flower and The Bee: Pollination

Brassica pollen is heavy and sticky – unable to be easily wind-borne. For brassicas, bees are marvelously coevolved pollen transferring devices (*vectors*).

Bees depend on the flower for their survival. Sugars in the nectar provide carbohydrates to power flight and life activities. Pollen is the primary source of proteins, fats, vitamins and minerals to build muscular, glandular and skeletal tissues. A colony of bees will collect as much as 44 to 110 pounds of pollen in a season.

A worker bee foraging for pollen will hover momentarily over the flower and use its highly adapted legs for pollen collection (see illustration). The bee's three pairs of legs are evolved to comb pollen from the bee hairs and pack it into the *pollen basket* for transport to the hive.

Each foreleg is equipped with an *antenna cleaner*, a deep notch with a row of small spines, which is used to brush pollen from the antennae. Using the large flat *pollen brushes* on the midlegs, the bee removes the pollen from its head, thorax and forelegs. The pollen is raked off the brushes by the *pollen combs* and packed into the baskets by the *pollen press*.

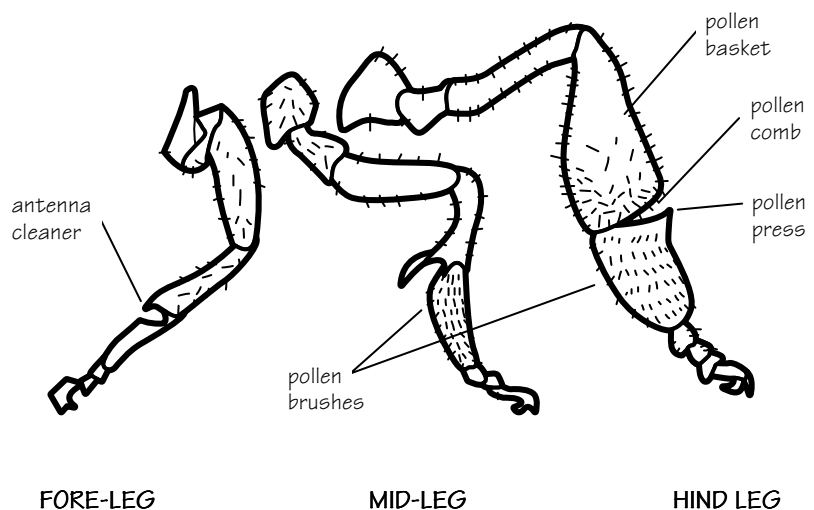

Bees are members of the insect family Apidae, which are unique in that their bodies are covered with feather-like hairs (setae). The bright yellow flower petals act as both beacon and landing pad for the bees, attracting them to the flower and guiding them to the nectaries. The bee drives its head deep into the flower to reach the sweet nectar secreted by the nectaries and brushes against the anthers and stigma. Quantities of pollen are entrapped in its body hairs.

As the bees work from plant to plant, pollen on the bee setae is carried from flower to flower. The transfer of pollen from the anther to the stigma is known as *pollination*. When pollen is transferred from one plant to another, the process is called *cross-pollination*.

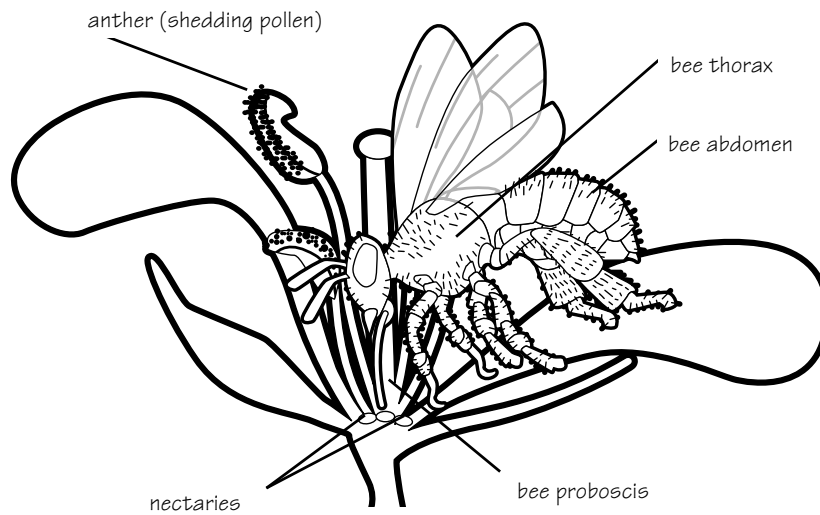

As the bee forages, cross-pollination occurs and genetic information is widely transferred. Some pollen grains are deposited on the sticky surface of each stigma and each compatible pollen grain sends a tube through the style to the ovule to complete fertilization. Within three days of fertilization, petals drop and the pistil begins to elongate to form a pod as the seeds develop inside.

### Are We Compatible?

For AstroPlants and many other brassicas, the act of pollination does not insure fertilization and seed formation. Some brassicas contain recognition compounds called glycoproteins which are unique to each plant. These compounds enable the plant to recognize "self," resulting in the abortion of the plant's own pollen. This genetically controlled prevention of fertilization with "self" pollen is called *self-incompatibility*. Only "non-self" pollen is able to germinate and effect fertilization.

In order for pollen germination and fertilization to occur, pollen must travel from one brassica plant to the stigma of a different brassica plant in the process of cross-pollination. Bees take care of this problem naturally as they move from plant to plant in search of nectar and pollen. AstroPlants are therefore *cross-compatible* and *self-incompatible*.

## Making Beesticks, Pollinating and Observing Pollen

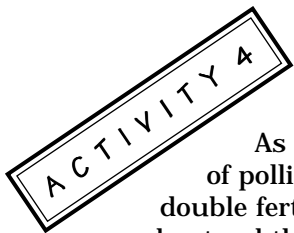

### Introduction

As their plants come into flower, students need to be prepared to pollinate. The act of pollination is the prelude to the beginning of a new generation that starts with double fertilization. In preparation for pollination of their plants, students will need to understand the developmental biology leading to the production of male and female gametes (sperm and egg) and the concepts associated with the coevolutionary relationships between flowers and their pollinators.

It is unknown whether natural pollen vectors on Earth, such as bees, flies, hummingbirds and bats, are capable of flight or transit between and among flowers in conditions of microgravity. For this reason, in the B-STIC experiment, the CUE mission's Payload Specialist will be simulating the flight of a bee using an artificial pollination device to transfer pollen among the AstroPlants flowers.

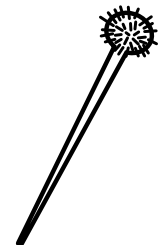

**Question:** How is effective pollination carried out?

**Sample Hypothesis:** The transfer of adequate numbers of viable, compatible pollen from the anthers of one plant to the stigmas of another plant will result in effective pollination.

### Design

- With a beestick as the vector, pollen is collected from the anthers of various plants and transferred to the stigmas of other plants.
- Students will record data on their Floral Clock Student Data Sheet (page 51).
- It is important for each class to have at least **two extra sets** of four film can wick pots (16 plants) in PGCs to serve as **unpollinated control plants**. The extra PGCs should have been planted along with and maintained in the same manner as the experimental PGCs.

### Time Frame

A period of 16 days from the sowing of seed is required for the growth of the AstroPlants and the completion of the activity. Making beesticks will require about 15 minutes and should be done one to two days prior to pollination. Observation of the bee and a lesson on the relationship of bees and the AstroPlants flower in pollination could take one 50 minute class period. The pollination will require one 50 minute class period.

### Learning Objectives

In participating in this activity students will:

- understand flowering as the sexually mature stage of plant development;
- understand where and how ovules and pollen originate (male and female gamete formation);
- explore the parts of the flower and the role that each part plays in reproduction;
- observe the reproductive tissues of plants, including pollen and stigma, under magnification;
- understand the interdependent coevolutionary relationship of bees and brassicas; and
- begin the process of reproduction in their AstroPlants by performing a pollination using a beestick, setting the stage for future developmental events.

### Materials

- flowering AstroPlants (Day 14 to 16)
- forceps
- two dissection strips (page 23)
- 2 cm wide clear adhesive tape
- dried bees
- toothpicks
- glue (e.g., Duco® Cement)
- hand lens or microscope

### Procedure: Making Beesticks

1. One to two days prior to pollination, students should make beesticks. While making beesticks the teacher may wish to have students observe the anatomy of a bee, focusing on the legs and proboscis, to reinforce an understanding of the design (role and function) of the bee in relation to the flower.

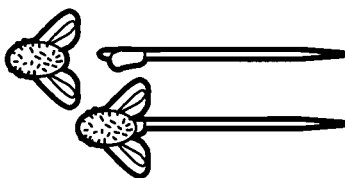
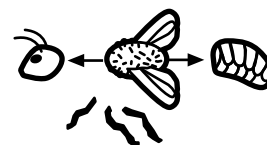

2. Carefully remove the legs, head and abdomen of the dried bee, leaving the fuzzy thorax. Pollination can be performed with "whole bee" beesticks as well.
3. Place a drop of fast-drying glue on the tip of a toothpick. Carefully push the toothpick into the top of the thorax of the bee. Remove the wings. Let the beesticks dry overnight.

### Procedure: Setting the Floral Clock

1. At a time between **Day 14** and **Day 16** when five or more flowers are open on each plant in the PGC, cross-pollinate all open flowers on each plant with a beestick by gently rolling the bee thorax back and forth over the anthers of flowers of several plants until yellow pollen can be observed on the hairs.

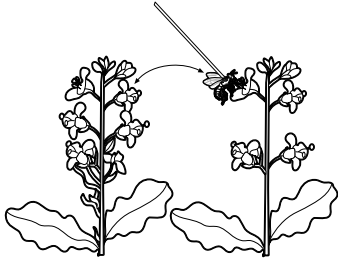

Moving to other plants and repeating the rolling motion over the anthers and the stigma of each pistil, students should make sure to deposit pollen collected on the beestick on to the stigma of each flower. Students from one group may wish to "fly" their bees to flowers of other groups. Buzz!

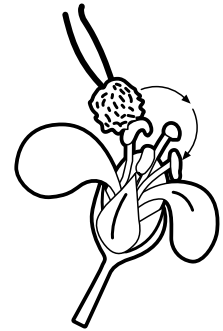

2. Take the **top open flower** of the first plant and carefully remove it with a forceps. Place it on the sticky tape of a dissection strip.
3. While observing with a hand lens or microscope, carefully remove the flower parts, noting their relative positions on the receptacle, **making sure not to damage the pistil**. Refer to the illustration on page 43 for help in identifying the floral parts. You and your students may want to test the nectaries for the presence of glucose (write to Wisconsin Fast Plants for the activity "The Hunt for Glucose - A Flower's Treasure").
4. Slip the ruler on a second dissection strip (without tape on it) under the first strip. Each student should measure the length of the pistil from the receptacle to the top of the stigma and record the pistil length on his/her Floral Clock Student Data Sheet (page 51).
5. Remove the top open flower of the second plant, measure the length of the pistil and record the data on the Floral Clock Student Data Sheet in the column under the number of the second plant.

- With higher powered microscopes students could observe magnified views of pollen trapped on the stigmas of dissected flowers or on a beestick.
- While pollinating, students might also observe the pollen trapped on the tape of a dissection strip.
- Alternatively, look at the pollen on the stigmas or on the beestick with a hand lens.
- A beestick with pollen can be rolled over the sticky tape on the dissection strip. Observation under a magnifier will reveal pollen attached to the bee setae.



magnified  
pollen grains on  
bee setae

6. Note that flowers on the plants are produced and open in a sequence spiraling up the flower stem. Starting with the next flower down from the one that you removed, **number the remaining flowers as 4, 3, 2 and 1** as shown in the illustration on page 49, with number 1 being the oldest flower.
  - With a sharp pair of fine scissors, carefully snip off all additional remaining flowers below flower number 1 (including side shoots), leaving only the four open flowers that have been numbered.
  - Snip off the developing apical flower shoot and buds above the four remaining open flowers. This is known as *terminalizing* the plant.

7. Returning to the four remaining flowers, note the position of the stigmas relative to the tall anthers. Is the stigma below (-1), equal to (0) or above (+1) the tall anthers? Record this information for each flower of both plants on the Floral Clock Student Data Sheet.

- Is there a relationship between flower age and the position of the stigma relative to the level of the four tall anthers?

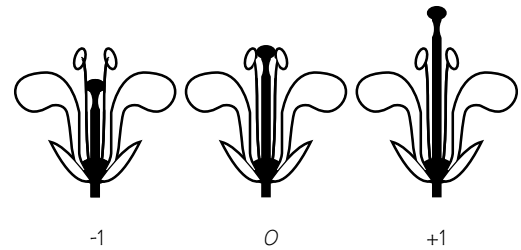

8. Be sure to measure the length of the uppermost open flower of each plant in the set that was grown for the unpollinated controls. Data for the unpollinated control sets should be recorded on a separate Floral Clock Student Data Sheet.

9. Before leaving the plants be sure that each of the remaining stigmas has been adequately pollinated by the beestick. Can you see any pollen on the stigmas? Check with a hand lens.

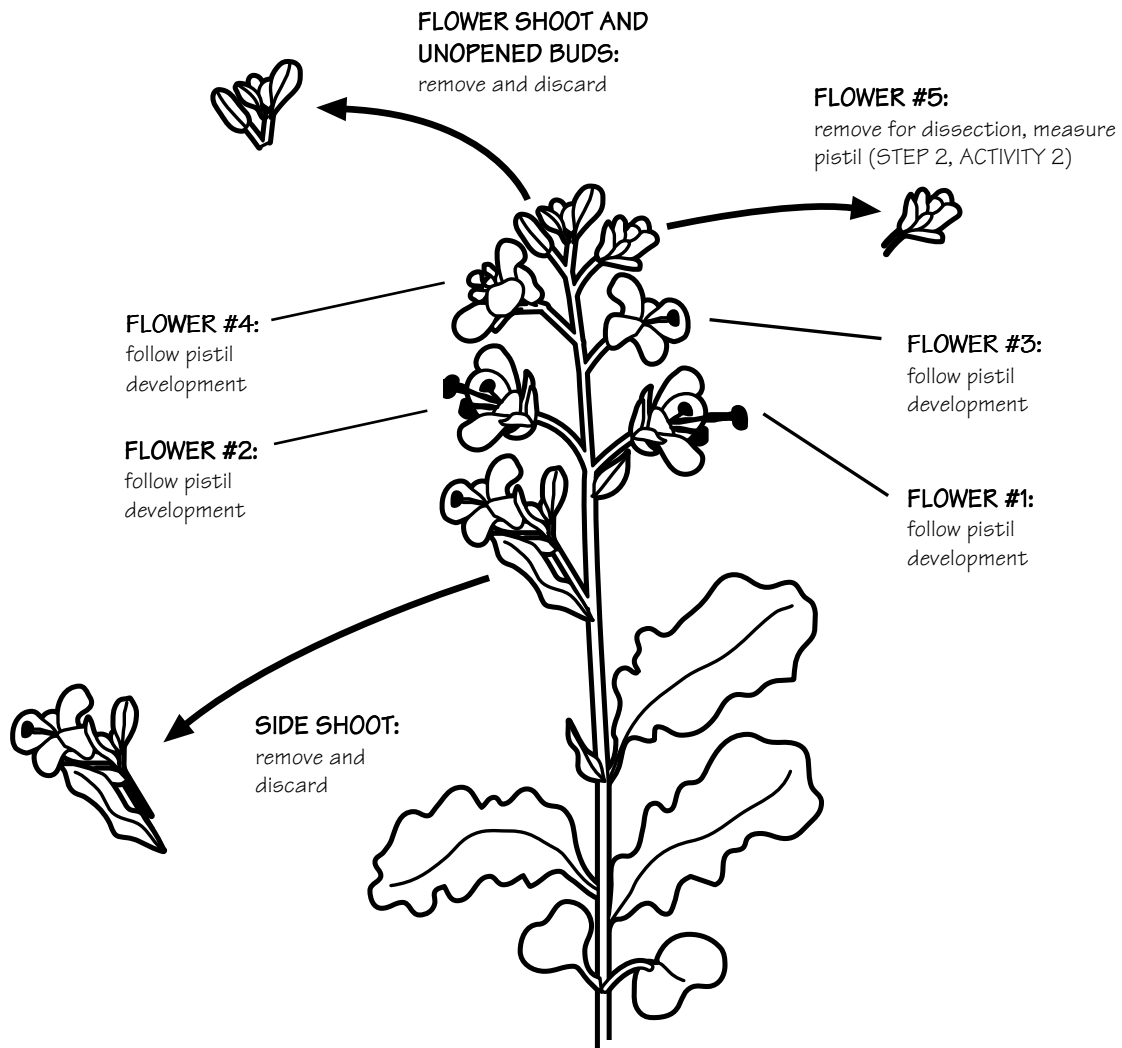

### Concluding Activities and Questions

The completion of pollination sets the floral clock at "0 dap" (days after pollination). Activities 5 and 6 in the section "Double Fertilization and Post-Fertilization Events" involve observing, recording and analyzing pistil development as an indication of successful pollination. In participating in these activities students will complete their Floral Clock Student Data Sheets. After completing Activity 4, have students consider the following:

- What is the relative importance of each flower part in relation to pollination and sexual reproduction? Are some parts more important than others? Why?
- Does the pistil continue to elongate after the flower is functionally open? Even if the flower is not pollinated?
- How many flowers on average open each day once the first flower has opened?
- What is the average amount of time (in hours) between the development of one flower and its nearest neighbor?

"People from a planet without flowers would think we must be mad with joy... to have such things."

- Iris Murdoch

### Extensions

For activities on observing and experimenting with pollen germination in vitro under the microscope and on observing compatible and incompatible pollen-stigma interactions and pollen tube growth in the style and ovaries, write to Wisconsin Fast Plants for the activities "Pollen Germination" and "Pollen-Stigma Interactions and Pollen Tube Growth."

With a separate third set of plants, try self-pollinating and compare the amount of seed produced with the seed produced by the cross-pollinated plants.

# Floral Clock Student Data Sheet

## Environment

Student Name \_\_\_\_\_ Irradiance: \_\_\_\_\_ no. of bulbs \_\_\_\_\_ distance of plants from bulbs \_\_\_\_\_  
 Plant Type: (circle one) \_\_\_\_\_ wattage of bulbs or  $\mu\text{Em}^{-2}\text{s}^{-1}$  measured under bulbs \_\_\_\_\_  
 pollinated \_\_\_\_\_ unpollinated \_\_\_\_\_  
 Average daily temperature of growing environment: \_\_\_\_\_ °C  
 Nutrient used: WFP nutrient solution \_\_\_\_\_ Specify other: \_\_\_\_\_  
 Root medium used: Peatlite \_\_\_\_\_ Specify other: \_\_\_\_\_  
 Seed type: AstroPlants \_\_\_\_\_ Specify other: \_\_\_\_\_  
 Plants grown in PGC? yes / no \_\_\_\_\_

Plant No. \_\_\_\_\_

Date	dap	Character/Activity	Measurements				Statistics							
			1	2	3	4	n	r	x	s				
	0	pistil length top flower (mm)												
		number pollinated flowers												
		<b>Flower/Pod Number</b>												
	0	note position of stigma above, at or below anthers (+1, 0, -1)*												
		pistil length (mm)												
		pistil length (mm)												
		pistil length (mm)												
		est. no. developing seeds (#)												
		pistil length (mm)												
		pistil length (mm)												
		harvest & count seeds/pod												
		viability test (+ / -)												

Plant No. \_\_\_\_\_

Date	dap	Character/Activity	Measurements				Statistics							
			1	2	3	4	n	r	x	s				

\* when noting stigma position: +1 = above anthers, 0 = at level of anthers, -1 = below the level of anthers

dap = days after pollination, n = number of measurements, r = range (maximum minus minimum), x = mean (average), s = standard deviation

The dap column is left blank on this data sheet because the timing of activities depends on the rate of development in each students' plants. For a guide of approximate dap, see the "CUE-TSIPS Mission Calendar" (page 29).

# Floral Clock Class Data Sheet

Date \_\_\_\_\_

Teacher Name \_\_\_\_\_

School Name \_\_\_\_\_

School Address \_\_\_\_\_

School Phone (     ) \_\_\_\_\_

Email Address \_\_\_\_\_

**Environment**

Irradiance: \_\_\_\_\_ no. of bulbs \_\_\_\_\_ distance of plants from bulbs \_\_\_\_\_  
 wattage of bulbs or  $\mu\text{Em}^{-2}\text{s}^{-1}$  measured under bulbs \_\_\_\_\_  
 Average daily temperature of growing environment: \_\_\_\_\_ °C  
 Nutrient used: WFP nutrient solution \_\_\_\_\_ Specify other: \_\_\_\_\_  
 Root medium used: Peatlite \_\_\_\_\_ Specify other: \_\_\_\_\_  
 Seed type used: AstroPlants \_\_\_\_\_ Specify other: \_\_\_\_\_  
 Plants grown in PGC?    yes / no

## How to use this Class Data Sheet:

This Class Data Sheet can be used for the teacher or students to compile data from one measured character (e.g., pistil length, 14 dap) taken by students who have completed the Floral Clock Student Data Sheet. Each group of students should compile summary statistics for the group's eight plants. These statistics should then be entered in the chart below. From the Group Data chart, the class data can be derived. This Class Data Sheet can be copied and submitted to the Wisconsin Fast Plants Program to be included in a compilation of statistics from other classes.

Variable Measured \_\_\_\_\_ Date Measured \_\_\_\_\_ dap of Measurement \_\_\_\_\_

### Group Data

Group	Statistics			Group	Statistics			
	n	r	x		s	n	r	x
Group 1				Group 7				
Group 2				Group 8				
Group 3				Group 9				
Group 4				Group 10				
Group 5				Group 11				
Group 6				Group 12				

### Class Data

Statistics			
n	r	x	s

dap = days after pollination, n = number of measurements, r = range (maximum minus minimum), x = mean (average), s = standard deviation



# Double Fertilization and Post - Fertilization Events

## Concepts

Fertilization is the event in sexual reproduction which follows pollination. In higher plants, two sperm are involved in fertilization, reaching the ovule via a pollen tube from the germinating pollen grains. One sperm fertilizes the egg cell within the embryo sac to produce the zygote and begin the new generation. The other combines with the fusion nucleus to produce the *endosperm*, a special tissue that nourishes the developing embryo. Fertilization also stimulates the growth of the maternal tissue (seed pod or fruit) supporting the developing seed. In AstroPlants the fertilized egg cell develops through various stages over the next 20 days until it becomes a mature quiescent embryo, the seed.

## Questions

- What is the effect of microgravity on fertilization and embryo development?
- Will the maternal parent be affected by microgravity? Will fruits develop?

## Background

What happens between fertilization and seed harvest? After pollination, each compatible pollen grain adhering to the stigma sends through the style a pollen tube which carries two male *gametes* (sperm) to the *ovule*, where the *egg* and other *cell nuclei* are housed in the *embryo sac*. One sperm unites with the egg cell ( $n$ ) to produce a *zygote* ( $2n$ ) which becomes the embryo. The second sperm ( $n$ ) unites with the diploid fusion nucleus ( $2n$ ) to form the triploid *endosperm* ( $3n$ ), the energy source for the developing embryo. This process is known as *double fertilization*.

Within two to three days after fertilization, the pistil begins to elongate and swell to accommodate the enlarging ovules. The sepals and petals wither and drop off, having completed their functions.

Within the ovules, the embryos differentiate and enlarge through a series of developmental stages, known collectively as *embryogenesis*. Enlarging also within the ovule is the endosperm. In the latter stages of embryo development in brassicas, the nutrient reserves in the endosperm are used by the embryo and the space that was filled by the endosperm is occupied by the enlarging embryo.

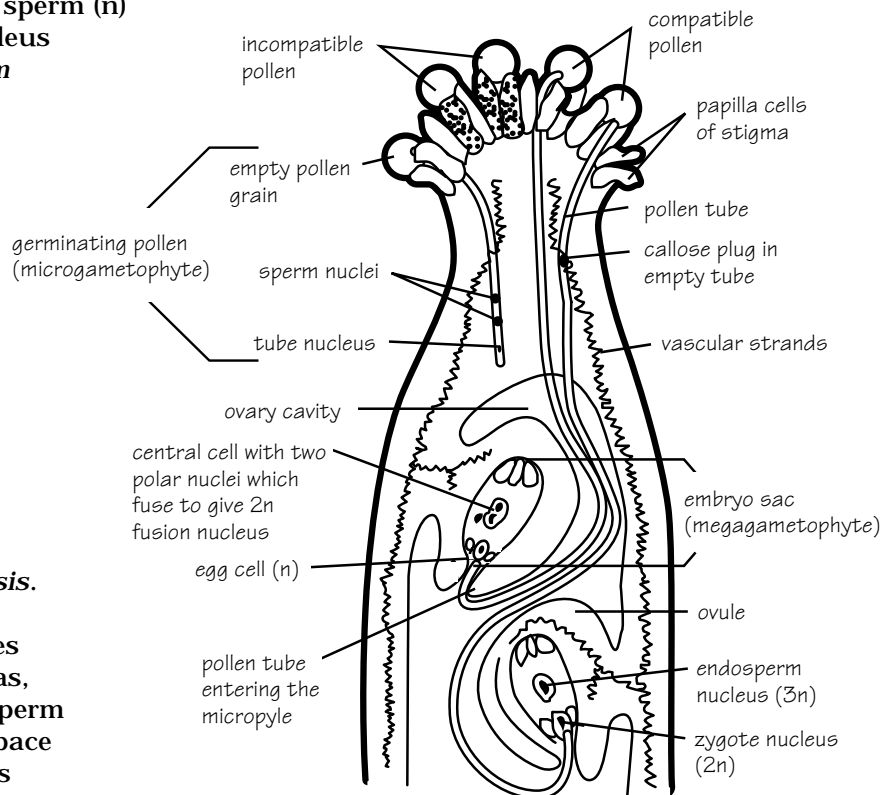

In cereal crops, such as wheat, rice and corn, endosperm is not used by the enlarging embryo and remains a major portion of the seed as a starchy energy source for the germinating seedling.

Through the development of the seed, the plant has solved the problem of packaging its new generation to survive until favorable conditions for growth return. As the seed matures, the walls of each ovule develop into a protective seed coat and the entire ovary becomes a fruit (seed pod). In AstroPlants, embryos mature into seeds in 20 days after successful pollination.

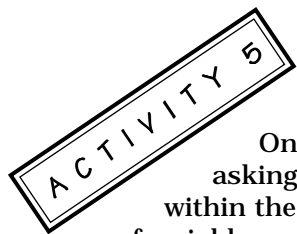

## Measuring Time on the Floral Clock

### Introduction

One of the primary aspects of the questions that Dr. Musgrave and Dr. Popova are asking relates to embryogenesis, the orchestrated sequence of developmental events within the ovule and supporting maternal tissues that ultimately leads to the development of a viable seed (see "Mission Information," page 92). The failure to produce significant quantities of viable seed in past missions raises the question as to whether normal embryogenesis is affected in microgravity. In order to ask this question, an understanding of normal embryogenic events in AstroPlants is important.

Successful embryo and endosperm development is accompanied by rapid elongation and enlargement of the pistil which serves as supportive nourishing maternal tissue. There is a strong interdependency between the developing embryos, endosperm, ovule and maternal tissues of the pod: it is believed that hormones produced by the developing embryos and endosperm regulate the growth and expansion of maternal tissue (Stage G in the life cycle, page 12). When either embryo or endosperm fails in its development, ovule development also ceases and pod enlargement may be slowed.

At the same time vigorous pod development supported by a healthy plant is necessary for the developing embryo and endosperm in the ovule. Seed failure can result if the maternal plant comes under excessive environmental stress, as from excessive heat, water stress or nutrient deprivation.

Fertilization in sexually reproducing organisms represents the onset of the next generation. Following double fertilization in plants, the most visible event is the rapid wasting of all those flower parts which are no longer needed by the plant. Sepals, petals and stamens wither and fall. Nectaries dry up. At the same time, within a few hours of fertilization, the pistil with its complement of fertilized ovules begins rapid development.

This activity provides students with an opportunity to follow the results of student pollination by measuring the increasing length of the pistil at regular intervals until mature seeds are formed and harvested. Upon harvest, viability of the seeds will also be tested. In Activity 6, students dissect pods at various stages of development in order to investigate the stages in embryogenesis.

Students will discover and document what constitutes normal embryo development in AstroPlants through observation and drawing. An important part of this investigation is to determine whether the students results will correspond with the data from the B-STIC experiments.

**Question:** What are the indicators of normal fertilization and post-fertilization development that follow successful pollination?

**Sample Hypothesis:** Flower parts other than the pistil wither. The pistil enlarges to become a pod containing developing seed. At maturity the pod and seeds dry. Viable seeds germinate.

## Design

- At specified intervals following pollination, measure the length of the pistil, observe developing embryos and endosperm and estimate the number of developing embryos. At maturity, harvest seed and verify viability with germination test. As a control follow the development of pistils of the unpollinated control plants.
- Students will record observations and measurements on the Floral Clock Student Data Sheet (page 51).

## Time Frame

A period of 36 days from the sowing of seed is required for the growth of the AstroPlants and the completion of this activity. The time required each class period will vary according to the observations or measurements being made. Time will be required on seven separate days through the course of this activity, specified in the procedure.

## Learning Objectives

In participating in this activity students will:

- learn to make observations and accurate measurements of pistil enlargement;
- understand the role of pollination and compatible pollen germination as a precursor to double fertilization (Stage F, page 12);
- understand that following double fertilization a complex sequence of interdependent developmental events occurs over a period of 20 days that results in the production of viable seed for a new generation in the spiral of life (Stages F, G, H and I, page 12);
- understand the unique nature of double fertilization in higher plants in which embryo and endosperm are interdependent specialized tissues within the ovule that function in normal seed development (Stage G, page 12);
- understand the interdependent relationship of developing maternal tissue and developing fertilized ovules (Stage G, page 12);
- understand that the development of a viable seed requires a healthy (environmentally non-stressed) plant during the period of growth in which the fertilized ovules are developing into seed.

## Materials

- flowering AstroPlants, post-pollination
- dissection strips (page 23)
- fine scissors
- fine-tipped forceps and fine dissecting needles (e.g., tuberculin syringes with #23 or #25 needles)
- clear double stick tape
- 2 cm wide clear adhesive tape
- seed envelope
- glass microscope slide
- water and dropper
- sharp cutting blade

## Procedure

1. At **3 dap** (days after pollination) students will notice that the flower parts that were important in pollination have withered and fallen from the plant.
  - Using a dissection strip without tape as a ruler, carefully measure the length of each expanding pistil, recording its length to the nearest millimeter in the appropriate column of the Floral Clock Student Data Sheet according to its position number. Remember the highest number (4) is the most apical (top) flower.

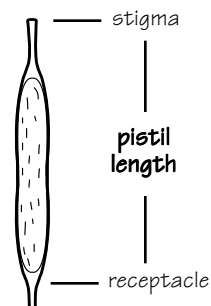

2. Repeat Step 1 at **6 dap** and **9 dap**.
3. Students will notice that the pods at **9 dap**, in addition to elongating, have swollen around what appears to be developing seeds or ovules (Stage H in the life cycle, page 12).
  - Carefully hold the plants up to the light. Can you see the outlines of the developing ovules within the pods?
  - Estimate the number of developing seeds in each pod. Record the information on your Floral Clock Student Data Sheet. At harvesting you will be able to verify your estimations by counting the seed.
4. If students are **not** doing Activity 6 (embryo dissection), each pair may sacrifice one pod from one of their plants in order to observe the developing embryos within the ovules at **9 dap**.



- Proceed by choosing a pod in which several ovules are visible. Carefully snip it off with a fine scissors.
- Cut the pod in half with a sharp blade and give one half to each student. Place each half on the sticky tape of another dissection strip.
- Holding one end of the half-pod, use a sharp needle to pry it open along its length to expose the ovules which look like tiny green grapes. With the needle or forceps, detach two or three ovules from the pod and place them in a cluster on the sticky tape of the dissection strip. Put the pod aside on wet paper toweling to stay fresh.

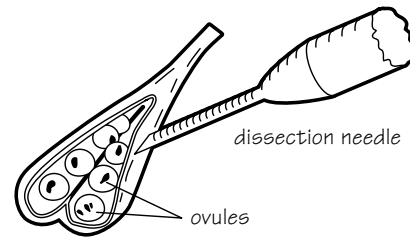

- With a dropper place a very small drop of water over the ovules on the dissection strip.
- With two needles, hold and squeeze the first ovule, cutting into it with one needle. A tiny green object should squirt out along with some cloudy material (the endosperm).

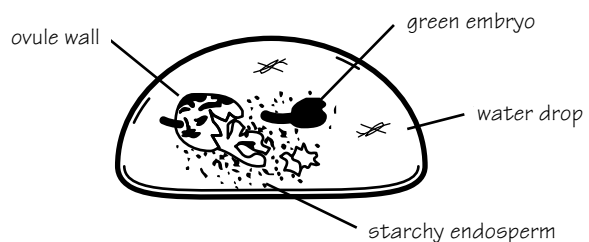
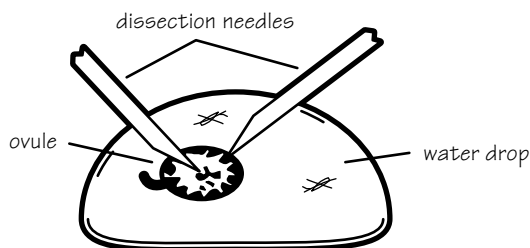

- With a hand lens or microscope, observe the object. Does it look like any of the illustrated embryos on page 64? Which stage?
- If you didn't succeed with the first one, try another ovule.
- If you have a microscope, observe the ovule under higher magnification, then draw it.

5. At **12 dap**, repeat Step 1 and record the data on the Floral Clock Student Data Sheet.
  - By this time, the plant's lower leaves may be starting to turn yellow or even wither and dry. This is the normal succession in the life cycle of the plant, particularly if it is supporting a number of pods with developing seeds.
  - If a plant fails to develop any seeds, it will frequently remain green and continue to produce flowers from side shoots developing in the axils of leaves. This should be the case in the unpollinated control plants, if a plant has been severely stressed so that embryogeny has failed or if it is genetically or phenotypically *sterile* (incapable of producing offspring).
  
6. At **21 dap**, plants are now approaching maturity. Normally AstroPlants embryos have fully developed by 18 to 20 dap, at which time stem and pods of the aging parent plant begin to turn yellow along with the leaves and the seed coat begin to turn brown (Stage I in the life cycle, page 12). This is the time that water can be withheld from the plants to encourage seed ripening.
  - At **21 dap**, students should take a final pistil length measurement.
  - Empty the water from the reservoir and remove the capillary mats. Keep the plants under the lightbank and let them dry.
  
7. In **about a week**, or when the pods are dry, harvest the seeds from each of your pods onto separate loops of sticky tape. Record the plant and pod number on the tape.
  - Count and record the number of seeds for each pod on the Floral Clock Student Data Sheet.
  - Did the number of seeds in each pod agree with the estimates you made at 9 dap?
  - As you harvest, notice any unusual seed. If these are of interest with you, tape them to a card where they can be examined or germinated later.
  
8. Take a sample of two seeds from each pod and test their viability in a bottle cap seed germinator according to the instructions on page 75.

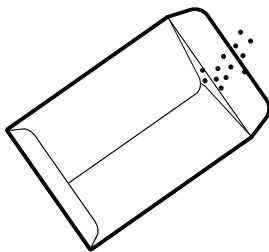
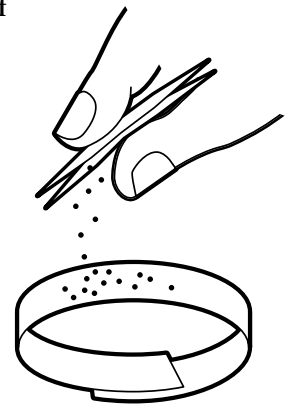

- **Two days later**, record the seed viability on the Floral Clock Student Data Sheet. On the data sheet, "+" indicates a viable seed and "-" indicates a nonviable seed.
- Combine all the other seed in a bulk and store it in a seed or coin envelope within a sealed container with indicator silica gel (drying compound, see page 94). Seed stored dry and cool in a refrigerator or freezer will stay viable for many years.

### Concluding Activities and Questions

After setting the floral clock with the pollination activity (Activity 4), students have followed the course of reproductive development by observing and measuring pistil enlargement and seed production and completing the Floral Clock Student Data Sheet. Combine the student data into group data, and then into a class data summary using the Floral Clock Class Data Sheet (page 52). See "CUE-TSIPS Science and Technology" for a review of data analysis (page 18).

If available, use data analysis software to create graphical and statistical summaries of class data. Notice how the various statistical notations (range, mean and standard deviation) change over time from pollination. Have students consider the following:

- From a class frequency histogram and statistical summary, does the measured plant character of pod length on a particular day exhibit a normal distribution within the class population?
- Do individual pod lengths for each day fall within one or two standard deviations of the class mean? Do students consider their post-fertilization events to be normal? Why or why not?
- Are there any "abnormal" seeds? They may be tested for viability.
- From a graph of the average rate of increase in pod length over time, is there a period in post-fertilization development in which the increase in pod length is fastest?
- Is there a relationship between the number of developing seed and pod length?
- How do graphs of pod length increase over time compare between the pollinated and unpollinated sets of plants?

Classes can submit the Floral Clock Class Data Sheet for both experimental and unpollinated control plants to the Wisconsin Fast Plants Program and then check the WFP World Wide Web site to see where their plant growth data fit into the data set from the larger population of plants grown for CUE-TSIPS in the United States and Ukraine (see page i for addresses).

### Extension

For an activity investigating the role of plant hormones in the regulation of pod enlargement, write to Wisconsin Fast Plants for "Hormone-Induced Parthenocarpy in Rapid-Cycling *Brassica rapa*."

# ACTIVITY 6

## Embryogenesis: Going for the Globular!

### Introduction

Following *double fertilization*, four complex processes are triggered. The ovary wall and related maternal structures rapidly grow to become the fruit tissue (the pod) surrounding the developing seeds. Each ovule within the fruit enlarges to accommodate the developing endosperm and embryo. The various outer cell layers of the ovule (*integuments*) eventually become the seed coat. Within the embryo sac, the triploid endosperm nuclei divides very rapidly to form the nutrient-rich, starchy liquid endosperm. The liquid endosperm provides nutrients to the developing embryo.

Since fertilization, the zygote has undergone several mitotic divisions. The first few divisions produced a strand of eight cells known as the *suspensor*, which is attached to the embryo. The suspensor orients the developing embryo within the ovule and is thought to serve as an “umbilical cord,” as it passes nutrients from the endosperm to the embryo cells. The basal cell of the suspensor anchors the developing embryo and orients the embryonic root tip near the *micropyle*, a hole in the integuments where the pollen tube entered. At the tip of the suspensor, repeated cell divisions give rise to the very young *globular embryo* (page 64).

Immersed in the nutrient-rich endosperm, the embryo develops rapidly. By Day 7, the embryo becomes flattened and bilaterally symmetric with two lobes which will become the cotyledons. This is the *heart stage*.

As its development continues, the embryo elongates into the *torpedo stage*. At this stage the embryo produces chlorophyll and becomes green. Elongation of the embryonic hypocotyl separates the *root apical meristem* from the *shoot apical meristem*, which is hidden between the embryonic cotyledons.

As the embryo enlarges it consumes space formerly occupied by the endosperm. To package the enlarging embryo, the cotyledons fold around the hypocotyl, now curved within the ovule; this is the *walking stick stage*. By Day 20, the walls of the ovule (the *integuments*) harden and become the seed coat (*testa*) and the embryo within desiccates to become a seed (Stages I and J, page 12). As maturation proceeds within the enlarged folded embryo, the starch reserves within the embryonic cotyledons are converted to lipids as the final form of energy storage.

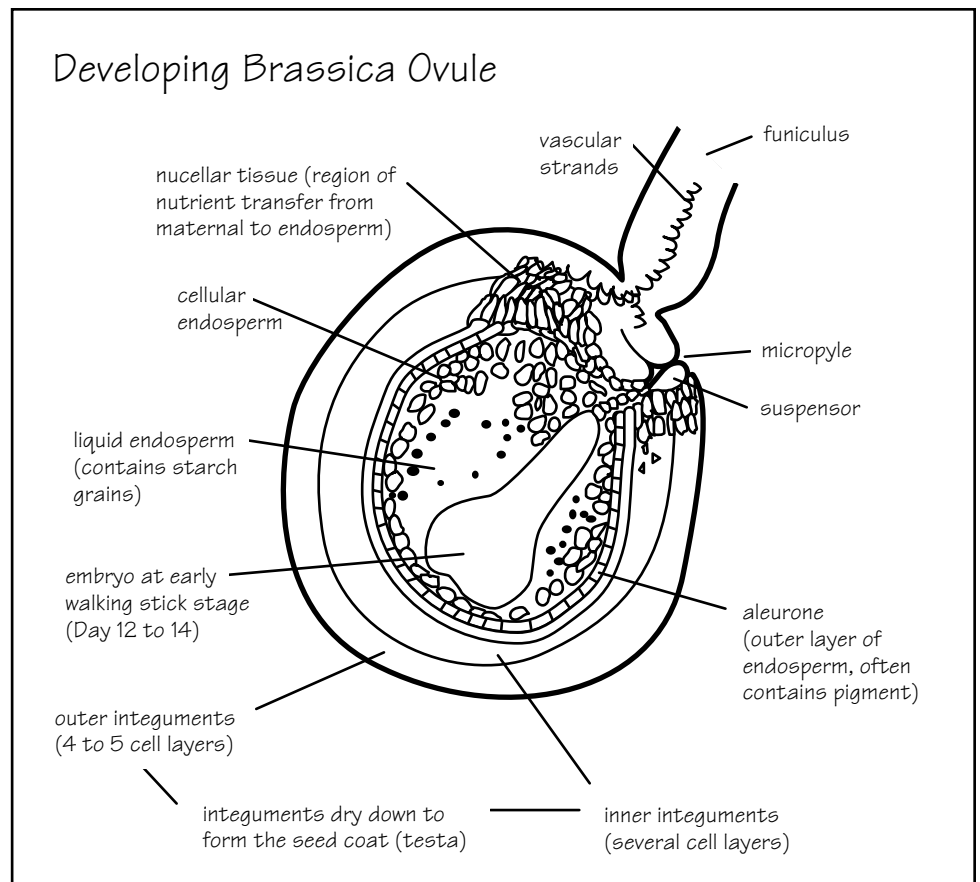

There are many questions that remain unanswered in developmental embryology – perhaps you and your students can answer some of them.

### Questions

- What is the normal sequence of embryo development within the ovules of AstroPlants?
- Can your students identify the various stages in the developmental continuum from embryo to mature seed?
- Can your students record, draw to scale and estimate the relative sizes of the embryo at various stages of development?

**Sample Hypothesis:** Normal embryogenesis proceeds rapidly within the developing seed from a single-celled zygote through recognizable stages of increasing size and complexity ending in a dried seed.

### Design

- \* At specified intervals following pollination, remove embryos from ovules, draw to scale various stages and measure embryo sizes. Construct a developmental chart of embryogenesis.
- Students will record observations and measurements on the Ovule and Embryo Student Data Sheet (page 65).

### Time Frame

A period of 36 days from the sowing of seed is required for the growth of the AstroPlants and the completion of Activities 5 and 6. The time required for the embryogenesis activity will vary depending on the amount of class time spent in dissecting embryos. A minimum of two 50 minute class periods is recommended, one for students to practice and develop their dissection and drawing skills and one or more to examine and record the stages of embryogenesis. The number of periods spent on embryo dissection depends on the timing of the dissections students wish to make.

### Learning Objectives

In participating in this activity students will achieve the learning objectives presented for Activity 5 (page 55). In addition, students will:

- learn to dissect embryos from ovules in developing pods, improving their hand-eye coordination;
- learn that embryogenesis is a continuum of development from a very small spherical group of cells to a complex multidimensional, multicellular organism;
- learn how an embryo can enlarge within the limited confines of the ovule and become "packaged" in preparation for desiccation and quiescence as a seed (Stage I of the life cycle, page 12);
- learn to make accurate descriptive observations of specimens under the microscope, draw carefully "to scale," and record and analyze data obtained from the drawings;
- learn to construct a model embryonic development that can be compared to the development that occurs in plants grown in microgravity.

### Materials

- fresh or fixed pods of AstroPlants at various stages of development
  - for a range of embryo stages suitable for initial dissection, ovules sampled between 6 and 12 days after pollination are best, these should provide stages between heart and walking stick
  - after developing dissection skills, sample ovules from plants 3 to 6 days after pollination
  - see page 98 for instruction on fixing pods
- dissecting microscope with 20 to 40X magnification
- fine-tipped forceps and fine dissecting needles (e.g., tuberculin syringes with #23 or #25 needles)
- dissection strips (page 23)
- 2 cm wide clear adhesive tape
- clear double stick tape
- fine scissors or cutting blade
- water and dropper



**Procedure**

1. **At the desired day after pollination (dap)**, students should use fine scissors to remove one pod from one of their two plants. Place the pod on the sticky tape of the dissection strip aligning it longitudinally on the scale.
2. Measure and make a drawing of the pod "to scale" in a lab notebook.
3. Using the dissection needles or a sharp blade, cut along one seam of the pod where the two carpels are fused. Pry open the pod to reveal the ovules aligned within the carpel; each ovule is attached to the vascular strands by its funiculus. You will also see a thin paper-like septum separating the ovules in each carpel.

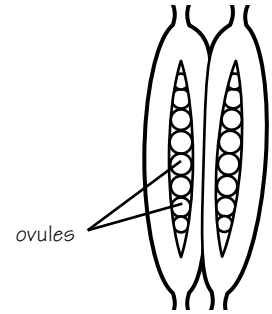

4. Observe the opened pod with a hand lens or under a dissecting microscope. In a lab notebook, make a drawing "to scale" of what you observe.
5. Remove an ovule from the opened pod with fine forceps or dissecting needles, keeping a portion of the funiculus attached to the ovule. Then transfer the ovule onto the sticky tape on a dissection strip. Measure and record the length of the ovule next to the first circle on the Ovule and Embryo Student Data Sheet.
6. With a pipette, transfer a small drop of water to cover the ovule on the sticky tape of the dissection strip. Alternatively a drop of iodine potassium iodide (IKI) staining solution (page 98) can be used in the dissection, in which case any cells or tissues containing starch will turn blue or purple.
7. Place the opened pod with remaining ovules on moist paper toweling in a covered petri dish. This will keep it fresh for further sampling.
8. Place the dissection strip under a dissecting microscope and observe the ovule, noting the funiculus attachment and the micropyle.

- If the ovule is illuminated from below, students may be able to see the indistinct embryo within the ovule. This will depend on the stage of embryo development.

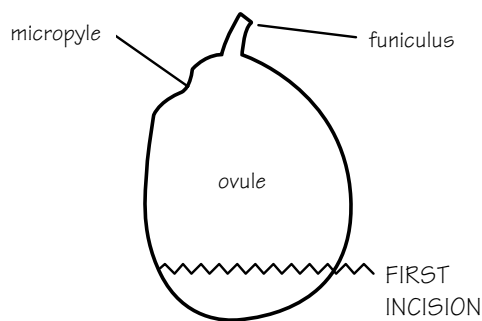

9. With needles make an incision across the ovule at the end opposite the funiculus. As this cut is made, the embryo may float out into the water along with the cloudy starchy liquid endosperm.

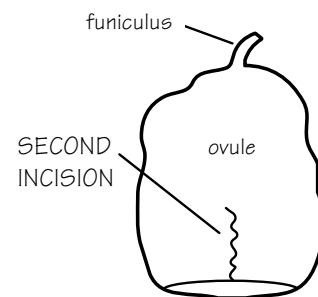

- Make a second incision perpendicular to the first and using dissection needles gently pull open the integuments. Embryos at **9 dap** will generally be visible once the seed coat is open.

- If the embryo is not visible, slowly and carefully remove small pieces of the integuments, working toward the micropylar end.

Young embryos in the heart and globular stages are found surrounded by a funnel of aleurone and nucellar tissue from the torn embryo sac. The young embryo is immersed in cellular endosperm and is anchored by the suspensor in the integuments at the base of the funnel.

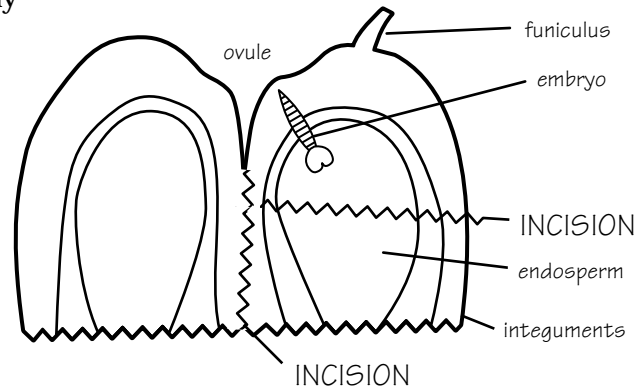

- Continue to carefully tease out the embryo and, if possible, its attached suspensor.

10. Once the embryo has been removed, students may wish to increase the magnification under the microscope for viewing and drawing.

- Under an appropriate magnification, slide a second dissection strip under the one holding the embryo in the water drop.
- Align the magnified image of the scale of the second dissection strip across the horizontal diameter of the field of view of the microscope.

11. Draw in the magnified scale on the horizontal line of the first circle on the Ovule and Embryo Student Data Sheet. Be as accurate as possible in the spacing between the scale marks.

- Draw a scale bar at the top or bottom of the circle representing the distance of 1 mm or some fraction (0.5, 0.25, 0.1) of the magnified millimeter scaling. Indicate the distance represented by the bar on the drawing.

12. Observe the embryo and accurately draw it to scale within the same circle as the scale bar.

13. Identify and record the stage of embryo development (globular, heart, torpedo, etc.).

- Either from the drawing or directly, measure and record the length of the embryo, excluding the suspensor. Record the magnification of your microscope.

14. Calculate the magnification of the drawing using the following method:

- Measure and record the actual distance in millimeters between the two ends of the scale bar in the circle of the drawing of the embryo (e.g., 21 mm).
- Divide this measurement by the distance in millimeters represented by the scale bar in the circle to give the magnification of the scale bar and drawing (e.g., 21 mm/0.5 mm = 42X).

15. Dissect ovules from pods of different dap making drawings and length measurements of the difference stages of development, using the remaining circles on the Ovule and Embryo Student Data Sheet. If students have "spare" ovules at one developmental stage, they can share them with other students or exchange them for ovules at different stages of development.

**Suggested dissection times include 6, 9, 12 and 17 to 20 dap.** If dissections are made in a potassium iodide staining solution, note the presence or absence of starch in the ovule at different stages.

### Concluding Activities and Questions

In completing Activity 6, students will have taken their AstroPlants through a complete life cycle, from sowing the seed on Day 0 to harvesting the seed for the next generation. Analyze the data taken on the Ovule and Embryo Student Data Sheets. Have students consider the following:

- Students as a group or as a class may construct a developmental graph or chart depicting the day on the x-axis and the length of the embryo, size and stages on the y-axis, similar to what has been done for the growth of AstroPlants on page 11.
- Students may use the embryo lengths of various developmental stages as a quantitative indicator of development (page 64).
- How much does the embryo enlarge from the time it is a globular until it is mature?
- What are the relative sizes of the various stages in embryogenesis? With what will you compare those sizes?
- In what stages of embryogenesis is the embryo enlarging most rapidly? What is your evidence?
- What becomes of the endosperm? Is there any stage in embryogenesis at which starch is not present in the ovule?

### Extension

The embryo dissection activity can also be performed using pods that have been harvested and "fixed" in an acetic alcohol fixative on specified days after pollination. Fixed pods can be stored for future use. See page 98 for an acetic alcohol fixative recipe and safety information.

#### *Practice makes perfect . . . embryos!*

Embryo dissection can be challenging for students, especially when the embryos are at the early stages of development. Prior to beginning the dissection of your experimental embryos, you and your students should practice dissecting embryos at different stages.

Have students plant several film can wick pots of AstroPlants, timed to be different ages the day or two before your class begins its experimental dissections. Pollinate these plants well: the more pods, the more practice!



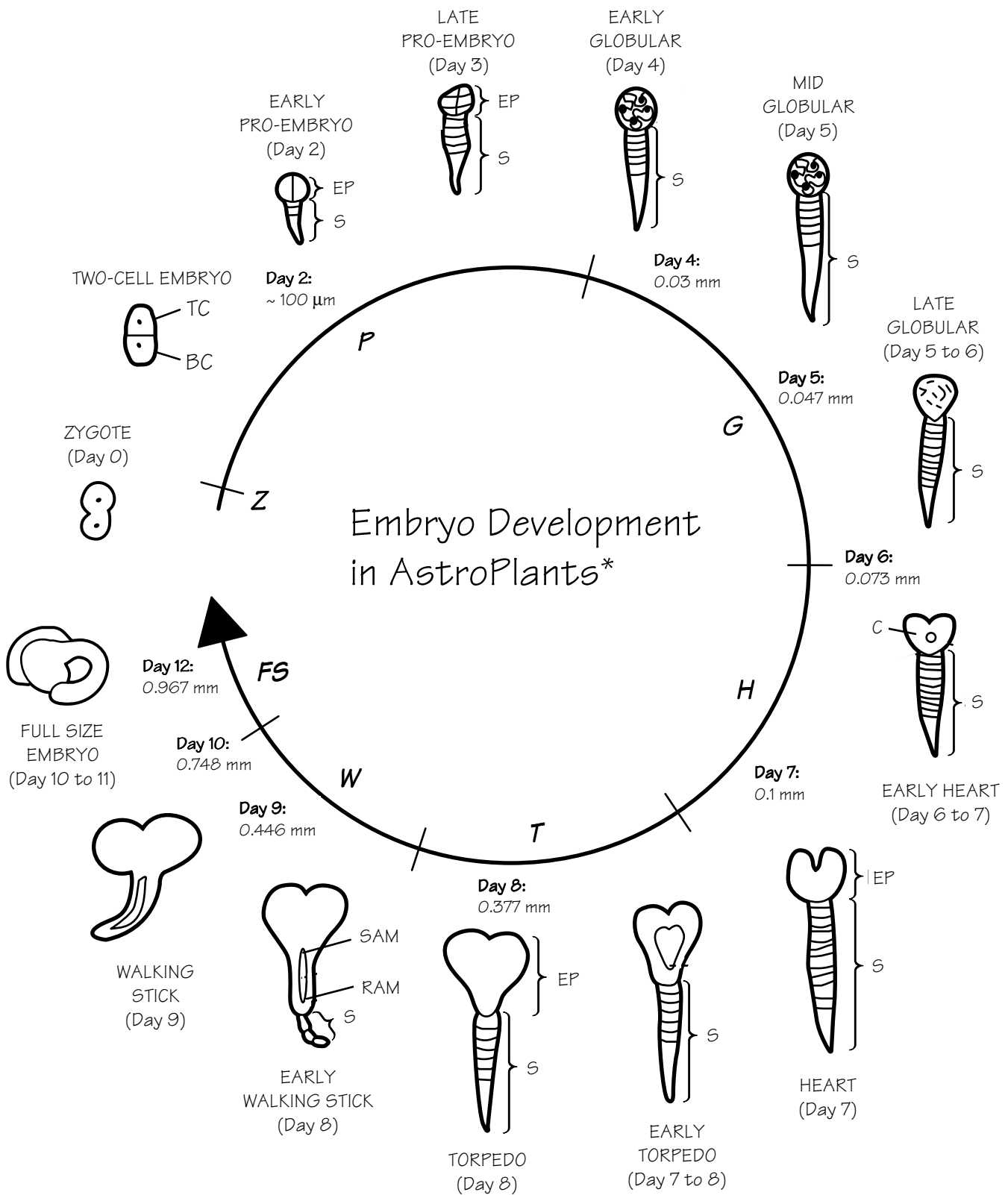

**KEY**

BC = basal cell	C = cotyledon	EP = embryo proper	RAM = root apical meristem
SAM = shoot apical meristem	S = suspensor	TC = terminal cell	
Z = zygote	P = pro-embryo	G = globular	H = heart
		T = torpedo	W = walking stick
			FS = full size

\*embryos not drawn to scale; sizes are samples, measured on embryos from wild type plants (AstroPlants embryos may be slightly smaller)

# Ovule and Embryo Student Data Sheet

Student Name \_\_\_\_\_

Date \_\_\_\_\_

*dap* \_\_\_\_\_  
scale bar length \_\_\_\_\_  
ovule length \_\_\_\_\_  
stage letter \_\_\_\_\_  
embryo length \_\_\_\_\_  
magnification  
of drawing \_\_\_\_\_  
magnification  
of microscope \_\_\_\_\_

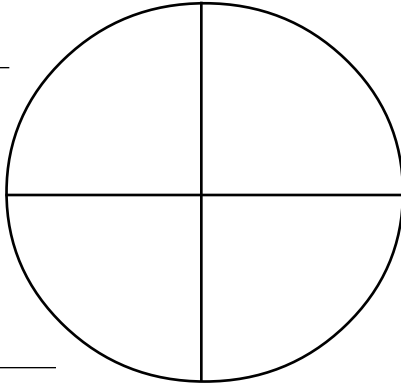

*dap* \_\_\_\_\_  
scale bar length \_\_\_\_\_  
ovule length \_\_\_\_\_  
stage letter \_\_\_\_\_  
embryo length \_\_\_\_\_  
magnification  
of drawing \_\_\_\_\_  
magnification  
of microscope \_\_\_\_\_

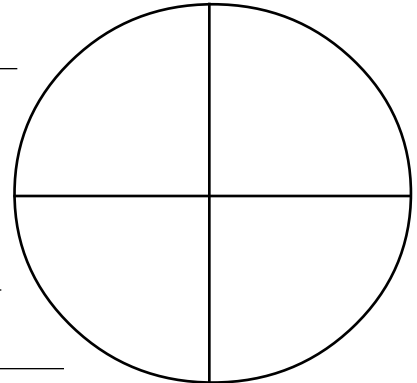

*dap* \_\_\_\_\_  
scale bar length \_\_\_\_\_  
ovule length \_\_\_\_\_  
stage letter \_\_\_\_\_  
embryo length \_\_\_\_\_  
magnification  
of drawing \_\_\_\_\_  
magnification  
of microscope \_\_\_\_\_

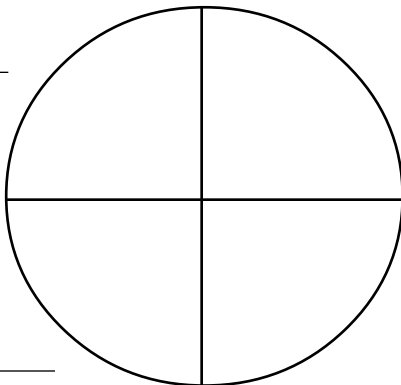

*dap* \_\_\_\_\_  
scale bar length \_\_\_\_\_  
ovule length \_\_\_\_\_  
stage letter \_\_\_\_\_  
embryo length \_\_\_\_\_  
magnification  
of drawing \_\_\_\_\_  
magnification  
of microscope \_\_\_\_\_

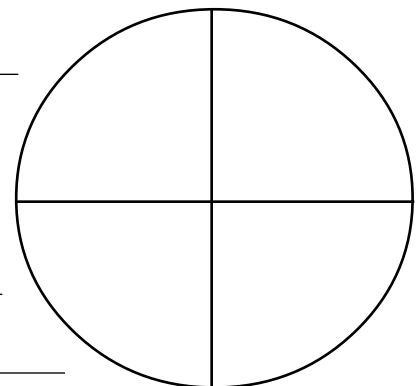

# Germination

## Concepts

Germination is the awakening of a seed (embryo) from a resting state. It involves the harnessing of energy stored within the seed and is activated by components in the environment.

In the metaphor of the mission, the seed is pointed in the correct position and ready for launch. Germination, like launch, involves the bringing together of essential chemicals, hydrogen and oxygen, to generate energy that will be directed toward expanding and propelling the two growing points of the germinating seed outward (upward and downward if guided properly).

## Questions

- What are the main components of the environment necessary for germination?
- How does the germinating seed go about harnessing its stored energy and using the environment?
- How does a germinating seed 'know' which way to grow?
- What developmental events enable the emerging plant to shift its dependency from stored energy to the energy from light?

## Background

*Germination* is the beginning of growth of a plant from a previously dormant seed which contains the embryo. Germination begins when the seed takes up water (*imbibition*) and the seed coat cracks.

An embryonic root (*radicle*) emerges from the seed and develops root hairs that bring in water and nutrients. In AstroPlants, an embryonic stem (*hypocotyl*) elongates, pushing the seed leaves (*cotyledons*) upwards through the soil. As they emerge from the soil the cotyledons expand. The cotyledons serve as an energy source until true leaves form. These events happen on Days 1, 2 and 3 of the AstroPlants life cycle (see page 11). For germination to take place, water and oxygen are needed and the temperature must be suitable.

With germination water is the "on" switch. Water taken up by the dry seed hydrates the cytoplasm, activating enzymes, solubilizing substrates, loosening the structural fabric of walls and providing pressure that enlarges the cells, resulting in expansion and growth. Oxygen, another essential ingredient, combines

with hydrogen from the stored oil reserves in the embryonic seed leaves and fuels the metabolic combustion that powers life processes. Rapid development of the fine root hair cells vastly increases the surface area of the root, facilitating the uptake of water that drives the elongation of the hypocotyl, which pushes the seed leaves and shoot meristem upward through the soil.

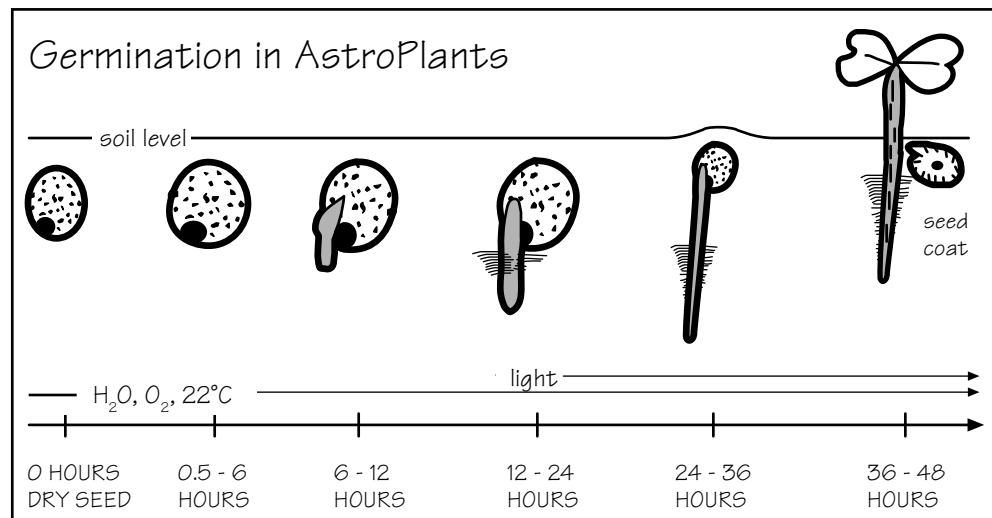

On Earth, orientation during germination is provided by gravity. Roots respond positively to gravity by growing downward (*positive gravitropism*), while shoots respond negatively by growing upward (*negative gravitropism*). Prior to emerging from the soil into the light, the germinating brassica seedling is dependent on the energy reserves stored in the seed leaves. Seeds of other plant species may also store carbohydrates, starch (cereals) or protein (legumes, beans).

Upon emergence from the soil and triggered by the light, the cotyledons expand, casting off the protective seed coat, turn green and become photosynthetically active. At this point the "plant" becomes independent of the stored reserves and dependent on the energy of light. Launch has been successful! The solar panels (cotyledons) have been deployed. The future success of the mission depends on keeping the panels oriented and operational to gather light energy which is converted through photosynthesis to chemical energy for growth, flowering and reproduction.

The following activity will provide students with insight into the various stages of germination and give them an introduction to the phenomena associated with orientation. Remember, one of the big questions about the microgravity environment is: how will plants know which way to grow?

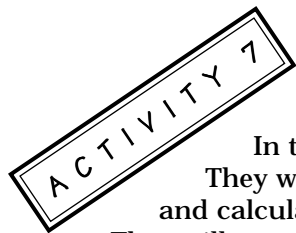

## Getting Acquainted with a Seed

### Introduction

In this activity students become acquainted with the anatomy and biology of seeds.

They will use lenses and scales and make drawings to scale. Students will measure and calculate magnifications and they will begin to understand relationships among these.

They will organize and summarize their data and, as they do so, they will be developing the understanding and skills needed to undertake more detailed investigations on the reproduction of AstroPlants in space.

### Questions

- On a seed, which way is up?
- Does a seed “know” which way to grow? If so, *how* does a seed “know” which way to grow?
- When planting a seed, is there a best way to orient the seed?
- In microgravity is there a best way to orient the seed?

### Time Frame

This activity will take two or more 50 minute class periods. During the first period students will make a dissection strip and become familiar with its use in conjunction with magnifying lenses and microscopes for observing, measuring and recording data from seeds. The dissection, organization, analysis and discussion of student and class data could take another period. Further periods can be spent graphing and statistically analyzing data.

### Learning Objectives

This activity is designed to strengthen students' observational and quantitative skills. In participating in this activity students will:

- learn to use magnifying lenses, microscopes and dissecting tools for detailed observation;
- measure scales with rulers;
- draw to scale, with accuracy and precision to understand scale and magnification;
- learn features of the external anatomy of seeds that are associated with certain features of the internal anatomy of seeds; and
- estimate the amount of water required to be taken up by seeds in order to initiate germination.

## Materials



- two brassica seeds or any other similar-sized seed (e.g., turnip, alfalfa or lettuce), one set that has been presoaked in water for 1 to 3 hours, then placed on moist paper towel
- two pinto bean seeds, one dry and one presoaked for 4 to 12 hours
- 5X hand lens
- dissecting microscope with 20 to 40X magnification
- two dissection drawing cards with two 50 mm circles (page 99)
- two dissection strip (page 23)
- fine dissection needles, e.g., tuberculin syringes with #23 or #25 needle, or #8 sewing needle
- forceps to handle seed
- pencil with eraser for sketches
- Student Seed Data Sheet (page 72)
- Class Seed Data Sheet (page 73)

## Procedure: Comparing Size

1. Have students place a pinto bean and a brassica seed (or other similar sized seed) on the sticky tape on a dissection strip. Roll them around until they are over the millimeter scale oriented with the long axis along the scale.
2. Measure to the nearest half or quarter millimeter the length of each kind of seed and record each estimate as a decimal (e.g., 6.25 mm). Record the measurements in Row 1 on the Student Seed Data Sheet (SSDS), with the brassica in Column 1 and pinto bean in Column 2. Enter these data in Rows 1 and 2 of the Class Seed Data Sheet under the appropriate student column number.
  - Calculate what fraction of the pinto bean length is the brassica seed length. Enter the result on SSDS, Row 2, Column 1 as a fraction.
  - Calculate how many times longer the pinto bean is than the brassica seed. Enter the result on SSDS, Row 2, Column 2 as a decimal.
  - Proceed as if both seeds are spherical with diameters equivalent to their lengths and calculate their volumes. Enter the volumes on SSDS, Row 3, Columns 1 and 2.
  - Express the volume of the brassica seed as a decimal of the volume of the bean on SSDS, Row 4, Column 1. How many times larger in volume is the pinto bean? Enter this number on SSDS, Row 4, Column 2.
3. Place a film can magnifier or hand lens over the seeds and the scale.
  - Observe and re-measure the magnified images of the length of each seed, estimating to the nearest quarter millimeter.
  - Record the lengths on the SSDS under Row 5, Columns 1 and 2 for magnified measures. Also, record these lengths in Rows 3 and 4 of the Class Seed Data Sheet under the appropriate student column number. Note on the SSDS, Row 5, the magnification of the viewing lens.
  - With the aid of a magnifier, were students able to measure the seed more accurately? Describe in writing why you were or were not.

"From the leaves and downs,  
and beards of plants,  
we come at last to the seeds;  
and here indeed seems to be  
the cabinet of nature,  
wherein are laid up its jewels..."

- Robert Hooke, 1667



**Procedure: Orientation of the Seed – Which Way is Up?**

1. While each seed is on the dissection strip, roll it around with a needle or pencil point and observe its shape and features.

2. Can students determine which way is up on the seed?  
For this a *point of view* is needed.

- On Earth *bottom* is usually directed down or in the direction of the gravitational force (toward the center of the Earth). *Up* is opposite.

- *Front* can be arbitrarily determined as that view which presents most visible detail. Can students find the front of their seeds?

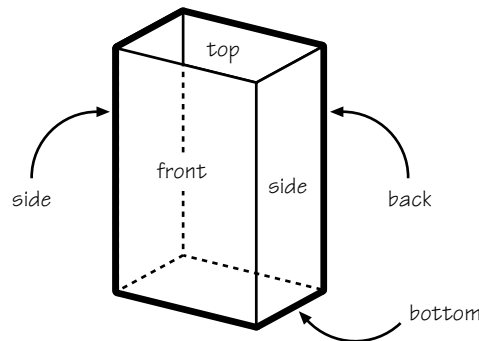

3. On the pinto bean, a distinctive oval light area on the seed coat will be observed. This is the *hilum* and is the scar where the developing seed was attached through the *funiculus* (like an umbilical cord) to the maternal tissue of the carpel or ovary. If the hilum is facing you, this is front.

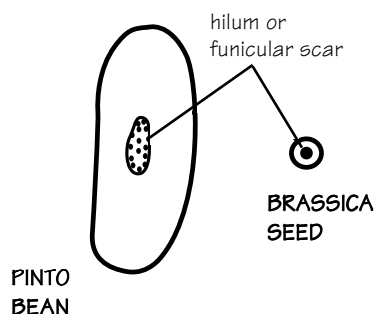

4. Now roll the brassica seed around on the tape. With the aid of a magnifier, a darker circular area with a small lighter area in it will be seen. This is the remains of the funicular attachment.

5. Looking at the front view of the seeds, can you tell which direction is up and which is down?

- To answer this question students will need to observe and record details of their seeds under greater magnification using the dissection strip, a microscope and a dissection card for drawing to scale, estimating object sizes and calculating the magnification of the drawing.

**Procedure: Drawing to Scale – Measuring and Magnification**

1. With the seeds still on the dissection strip and using a hand lens or film can magnifier on the dissection strip, align the millimeter scale across the horizontal diameter of the circular field of view of the lens.

- Encourage students to relax, have them keep both eyes open, but training their eye and brain to concentrate on the scale and the seeds. This will take some practice.

2. Using the left circle on the first dissection card, with a sharp pencil lightly sketch in the magnified scale on the horizontal center line of the circle. Encourage students to be as accurate as possible in drawing and spacing the millimeter scale marks (see page 74 for a sample dissection card).

- Now near the bottom of the circle draw a line or *scale bar* that is the length or some fraction of the length between two magnified millimeter scale marks (e.g., 10 mm, 1 mm, 0.5 mm, etc.). Indicate on the scale bar and on the card the length represented by the scale bar.

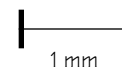

3. Students should make an accurate drawing to scale of the front view of the brassica seed, recording as much detail of the hilum and surrounding area as they can observe.

- On the dissection card note:
  - the object (e.g., the pinto bean)
  - the magnification of the lens (e.g., 5X, 10X, etc.)
  - the length represented by the scale bar (e.g., 1 mm, 0.5 mm, 0.25 mm, etc.)
  - the actual length of the scale bar in millimeters
  - an estimate of the length of the seed in decimal fractions, and
  - a calculation of the magnification of the drawing from the scale bar measures.

4. Repeat the same procedure with the pinto bean on a second dissection card.

5. Now with the same seeds, place the strip under a dissecting microscope or lens with magnification between 10X and 40X.

- On the second circle of each dissection card, repeat the accurate drawing of the magnified millimeter scale and seeds and note how enlarged the scale marks have become.

- In estimating the dimensions of the seeds, measure from the centers of the scale marks.

- At the higher magnification, not all of the pinto bean will fit into the field of view. In this case, just draw to scale the details of the hilum area, observing the location of the *micropyle*, a minute hole in a depression at one end of the hilum and opposite the end with two small raised pear-shaped structures.

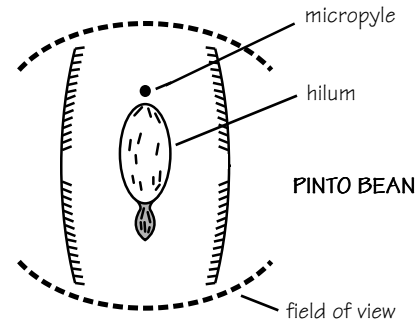

The micropyle is the hole in the ovule integuments through which the pollen tube passes on its way to double fertilization of the egg and polar nuclei (see the illustration on page 53).

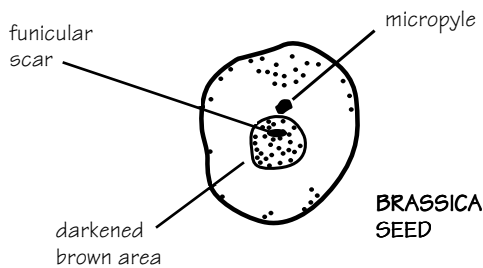

The micropyle is also the weakest area in the seed coat, or *testa*, which splits under pressure from the emerging root tip.

In brassica seeds, the micropyle is less conspicuous than in the bean, but appears as a minute raised area adjacent to the darkened circular area of funicular attachment.

6. Still using the higher magnification, students should complete the drawings of the scales and seeds in the right-hand circles of the two dissection cards.

- Students should calculate the magnification of their drawings.
- Students should enter the estimated length of their brassica seed measured from their drawing at the high power magnification on the Student Seed Data Sheet, Row 6, Column 1, indicating the magnification of the lens used, and on the Class Seed Data Sheet, Row 5.

**Procedure: On the Front View – Which Way is Up?**

1. Returning to the question of which way on the front view of the seed is up, take a pinto bean and a brassica seed that have been soaking in water for one to four hours. Dry off the excess water and place them on the dissection strip next to the dry seeds that have been measured.
2. Observe, measure and record the length of each soaked seed on the Student Seed Data Sheet, Row 7, and on the Class Seed Data Sheet, Rows 6 and 7. Then, as with the dry seeds, calculate the volumes and enter them in SSDS, Row 8, Columns 1 and 2.
3. Calculate the average volume increase of the brassica seed upon soaking. Enter this calculation in the SSDS, Row 9, Column 1. Repeat for the pinto bean and enter the calculation in the SSDS, Row 9, Column 2.
  - What causes the increase in seed volume? Is the increase in seed volume due entirely to water uptake (*imbibition*)? How can this question be tested?
4. Under magnification examine the front views of the soaked seeds, comparing them with the drawings of the dry seeds. Has anything changed? Can the hilum and micropyle still be seen?
5. Keep the location of the micropyle of the soaked pinto bean in view. With a sharp dissection needle cut through the testa around the hilum, peeling back the seed coat to expose the white or pale cream embryo. As this is done students will see the rounded tip of the embryonic root pointing towards the micropyle. Make a front view drawing of the embryo in the orientation with root tip pointing down.

**Concluding Activities and Questions**

In completing Activity 7, students will have made detailed observations of seeds which will provide them with further insight into plant biology and prepare them for further experimentation, including Activity 8, "Launching the Seed." If available, use data analysis software or a calculator to create graphical and statistical summaries of student and class data. Have students consider the following:

- How much variation was measured among the lengths of the pinto beans? Or of the brassica seeds? Is the variation distributed normally?
- Does the measurement of data differ when gathered from the unaided eye, with the assistance of a magnifier or from a drawing? How do measurement data differ when gathered by each method?

# Student Seed Data Sheet

Date \_\_\_\_\_

Student Name \_\_\_\_\_

## Seed Types:

Column 1: brassica or other similar-sized seed

Column 2: pinto bean

Row	Character/Activity	Column 1	Column 2
1	Length of dry brassica seed as measured by eye (mm)		Length of dry pinto bean as measured by eye (mm)
2	Ratio of brassica seed length to pinto bean length (fraction)		Ratio of pinto bean length to brassica seed length (decimal)
3	Brassica seed volume, assuming seed is spherical (mm <sup>3</sup> )		Pinto bean volume, assuming bean is spherical (mm <sup>3</sup> )
4	Ratio of brassica seed volume to pinto bean volume (decimal)		Ratio of pinto bean volume to brassica seed volume (decimal)
5	Length of dry brassica seed as measured with ___ X lens (mm)		Length of pinto bean as measured with ___ X lens (mm)
6	Length of dry brassica seed from ___ X drawing (mm)		
7	Length of soaked brassica seed (mm)		Length of soaked pinto bean (mm)
8	Volume of soaked brassica seed, assuming seed is spherical (mm <sup>3</sup> )		Volume of soaked pinto bean, assuming seed is spherical (mm <sup>3</sup> )
9	Increase in brassica seed volume caused by soaking (percentage)		Increase in pinto bean volume caused by soaking (percentage)

# Class Seed Data Sheet

Date \_\_\_\_\_  
 Teacher Name \_\_\_\_\_

Row	Measurement*	Student Data**																Statistics			
		1	2	3	4	5	6	7	8	9	10	11	12	13	14	15	16	n	r	x	s
1	Length of dry brassica seed (SSDS Row 1, Column 1)																				
2	Length of dry pinto bean (SSDS Row 1, Column 2)																				
3	Length of dry brassica seed measured with ___ X lens (SSDS Row 5, column 1)																				
4	Length of dry pinto bean measured with ___ X lens (SSDS Row 5, Column 2)																				
5	Length of dry brassica seed from ___ X drawing (SSDS Row 6, Column 1)																				
6	Length of soaked brassica seed (SSDS Row 7, Col. 1)																				
7	Length of soaked pinto bean (SSDS Row 7, Col. 2)																				

\* these measurements were recorded on the Student Seed Data Sheet in the Row and Column indicated, and should be transferred to the appropriate Student Data columns  
 \*\* this Class Seed Data Sheet will hold data from up to 16 students

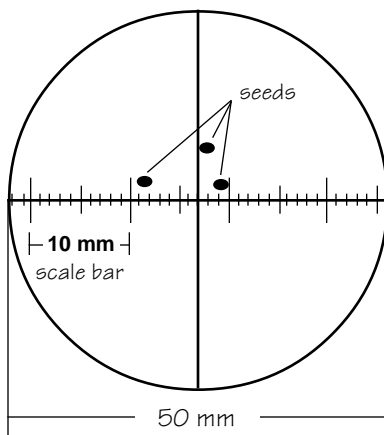
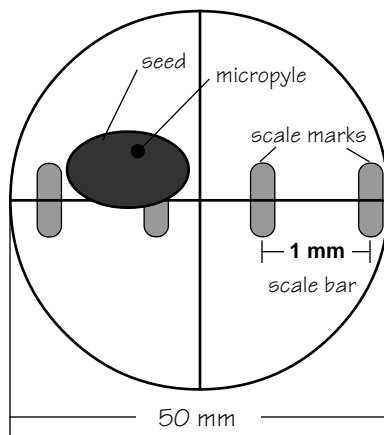
<b>Dissection Card</b>	
Name <u>Willy Doit</u> Date <u>8 - 6 - 96</u>	
<ol style="list-style-type: none"> <li>1. Draw a magnified scale on the horizontal axis of the field.</li> <li>2. Accurately draw scale bar indicating length.</li> <li>3. Draw the object in view to scale.</li> </ol>	<div style="border: 1px solid black; padding: 5px; margin-bottom: 5px;">complete items below:</div> magnification of lens: <u>5</u> X  length represented by scale bar: <u>10</u> mm  actual length of scale bar: <u>14</u> mm  estimated length of object: <u>1.5</u> mm  calculated magnification of drawing: = $\frac{14}{10}$ = <u>1.4</u> X
Object is: <u>brassica seeds</u>	Object is: <u>brassica seed</u>
	
<div style="border: 1px solid black; padding: 5px; margin-bottom: 5px;">complete items below:</div> magnification of lens: <u>30</u> X  length represented by scale bar: <u>1</u> mm  actual length of scale bar: <u>14</u> mm  estimated length of object: <u>1.6</u> mm  calculated magnification of drawing: = $\frac{14}{1}$ = <u>14</u> X	

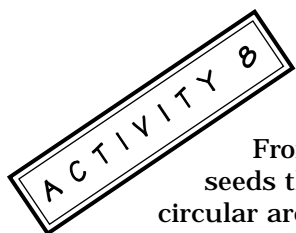

## Launching the Seed

### Introduction

From the activity "Getting Acquainted with a Seed," students found that on brassica seeds the tip of the embryonic root points down toward the micropyle, near a darkened circular area on the seed coat associated with the attachment of the seed to the maternal ovary by way of the funiculus. Follow the steps below to begin to explore the interaction of germination and orientation.

**Question:** For a brassica or other seed, which way is down? Or up?

**Sample Hypothesis:** The dark spot near the micropyle is down - brown is down.

**Sample Null Hypothesis:** Brown is up.

### Design:

- Germinate seeds oriented in different directions. Observe and record initial and later direction of root emergence from seed. Alter orientation of seedlings, predict, observe and record responses.
- Observations are recorded on the "Launching the Seed Student Sketch Sheet," (page 77).

- **Design Tip:** You may want to begin this activity on a Monday, so that your germination will occur during the week when students can make observations. Alternatively, students may set it up and observe it at home.

### Time Frame

Students will be able to construct their seed germinator and place their seeds within one 50 minute class period. This activity is designed for the student to observe their germinators over a two to three day period. Data are collected as drawings and a written discussion. Time for observations should be five to ten minutes on each of three consecutive days.

### Learning Objectives

In participating in this activity students will:

- determine whether their understanding of seed anatomy from Activity 7 is correct and their hypothesis regarding seed orientation is verified, namely that the micropyle is the down orientation in brassica seeds; and
- understand that plant roots reorient in the direction of their growth to conform with the direction of the gravitational force.

### Materials

- two soda bottle caps (film can lids will also work)
- kitchen plastic wrap
- paper toweling
- four brassica or other similar-sized seeds (lettuce, turnip, or alfalfa)
- forceps for handling seed
- hand lens
- elastic band

### Procedure

1. Cut two layers of paper towel into circles that will fit into the bottom of a soda bottle cap.
2. Place the towel in the cap and moisten it with water. Pour off any excess water.
3. Orient the four seeds in north-south-east-west positions on the moist towel surface, making sure that the brown micropyle area (spot) is pointing toward the center of the cap (Figure 1).
4. Make a mark on the bottle cap that indicates the direction of north, or up.
5. Cover the open cap with plastic wrap and secure the wrap with an elastic band. Trim off excess wrap with scissors.
6. Position the "bottle cap seed germinator" so the seeds are in a vertical orientation by standing it in a second bottle cap (Figure 2, page 76).
7. Make a drawing of the seeds in the bottle cap germinator, including the orientation of the brown micropylar area toward the center of the circle. Use the "Circle 1" on the Launching the Seed Student Sketch Sheet.

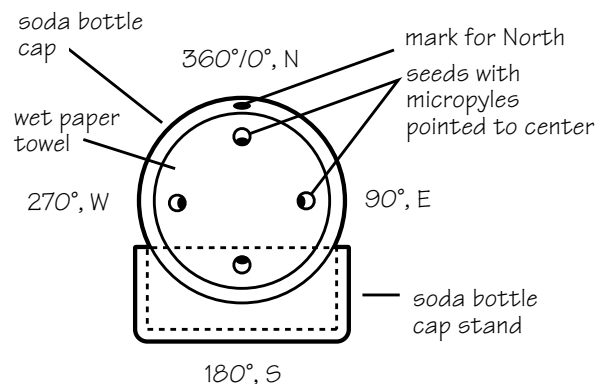

Figure 1: Front view of bottle cap seed germinator.

8. If students carry their bottle cap seed germinator home with them, they can **observe it every few hours**. Be sure to keep it in the vertical position with the proper north-south-east-west orientation.

9. When the roots begin to emerge, record the direction of the emerging root from each seed with a second drawing on the Sketch Sheet (Circle 2). You may wish to use a hand lens.

10. Continue to observe the germinating seeds being sure that the paper towel is kept moist. Note the appearance of the fine, fuzzy root hairs and the extension of the hypocotyl.

11. **After 24 to 48 hours**, make a third drawing depicting the direction of the roots and hypocotyl and illustrating the root hairs, cotyledons and seed coat (Circle 3).

12. Then reorient your bottle cap seed germinator in some way that will give you more information on seed orientation. Make another drawing that predicts how the seedlings will look after 12 or 24 hours in this new orientation (Circle 4). Observe them from time to time – do you notice anything happening?

14. **Twelve or 24 hours** after reorientation, draw the seedlings on the Sketch Sheet (Circle 5). Has anything changed? Compare the outcome of the orientation with what you predicted in your last drawing.

15. Have students write about what they have learned on the Sketch Sheet.

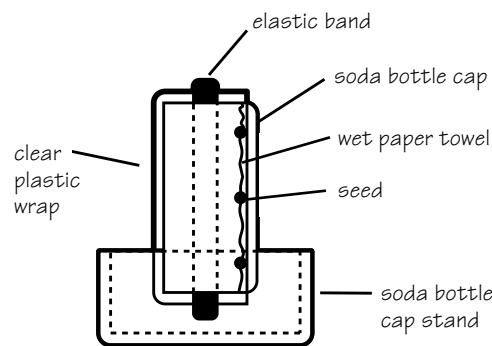

Figure 2: Side view of bottle cap seed germinator.

### Concluding Activities and Questions

In this activity students will have observed the effects of the Earth's gravity in reorienting the direction of roots in the direction of the gravitational force. They will also have observed that shoots orient against the direction of the gravitational force, bending and growing upward. This should raise a discussion around the questions:

- In microgravity which direction will roots and shoots grow?
- Is there a guiding force for root growth in the absence of gravity? Could you generate a hypothesis and experiment to carry this question farther? **Hint:** What would happen if you ran this experiment on a centrifuge?
- What might be the possible influence(s) of light in this experiment?



## Launching the Seed Student Sketch Sheet

**Circle 1:**

Sketch and label your bottle cap seed germinator at time of placement of seeds.

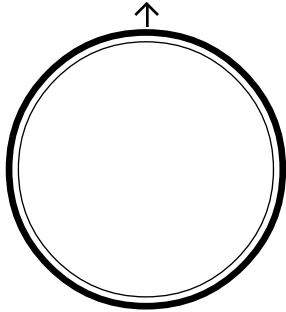

**Circle 2:**

Sketch and label your bottle cap seed germinator as the roots emerge from the seeds.

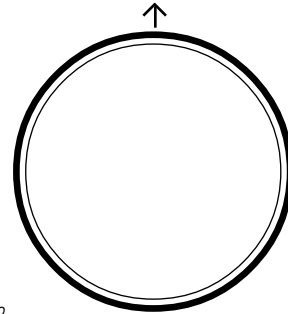

**Circle 3:**

Sketch and label your bottle cap seed germinator 24 to 48 hours after placement of seed.

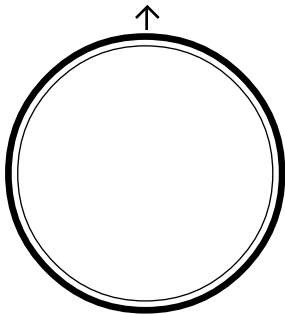

**Circle 4:**

Sketch and label your bottle cap seed germinator with your prediction of the effects of reorientation on your seedlings.

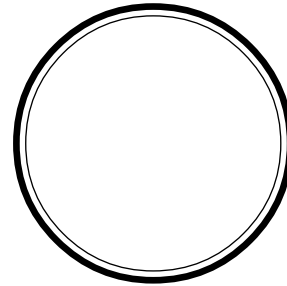

**Circle 5:**

Sketch and label your bottle cap seed germinator 12 or 24 hours after reorientation to compare with sketch in Circle 4.

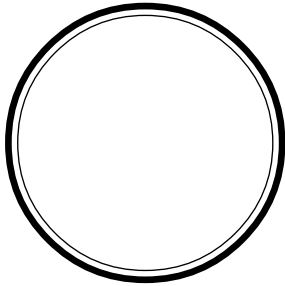

Write about what you have learned about germination and orientation.

---

---

---

---

---

# Orientation and Guidance

## Concepts

Rooted in the ground, plants, unlike most animals, are unable to relocate themselves in their environment from their fixed position. They are, however, capable of movement and of orienting themselves so as to optimize their capacity to access the environmental components essential to their life. Plants orient themselves to light and gravity through *tropism*. Plants use guidance systems which sense and respond to gravity (*gravitropism*) ensuring that roots anchor plants and access water and that shoots emerge into the light. Plants then use light to activate energy-capturing photosynthesis. Light also guides the development of leaf expansion (*photomorphogenesis*), stem bending and elongation (*phototropism*), and pigment production (chlorophyll and anthocyanin).

## Questions

- How does a seedling orient itself?
- How does a plant grow up?
- Why does the shoot grow up and the root down?

## Background

Plants like many other organisms, including humans, use both gravity and light to provide them with orientation and guidance in their environments. Rooted in the ground, plants are unable to move, but they are able to grow and bend toward or away from various stimuli in what is known as tropism. Roots exhibit positive gravitropism and shoots negative gravitropism. Whereas shoots are also positively phototropic (bend or grow toward a source of light), plants and humans rely heavily on gravity for orientation. We are especially aware of the verticality of our orientation as we lean forward or lift a heavy object.

The perception of the horizontal is mostly afforded us by light through sight. Our awareness of a horizon provides us with an essential sense of where we are in space. Just shut your eyes for a few moments and you come to realize how important 'horizontality' is to our orientation. The effects of the horizon on your sensory stability can be best experienced in movies of stunt aircraft flights or on roller coasters where the horizon is constantly changing. In the absence of sight, gravity and other sensory systems (sound, smell, touch) provide compensation in our orientation.

In the absence of light, plants rely on gravity for orientation. This leads to an interesting question for plant biologists: in the environment of microgravity and in the absence of light, are there other ways that a plant can become oriented? This and other questions will be under investigation in the CUE.

In the microgravity of the orbiting Space Shuttle, humans and plants do not perceive the force of Earth's gravity. Astronauts and cosmonauts orient visually on the many structures within the orbiter. In space, plants also must orient using light. Just how plants orient themselves to the light is still under intensive study by plant physiologists. Perhaps the best place to do such studies on phototropism is in the Space Shuttle and on the International Space Station, where the confounding influence of gravity as a guiding force is minimized.

"...[in plants] we know that there is always movement in progress, and its amplitude, or direction, or both, have only to be modified for the good of the plant in relation with internal or external stimuli."

- Charles Darwin,  
*The Power of Movement in Plants*, 1880

Seedlings of various plants, including AstroPlants, are excellent model organisms with which to investigate the influence of light on tropic bending. As presented in the section on light in "Understanding the Environment" (page 13), visible light includes a spectral range of wavelengths from 400 nanometers to about 750 nanometers, ranging from ultraviolet through blue, green, yellow, orange to red. Plants use different colored molecules to capture various wavelengths and use that energy for different functions, including photosynthesis, phototropism, and photomorphogenesis. Complex biochemical processes known as *signal transduction pathways* translate the energy transferred from light into various physical and physiological manifestations of growth and development.

The gravitropic response in plants is conditioned by a signal transduction pathway that is thought to be largely controlled by a group of growth promoting hormones called *auxins*, and by inhibitors of auxins. When a plant is turned on its side, auxins stimulate elongation in the cells on the lower side of the shoot, causing it to bend up (against gravity), but in the roots, cells on the upper side elongate causing the roots to grow down (with gravity).

In phototropism, an unequal distribution of auxins and inhibitors on the side of the plant away from the light stimulates cell enlargement on the "dark" side of the plant and results in the plant bending toward the light. Much has yet to be learned about how the force of gravity actually acts in the mechanism of tropism in plants.

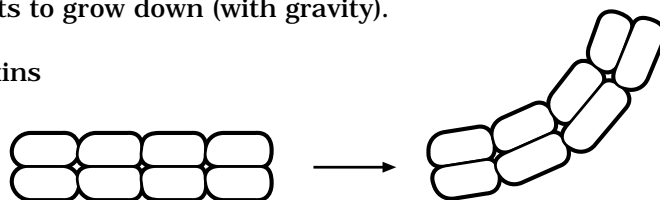

In Activity 8 on brassica seed germination (page 67), students will have observed the strong combined influences of gravity and light on seedling orientation and growth. However, the relative roles of each of these environmental factors on the direction of seed growth were not clearly defined. To approach this challenge, it will be necessary to separate experimentally the influences of each factor, light and gravity, on tropic responses. The following activities on gravitropism and phototropism will help students to understand how plants orient themselves and also how complex the interpretation of experiments into tropism can become.

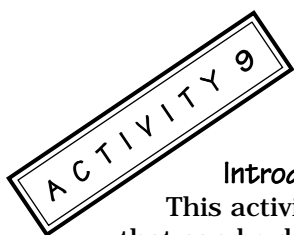

## Gravitropism: How do Plants "Know" Which Way to Grow?

### Introduction

This activity utilizes the "film can gravitropism chamber" in just one of many experiments that can be designed to answer a large number of questions that students may ask relating to the question: How do plants "know" which way to grow?

Begin by making the assumption that on Earth, in the absence of light, plants sense and respond (orient) to the gravitational force of 1 g (unit gravity).

**Question:** How responsive is the germinating seedling to Earth's gravity?

**Sample Hypothesis:** The AstroPlants seedling hypocotyl will respond rapidly and continuously, exhibiting negative gravitropism at least over a 72-hour period.

## Design

- Seeds are germinated in the dark over several days and are observed and measured for their directions of growth. At specified intervals of time, orientation is altered progressively by 90° of rotation through 360° of rotation.
- At each orientation, growth response is recorded on the Gravitropism Data Sheet (page 85).
- The experiment is designed so that it can be run either at home or in class.

## Time Frame

Construction of and placing seed within the film can gravitropism chamber will require one 50 minute class period. Observation and data taking will require time on the day of chamber construction and the two following days, approximately 15 minutes per day at specified intervals.

## Learning Objectives

In participating in this activity students will:

- learn that seedling hypocotyls (shoots) orient strongly in the direction opposite to the direction of the force of gravity;
- understand that the tropic response in seedlings is rapid and occurs in the absence of light;
- construct a simple piece of experimental equipment from low-cost materials; and
- develop spatial-temporal skills by predicting what seedling orientations will be in each of the four positions of the film can gravitropism chamber at each reorientation.

## Materials (per group of four students)

- 35 mm black film can with lid
- two extra film can lids
- clear double stick tape or double stick mounting tape
- white masking or lab tape, 2 cm wide
- four grid strips, 0.5 cm x 4 cm pieces cut from millimeter square graph paper photocopied onto overhead transparencies
- four wick strips, 1 cm x 4.5 cm strips of soft paper toweling
- one floral foam disc, 28 mm diameter, 2 to 4 mm thick
- four brassica or other medium-sized seeds (turnip, lettuce or alfalfa)
- water bottle
- forceps to handle seed
- ultrafine permanent black marker

## Preparation

- **Making grid strips:**
  - Photocopy millimeter square graph paper onto an overhead transparency sheet.
  - Cut the sheet along the lines to make strips with the dimensions 0.5 cm x 4 cm.
  - Grid strips can be reused after rinsing, soaking for 20 minutes in a 20% bleach solution, then rinsing again and drying on paper toweling.

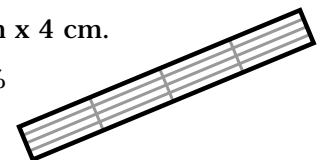

- **Making wick strips:**
  - Fold a square sheet of kitchen paper toweling to form an eight layered rectangle.
  - With scissors, trim end and folds to make a rectangle with the dimensions 4.5 cm x 10 to 12 cm.
  - Cut wick strips from the rectangle by cutting 1 cm strips.

- **Making germination strips:**

- Hold a wick strip with a grid strip aligned on top of it. Moisten the wick strip.

- As the wick strip becomes moist through capillary action, the grid strip will adhere to it through the adhesive forces of the water. Together the wick and grid strip make a germination strip.



- The wet germination strip will adhere to the inner wall of the film can gravitropism chamber.

- **Making plastic seed forceps:**

- Cut a strip 1 cm x 10 cm from a piece of the flat side of a heavy plastic food or detergent bottle.

- Bend the strip in half and crimp the fold lightly between your thumb and forefinger.

- With scissors, trim edges to points of desired taper and precise alignment.

- Place a triangle of electrical tape on the inner surface of one of the forceps tips by taping on a square and trimming of the excess tape with scissors. The tape will cushion the seeds and prevent them from slipping from the forceps.

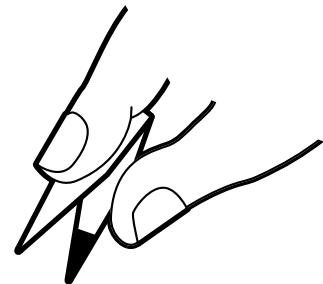
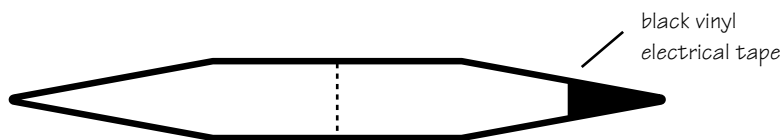

- **Making floral foam discs:**

- Prepare discs by cutting foam cylinders with a Fuji® brand "film can foam cylinder cutter" created by cutting off the bottom of a Fuji® film can and beveling the outside edge with a knife.

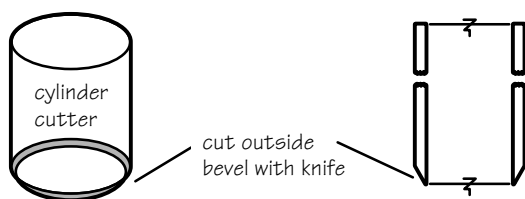

It is important to use clear Fuji® film cans for this step because the foam cylinders and foam discs will have a diameter of 28 mm required to fit inside the tropism chamber.

- Cut foam cylinders by carefully pressing the cylinder cutter completely through a dry floral foam block.

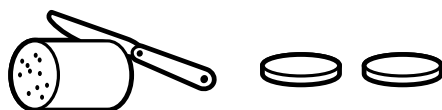
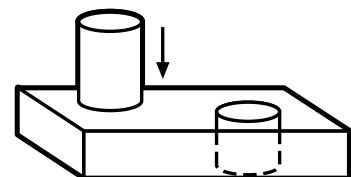

- With a flat knife slice discs of foam 2 to 4 mm thick from the cylinders.

**Procedure**

1. Each student or group of students should construct a **film can gravitropism chamber**.

- On each extra film can lid place a 3 cm strip of double stick tape and then attach the lids to the outside wall of the film can so that each lid is opposite the other.
- Mark the film can using an ultrafine tipped permanent marking pen to draw arrows on the film can lid and one of the mounted lids as in Figure 1 to indicate "FRONT".
- With the front facing you, stick a white label on the right side of the chamber and draw a compass on the label, marked with angles of 0°/360°, 90°, 180° and 270°, corresponding to north, south, east and west (Figure 2).
- As indicated in the right side view drawing of Figure 3 (page 83), put in arrows indicating a counterclockwise direction or rotation.

2. Place the floral foam disc in the bottom of the film can.

3. With a water bottle, add enough water to saturate the floral foam and just a little more free water in the bottom.

4. Dip the end of a germination strip into the bottom of the can, touching the water until it wicks up some of the free water.

- Align the germination strip vertically inside the film can, with grid strip against the inner wall and the wick strip overlapping it and adhering to the wall.

- You may tilt the film can to encourage the free water to ascend the wick strip and speed the adhesion of the wick to the wall.

5. Align the germination strip with the front orientation of the chamber. At this stage you may let the strip extend above the rim of the film can chamber.

6. Repeat the procedure with the other germination strips, aligning them to create four strips opposite each other aligned at 90 degree angles, as illustrated.

7. Now remove one strip pair from the chamber and with your finger or using seed forceps to pick up one seed, place it about 2 cm down the strip. The seed will adhere to the wet paper towel.

8. With a forceps or a pencil point align the seed so the micropyle points down (this hinges on what was learned in the Activities 7 and 8).

**Figure 1:** Front view of film can gravitropism chamber.

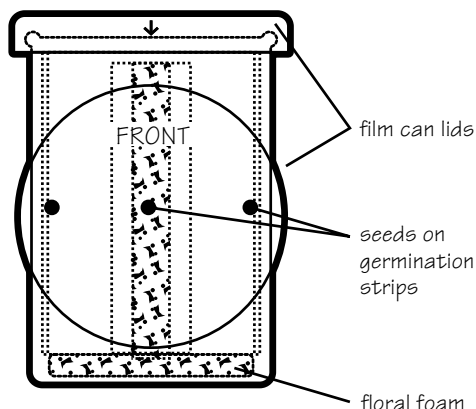

**Figure 2:** Side view of film can gravitropism chamber.

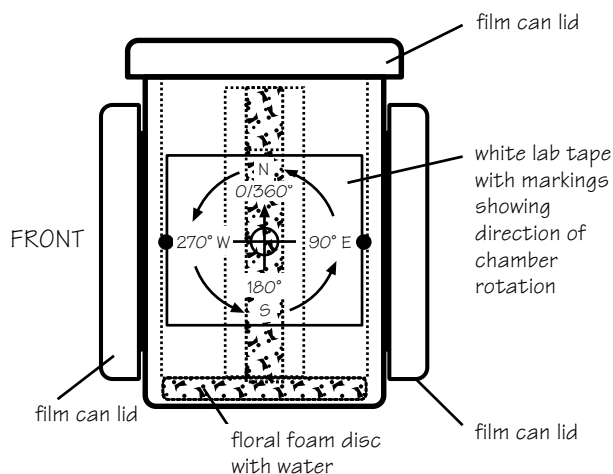

10. Replace the strip with seed to its original position in the can, but this time push the germination strip down so that the bottom of the wick strip connects with the wet floral foam disc and the top of the strip is below the rim of the film can chamber. *It is critical that the top is below the rim, or when the chamber is closed, the moisture from inside will "wick" out of the can.*

11. Repeat steps 8 to 10 until all four seeds are on the four wick strips in the chamber.

12. Make a final check on the amount of water in the bottom of the chamber.

- If there is excess free water, gently tip the chamber and let the extra water drip out, making sure not to wash off the seeds.

13. Gently place the film can lid on, sealing the chamber. Be sure that the arrow on the lid is aligned with the arrow on the front cap of the chamber.

- As indicated in Figure 3, each strip has a numbered position, 1 to 4: 1 is front, 3 is back, 2 is left and 4 is right.

14. Put a white tape label on the top lid of the film can with the following information recorded: your name, the date (e.g., 10-1-97), the time on a 24 hour clock (e.g., 13:00 hours), and the symbol "0°" indicating the initial orientation of the chamber (upright). Add the information from the chamber label into the first three columns on the Gravotropism Data Sheet. **Germination in the absence of light has begun at hour zero.**

15. Place the chamber in the upright, 0°/360° position, where a relatively uniform temperature between 22°C and 30°C can be maintained. Under your light bank is ideal.

16. **Be prepared to observe your chambers every 12 to 24 hours**, noting any elongation of the seedling hypocotyls.

- When the seed and seedlings are observed, keep the lid open only for as long as necessary.

- If a seedling has fallen off of its wick strip, it may be placed back gently, picking it up with a forceps. If a seedling's root is growing off of the wick strip, it can be gently pressed to the wick where its root hairs will attach firmly. If it looks like more water is needed, add a few drops to the foam disc.

17. Sometime **between 24 and 48 hours**, depending on the temperature, the seedling hypocotyls will be between 1 cm and 2 cm long. Make a drawing of the vertical seedling on each strip in the appropriate box in the first row of the Gravotropism Data Sheet. Record the date, time (on a 24 hour clock) and total cumulative hours from hour zero.

18. **At this time rotate the chamber by 90°.** As the chamber is rotated, think about the possible outcome of reorienting the four seedlings.

- What will the seedling on each strip look like after 12 to 24 hours? Students should make a drawing on the Gravotropism Data Sheet of how they predict each seedling will appear.

Figure 3: Film can gravitropism chamber, view from above.

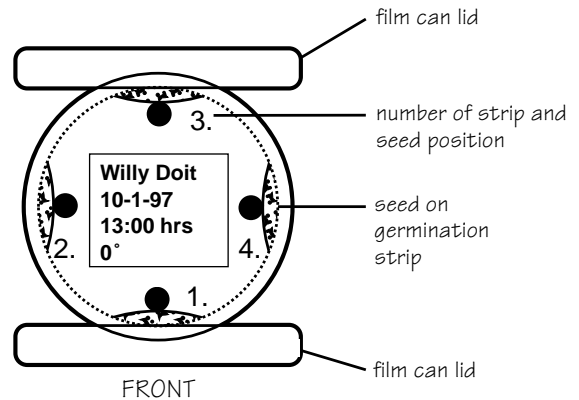

19. Record the date, time and total cumulative hours of your first 90° rotation on the Gravitropism Data Sheet, and each rotation thereafter.
20. **After 3 to 12 hours or 24 hours** (3 to 6 is best), observe the chamber. Mark the time and date on the Data Sheet and next to the predicted sketch, make a quick but accurate sketch of how the plant on each strip appears.
  - The chamber should then be rotated another 90° to the 180° position. A predictive drawing should be made on the Data Sheet and after 3 to 12 hours, repeat the cycle of observation, drawing and rotation. Be sure to record the date, time and total cumulative hours.
21. Continue rotating, observing and drawing until the chambers have completed 360° of rotation. Would students like to try to keep it going? Have them try it!
22. When the rotations have been finished carefully remove each strip with its seedling attached and make a final drawing.
  - Stretch out the seedling to straighten it, then accurately record the length of the hypocotyl from the hypocotyl from the cotyledon to the root hypocotyl junction above where the root hairs first appear.
  - On the Gravitropism Data Sheet, record the length of the hypocotyl in millimeters.

#### *Concluding Activities and Questions*

In this activity students will have observed the effects of gravity in orienting the growth of seedlings. Have students consider the following:

- Discuss the outcome of the experiment relative to the original hypothesis. Was the hypothesis verified? How strong is your evidence? Were you able to successfully predict how the seedlings would respond to successive reorientation of the chamber?
- What is the average length of the hypocotyls in your chamber after X hours of germinating in the dark? You fill in the X!
- How long is it possible for a hypocotyl to grow in the dark?
- Is there a limit to how long it would grow? If there is, what is it?
- When it is elongating, how is the hypocotyl actually growing longer? By what mechanism?
- Is there a limit to how much bending a hypocotyl can undergo?
- What would the orientation behavior of the seedlings be like in microgravity?



# Gravitropism Data Sheet

## Environment

Temperature Range: \_\_\_\_\_ °C  
 Average Daily Temperature of Growing Environment: \_\_\_\_\_ °C

Student Name 1 \_\_\_\_\_  
 Student Name 2 \_\_\_\_\_  
 Student Name 3 \_\_\_\_\_  
 Student Name 4 \_\_\_\_\_

		Germination Strip Position Number											
Date	Time (24 hr clock)	Total Hours	Hours from Last Rotation	Rotation Angle	1		2		3		4		
					predicted	observed	predicted	observed	predicted	observed	predicted	observed	
			0	0	X								
				90									
				180									
				270									
				360									
length of hypocotyl after _____ hours:													

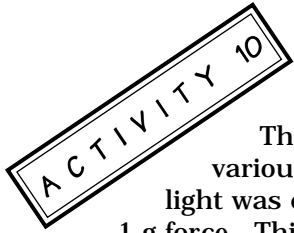

## Phototropism: Do Plants Prefer the Blues?

### Introduction

This activity will deal mainly with phototropism, illustrating how plants use various colors of light for different tasks. Unlike the gravitropism activity in which light was excluded, experiments in the classroom on Earth are done in the ever-present 1 g force. This fact can provide fascinating questions and design challenges for students.

### Question: A Phototropic Riddle

If you were a plant  
Or a plant were you,  
Which hue would you choose  
To tie your shoe?  
Is it red, green or blue?

### Sample Hypothesis:

My leaves are green,  
Could it be green?  
Or is it the red?  
I'll guess blue,  
And test if it's true.

### Design

- Give germinating seedlings a choice of red, green or blue light, each coming from a different direction, and see if they bend toward one color more than toward the others.

### Time Frame

Construction of the phototropism chamber will take approximately half of one 50 minute class period. The observational activities will take place over a period of 60 to 72 hours, with the actual time of observation and recording data requiring about 15 minutes at each interval.

### Learning Objectives

In participating in the activity students will:

- learn to construct their own experimental equipment from low-cost materials;
- learn to set up a simple experiment, make a prediction and observe results; and
- understand that blue wavelengths of visible light affect the bending of plants more than red or green, demonstrating the partitioning of various energy levels of light to different growth functions.

### Materials

- 35 mm black film can with lid
- one floral foam disc, 28 mm diameter and 2 to 4 mm thick
- three grid strips, 0.5 cm x 4 cm (page 49)
- three wick strips, 1 cm x 4.5 cm, made of soft paper toweling (page 49)
- three brassica or other medium-sized seeds (turnip, lettuce or alfalfa)
- water bottle
- forceps to handle seed
- hand-held hole punch
- 2 cm wide clear adhesive tape
- 2 cm wide black vinyl electrical tape
- three 1.5 cm squares, 1 each of red, green and blue transparent plastic mylar (Roscolux® films red #26, green #89 and blue #69, work well) or colored acetate from art stores or theatre departments

## Procedure

1. With a hand-held hole punch, make three windows about 1.5 cm from the rim of the black film can at approximately 120 degree intervals.
2. Use a 10 cm strip of clear adhesive tape to cover each window with a red, green and blue square.
3. As with the gravitropism chamber, place a floral foam disc in the chamber and wet it with water.
4. Set up three germination strips. The germination strips should be aligned vertically, each spaced between two windows (Figure 4). Be sure that the germination strips are below the chamber rim and that there is sufficient, but not excess, water in the floral foam disc.
5. Place a seed, oriented with micropyle down, 2 cm down on each strip.

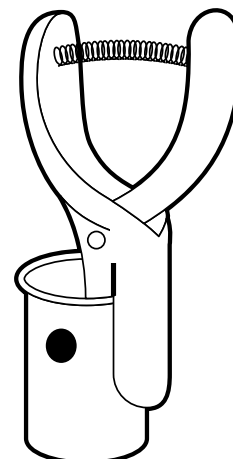

**Figure 4:** Film can phototropism chamber, view from above.

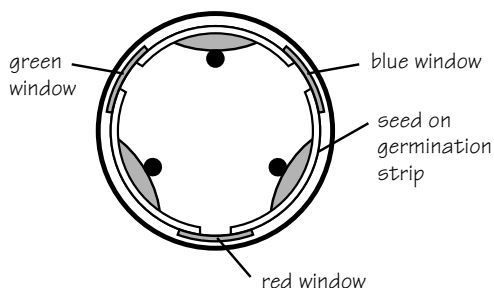

6. Snap the lid tightly onto the film can and place the phototropism chamber under a light bank where light will enter all three windows.
7. Make a top view drawing of your chamber, predicting how the plants will appear after 48 to 72 hours of germination.
8. **After 48 to 72 hours**, open the lid and indicate whether or not your prediction is to be accepted or rejected. As evidence, draw what you observe and compare it with your prediction.

## Concluding Activities and Questions

In this activity students will have observed the effects of light in orienting the growth of seedlings in the presence of gravity. Have students consider the following:

- Within the mix of colors making the white fluorescence of your plant lights, which color tells the plant which way is up? Is this the same for humans? Are you sure?
- What has been the influence of gravity on the phototropic response? How would the seedlings respond to light if this experiment were carried out in microgravity?
- What will happen to the seedlings if you darken the windows? What will happen if you darken only the blue window?
- Recently plant physiologists have isolated minute amounts of a yellow molecule called *flavochrome* that absorbs blue light and is active in the signal transduction pathway that transmits energy from the blue light to the bending response.

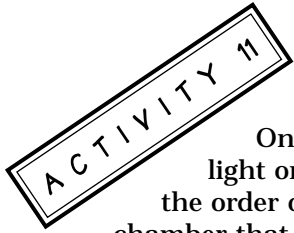

## Phototropism: How Little Light Will Bend a Seedling?

### Introduction

On Earth gravity is present in the quantity of 1 g (unit gravity). The quantity of light on the other hand can vary enormously from very large quantities of irradiance in the order of  $8000 \mu\text{Em}^{-2}\text{s}^{-1}$  in sunlight at noon to vanishingly small amounts. With the chamber that you and your students constructed in the phototropism activity, it is easy to investigate the effects of light quantity on bending of seedlings.

**Question:** How much light is needed to bend a seedling?

**Hypothesis:** You provide an amount. Then find out!

### Design

- Groups of students will use a set of film can phototropism chambers to vary the quantity (intensity and duration) of unidirectional light reaching seedlings and measure the responses over time. This experiment can be run at home to facilitate observation and data collection.
- Students will record observations and measurements on the Phototropism Data Sheet (page 91).

### Time Frame

Construction of the phototropism chamber will require approximately half of one 50 minute class period. The experiment will run 96 hours from the time seeds are placed in the chamber, with observations and measurements made at specific intervals. The time required for the measurements will be approximately 15 minutes at each interval.

### Learning Objectives

In participating in this activity students will:

- learn to construct their own experimental equipment from low-cost materials;
- apply simple geometry to the determination of the experimental variables of light quantity impacting a seedling; and
- learn to interpret complex interactions involving three variables, including three-dimensional graphing of data representing two independent variables (time and quantity of light) and one independent variable (angle of plant bending).

### Materials (per group of four students)

- four 35 mm black film cans with lids
- four floral foam discs, 28 mm diameter x 2 to 4 mm thick
- four grid strips, 0.5 cm x 4 cm (page 43)
- four wick strips, 1 cm x 4.5 cm, made of soft paper toweling (page 43)
- four brassica or other similar-sized seeds (turnip, lettuce or alfalfa)
- water bottle
- forceps to handle seed
- 2 cm wide clear adhesive tape
- 2 cm wide black vinyl electrical tape
- scissors
- four 1.5 cm squares of aluminum foil
- fine needles or pencil point for making holes in aluminum
- dissection strips (page 23)
- hand lens
- hand-held hole punch
- small plastic protractor or Tropism Response Measuring Card (page 90)

## Procedure

1. On each of four black film cans, use a hand-held hole punch to make a single hole of 6 mm diameter 1.5 cm from the rim and cover it with a clear strip of tape to make a window.
2. Taking a 1.5 cm square of aluminum foil, puncture the center of the foil with a very fine needle to make a circular hole (aperture of 1 mm diameter).
3. On a second square of foil, use the needle to puncture an aperture of about 2 mm diameter. On a third square puncture an aperture of 6 mm (Figure 5).
4. On a fourth foil square, make no aperture.
5. Measure the actual diameter of each aperture with the aid of a hand lens and ruler, estimating to a fraction of a millimeter, enter the diameter on the Phototropism Data Sheet. Calculate the area of each window and enter it on the data sheet.
6. With clear tape, mount each foil square over the window on a different film can phototropism chamber, so that now there are four chambers each with a window of differing aperture diameter (0 aperture, 1 mm, 2 mm and 6 mm).
7. Cover each of the windows with a 3 cm strip of black vinyl tape that has a 5 mm length folded back on itself to produce a tab so the tape can be easily removed.

Figure 5: Side view of tropism chamber, and aluminum foil squares with varying apertures.

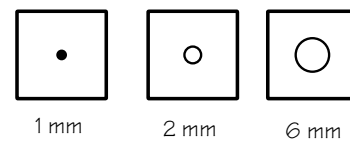
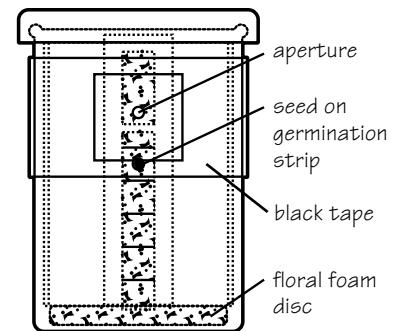
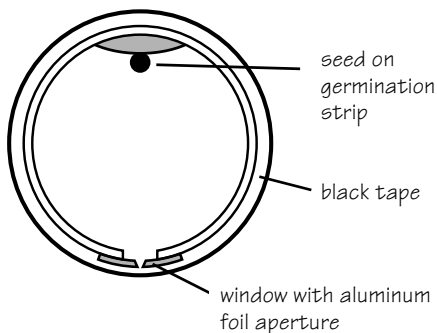

Figure 6: Film can phototropism chamber, view from above.



8. As in the gravitropism experiment, set up each chamber with a wet floral foam disc in the bottom but this time with a single germination strip with one seed located 2 cm down the strip.
9. Place the germination strip and seed opposite the window (Figure 6).
10. Set the chambers under the light bank with the windows in a position to receive light when the black tape window covers are removed.
11. **Let germination proceed in the dark for 36 to 48 hours**, then remove the window covers.
12. After removing the window covers, open the lid of each chamber and observe the orientation of the seedlings.
  - Remove each germ strip with its seedling. Lay each down on a Tropism Response Measuring Card as shown in Figure 7. Draw a line indicating the angle of bending from the vertical,  $\theta$ .
  - Carefully return the germination strip and the seedling to the original position in the chamber and replace the cap.

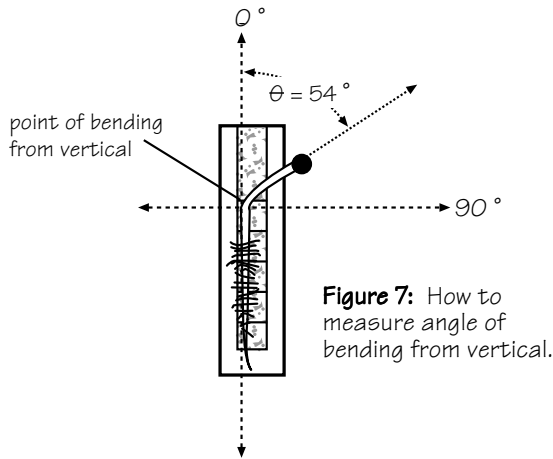

Figure 7: How to measure angle of bending from vertical.

13. With a protractor on the Tropism Response Measuring Card, determine the angle of bending for each seedling and enter the data on the Phototropism Data Sheet under  $T_1$ . Note the number of hours that have passed between the time the seeds were placed and the time of measurement.
14. Repeat steps 12 and 13 at each of three additional time intervals: **6, 24 and 48 hours after removing the window covers.** Record the high, low and average ambient temperatures during each time period.

### Concluding Activities and Questions

In this activity students will have observed the effects of light quantity on the growth and development of seedlings in the presence of gravity. Have students consider the following:

- From the Phototropism Data Sheet, plot a line graph with aperture diameter on the x-axis and degrees of plant response from the vertical ( $\theta$ ) on the y-axis, with each line representing a different time of exposure to light. On another graph, plot a second set of four lines with time of light exposure on the x-axis and the degrees of response from the vertical ( $\theta$ ) on the y-axis, with each line representing a different quantity of light. How do the two line graphs compare?
- This experiment represents two independent variables (time and quantity of light) and one dependent variable (angle of plant bending). These could be displayed graphically in a three-dimensional graph with axes x, y and z. Try plotting this graph; some computer software programs have this capability.
- Discuss the observed phototropic responses from the standpoint of the interaction of light direction and quantity (as aperture) as an opposing horizontal force at an angle of  $90^\circ$  to the constant vertical force of gravity.
- What do you think the response data from this experiment would look like if it were carried out in the microgravity of the Space Shuttle?

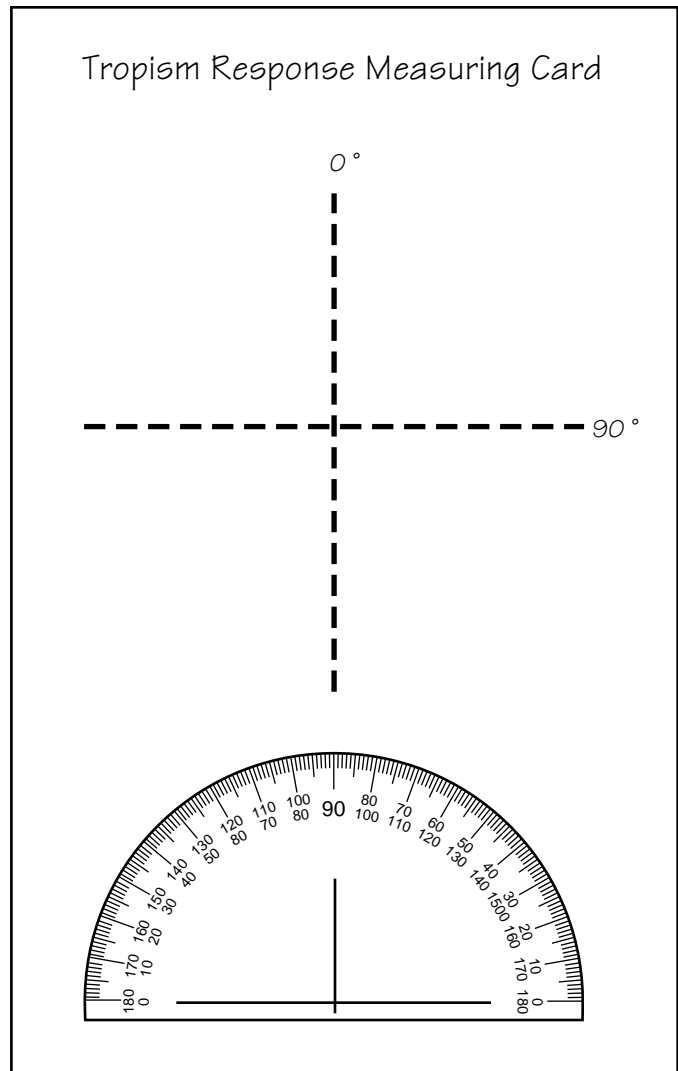

# Phototropism Data Sheet

Student Name 1 \_\_\_\_\_  
 Student Name 2 \_\_\_\_\_  
 Student Name 3 \_\_\_\_\_  
 Student Name 4 \_\_\_\_\_

## Environment

Temperature Range: \_\_\_\_\_ °C  
 Average Daily Temperature of Growing Environment: \_\_\_\_\_ °C

		Angle ( $\theta$ ) at Hour of Light Exposure																
Chamber Aperture #	Aperture Diameter (mm)	Area of Aperture (mm <sup>2</sup> )	T <sub>1</sub> _____ hr	T <sub>2</sub> _____ hr	T <sub>3</sub> _____ hr	T <sub>4</sub> _____ hr												
1	0	0																
2																		
3																		
4																		
ambient temperature during time period (°C):			hi	lo	avg	hi	lo	avg	hi	lo	avg	hi	lo	avg	hi	lo	avg	

# Mission Information\*

## Microgravity effects on pollination and fertilization

Experiment Acronym: B-STIC  
Principal Investigators: Dr. Mary Musgrave (United States) and Dr. Antonina Popova (Ukraine)  
Hardware: PGF

A particularly sensitive time in the life cycle of a plant growing in microgravity seems to be the transition from the vegetative to the reproductive phase. In previous spaceflight experiments, most plants grown full term in space failed to produce any seed at all, and in one experiment in which seeds were produced, the seed quality was very poor. Dosimetry readings taken in flight have failed to explain this ubiquitous sterility in terms of radiation load, thus some developmental failure during plant reproduction seems to be triggered by the microgravity environment itself. Reproductive events in angiosperms have a number of stages which could potentially be influenced directly by gravity. Microsporogenesis (the production of pollen), megasporogenesis (the production of egg cells), pollination and fertilization are all complex developmental events. *Brassica rapa*, a compact plant with a short life cycle, is ideal for such studies.

Close comparison of pollination and fertilization processes in microgravity with ground controls has not been possible before this experiment because we have not been able to control when pollination occurs. It is only through the availability of a trained participant for in-flight activities that controlled pollination and in-flight fixation of pollinated flowers will be possible. This will yield important information on pollen germination and maturation in microgravity, pollen-stigma interactions, pollen tube growth, fertilization and early embryo development.

Two plant populations are involved in this study. One population will be launched at the pre-flowering stage of growth. A second population will be seeds at time of launch. Using a pollination kit, the Payload Specialist will perform daily pollinations on the first population, and will mark the flowers pollinated with color-coded wire loops. The pollination wands will be stored with desiccant for subsequent viability assays on pollen. Several pollinated flowers will be fixed in-flight for microtubule studies, but the bulk of the flowers will be returned fresh for extensive processing on the ground. From the first population of plants which will be launched at the pre-flowering stage, siliques will be obtained. For high quality microscopy it will be necessary to dissect out the developing ovules prior to in-flight fixation. A small portion of the siliques will be placed in tissue culture for embryo rescue techniques.

From the second population of plants which were seeds at time of launch, flower buds will be obtained. In vivo tests on these buds will include pollen viability (fluorescein diacetate staining), pollen germination, pollen tube growth through the stigma (aniline blue staining), and staining for stigma esterases. Flower buds will be scored for size prior to dissection and processing for microscopy. In many ways, study of this single event in a plant life cycle integrates the many outstanding questions in gravitational biology.

\* adapted from CUE Experiment Requirements Document (ERD), draft version (6/13/96)



## PGF and PGC Schematics

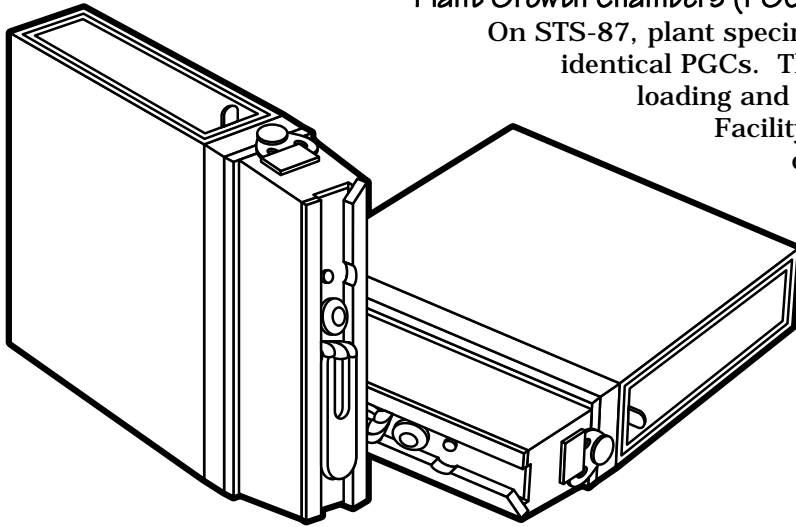

### Plant Growth Chambers (PGCs):

On STS-87, plant specimens will be contained in six identical PGCs. The PGCs are designed for easy loading and unloading into the Plant Growth Facility (PGF), and are designed to be doubled or possibly tripled in width.

Front Elevation of PGF:  
View of six Plant Growth Chambers (PGCs) and the Control Panel.

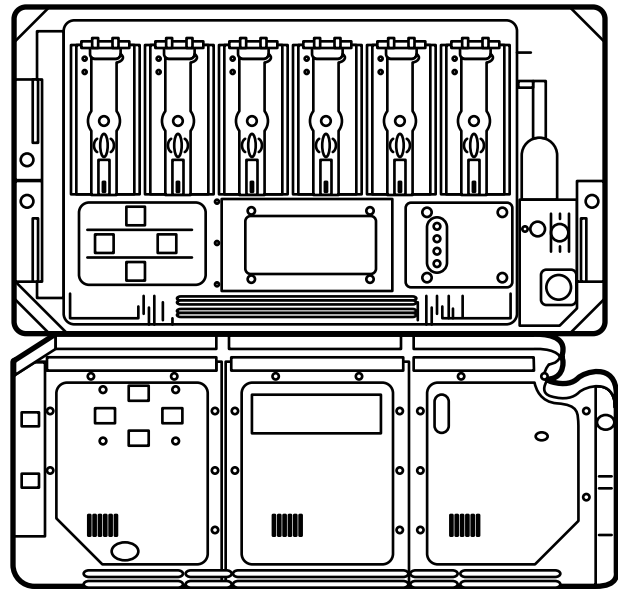

# Sources of Supplies

## *Acrylic Sheets*

The 2 mm thick, clear acrylic sheets of various size dimensions (e.g., 70 cm x 80 cm) are available from hardware and building supply stores.

## *AstroPlants Seed*

Seed from the stock of Wisconsin Fast Plants known as "AstroPlants" can be purchased from Carolina Biological Supply Company (2700 York Road, Burlington, NC 27215, tel: 800-334-5551).

## *Bees*

Honeybees can be obtained from local beekeepers, or commercially from Carolina Biological Supply Company (2700 York Road, Burlington, NC 27215, tel: 800-334-5551).

## *Capillary Wicking Material*

Capillary wicking material is used in the CUE-TSIPS peatlite growing system. Pellon is available from fabric stores. WaterMat® is available local garden supply centers or from Florist Products (2242 N. Palmer Drive, Schaumburg, IL 60173, tel: 1-800-828-2242).

## *Chemical Fixatives*

The components for mixing chemical fixative solutions are available from chemical supply companies; these components can be ordered for preparing solutions to fix brassica pods, embryos and ovules. A recipe for acetic alcohol fixative solution is included on page 98.

## *Drawer Organizers*

Drawer organizers can be purchased at discount houseware stores.

## *Nutrient Solution Chemicals*

The components for the Wisconsin Fast Plants nutrient solution can be ordered from commercial chemical supply companies. This solution is a modified Hoagland's basal salt mixture with the macro- and micronutrients as described by Hoagland and Arnon (1950). Hoagland's mixture is available premixed in volumes of 1 liter and 10 liters from Sigma Chemical Company (P.O. Box 14508, St. Louis, MO 63178, tel: 800-835-3010). A recipe for Wisconsin Fast Plants Nutrient Solution is included on page 96. Liquid fertilizers such as Peters® are available from garden supply stores.

## *Film Cans*

Both 35 mm black and clear film cans can be obtained in large quantities from film processing outlets or camera stores. The cans are usually discarded, so ask that they be saved.

## *Floral Foam*

Floral foam is available from florist supply stores.

## *Indicating Silica Gel*

Type III indicating silica gel changes color from blue to pink above 20% relative humidity. Silica gel is available in various quantities from Sigma Chemical Company (P.O. Box 14508, St. Louis, MO 63178, tel: 800-835-3010) and Aldrich Chemical Company (1001 West Saint Paul Avenue, Milwaukee, WI 53233, tel: 800-558-9160).

### *Iodine Potassium Iodide Staining Solution*

The components for the nutrient solution can be ordered from commercial chemical supply companies such as Sigma Chemical Company (P.O. Box 14508, St. Louis, MO 63178, tel: 800-835-3010). Directions for mixing the solution and staining specimens is included on page 98.

### *Lenses*

Double convex lenses for film can magnifiers are available from various suppliers, including Hamilton Bell (30 Craig Road, Montvale, NJ 07645, tel: 800-526-0864).

### *Light Banks*

Materials for constructing light banks are available from hardware and building supply stores, or a light system can be ordered from Carolina Biological Supply Company (2700 York Road, Burlington, NC 27215, tel: 800-334-5551).

### *Microscopes*

Illuminated hand-held microscopes are available in magnifications of 30X and 100X from local Radio Shack stores.

### *Mylar*

Colored mylar filters (for the phototropism activity) are available from entertainment or theatre supply stores or directly from Roscolux.

### *Peatlite*

Commercially available as JiffyMix<sup>®</sup> or Terra-lite Redi-earth<sup>®</sup>, peatlite mixtures can be obtained from garden supply stores.

### *Styrofoam Sheets*

Builder's insulating styrofoam can be purchased as large sheets from building supply stores.

**\* Note:** The listing of proprietary names in this section is not an endorsement of the products. The brand names listed are suggestions only.

## Wisconsin Fast Plants Nutrient Solution

Four stock solutions are made in 2-liter dispensing plastic soda bottles. Wisconsin Fast Plants Nutrient Solution is used in the reservoirs for continuous irrigation, mixed in the proportions listed. This nutrient solution is a modified half-strength (0.5X) Hoagland's solution. As an alternative to mixing the stock solutions and preparing the solution, premixed Hoagland's can be purchased from Sigma Chemical Company and diluted to half-strength for use in the CUE-TSIPS activities.

### Stock Solutions

- Stock Solution 1: Mixture
  - Add gram amounts to distilled water to make 1.8 liters of stock solution:
    - 1.0 M  $\text{KNO}_3$  (potassium nitrate) 182 grams
    - 0.2 M  $\text{KH}_2\text{PO}_4$  (potassium phosphate monobasic) 49 grams
    - 0.4 M  $\text{MgSO}_4 \cdot 7\text{H}_2\text{O}$  (magnesium sulfate) 177.5 grams (or 86.6 grams anhydrous)
- Stock Solution 2: Calcium Nitrate
  - Add gram amounts to distilled water to make 1.8 liters of stock solution:
    - 1.25 M  $\text{CaNO}_3$  (calcium nitrate) 531.4 grams
- Stock Solution 3: A-Z (micronutrients)
  - Add gram amounts to distilled water to make 100 ml, then put 45 ml solution in 2-liter bottle, fill to 1.8 liters using distilled water (discard excess):
    - $\text{H}_3\text{BO}_3$  (boric acid) 2.9 grams
    - $\text{MnCl}_2 \cdot 4\text{H}_2\text{O}$  (manganese chloride) 1.8 grams
    - $\text{ZnSO}_4 \cdot 7\text{H}_2\text{O}$  (zinc sulfate) 0.2 grams
    - $\text{CuSO}_4 \cdot 5\text{H}_2\text{O}$  (copper sulfate) 0.08 grams
    - $\text{H}_2\text{MoO}_4 \cdot \text{H}_2\text{O}$  (molybdic acid) 0.09 grams
- Stock Solution 4: Iron
  - Dissolve gram amounts in 400 ml of distilled water by heating to 80°C for one hour; let cool slightly and add distilled water to reach total volume of 1.8 liters:
    - $\text{FeSO}_4 \cdot 7\text{H}_2\text{O}$  (iron sulfate) 2.5 grams
    - Na EDTA (ethylene diamine tetraacetic acid) 3.3 grams

### Wisconsin Fast Plants Nutrient Solution

To make half-strength Wisconsin Fast Plants Nutrient Solution, mix the following quantities of the four stock solutions and add distilled water to make a total volume of one liter:

- 2.0 ml Mixture (Stock Solution 1)
- 2.5 ml Calcium Nitrate (Stock Solution 2)
- 2.0 ml A-Z (Stock Solution 3)
- 2.0 ml Iron (Stock Solution 4)

## Peters® Fertilizer Solution

Peters® Professional brand fertilizer solution (N-P-K 20-20-20, with minor elements) can be made in a dispensing plastic soda bottle. To mix the solution, dissolve one soda bottle cap of the Peters® crystals per liter of distilled water.

## Film Can Magnifier

A simple hand lens can open the world of micro-exploration for a student. Through the use of an inexpensive lens, a film can and soda bottle cap, students can make their own magnifier.

### Materials

- one clear film can (such as those made by Fuji®)
- one plastic soda bottle cap
- one double convex glass lens, 28 mm in diameter (**Tip:** Use a lens with a focal length of 59 mm; you can use smaller lenses but drill correspondingly smaller holes in the film can.)
- 17 to 20 mm diameter Pyrex test tube or wood bit with spurs
- propane torch or Bunsen burner

### Procedure

1. Drill or melt a 20 mm hole in a plastic soda bottle cap and in the bottom of a clear film can. To melt the hole, heat the lip of a Pyrex test tube in a propane torch or Bunsen burner flame. Carefully push the heated end of the tube through the cap and can.

**Caution:** Melting plastic can give off noxious fumes, perform this step in a well-ventilated area or under a hood.

2. Use scissors to trim off the small protruding rim of the cap so that it fits into the film can.
3. Drop the lens into the drilled film can. Push the drilled soda bottle cap into the can until it holds the lens snugly in place against the film can. The focal length of this lens will bring an object into focus at the open edge of the film can.

### Tips and Suggestions

- A local film processing outlet or camera store is a good source for film cans. Ask that the cans be saved for you, since they are usually discarded.
- You can thread a string through two small holes made in the film can and wear the magnifier as a necklace.
- The hand lens can be used as a bug bottle by placing a bug in the can and replacing the lid.

### For Dissections

- You can melt two larger holes in the side of the can to be used as access ports.

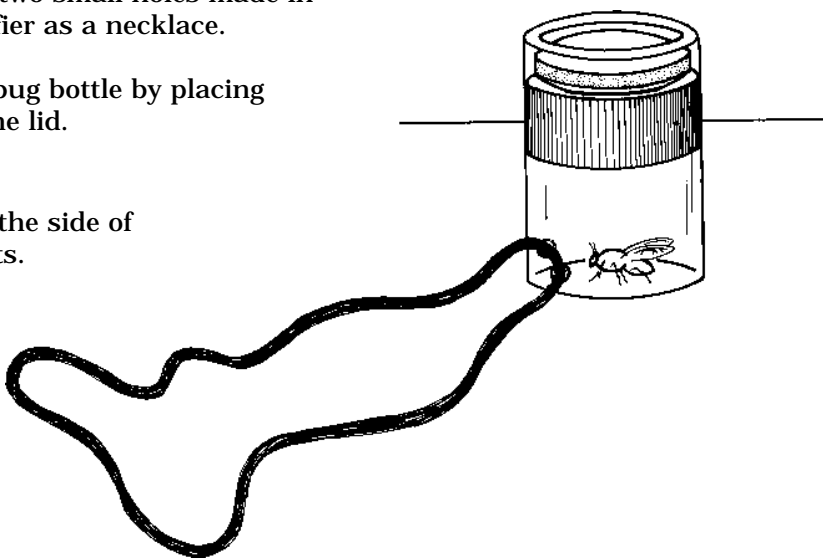

## Chemical Fixative

To mix a fixative solution, combine 75 ml 95% ethanol and 25 ml glacial acetic acid for a total volume of 100 milliliters

Store the fixative solution in an airtight container. Use caution when mixing chemicals.

At the desired developmental stages, remove pods from AstroPlants. Place the pods in an airtight container. Add a depth of the chemical fixative to cover the pods. Seal and label the container with the date and the age of the pods. Pods can be stored for many years at room temperature in acetic alcohol fixative.

Use forceps to remove pods from the fixative and transfer them into a container of at least 100 ml of water for at least three minutes. Pods can then be safely handled with fingers or forceps. Wash hands thoroughly after working with the fixed pods.

Acetic alcohol fixative solution can be poured down a sink and followed with water for disposal. Check with lab supervisors for any special instructions.

## Iodine Potassium Iodide (IKI) Staining Solution

To mix an iodine potassium iodide (IKI) staining solution, dissolve 2 g of KI in 100 ml distilled water. Then dissolve 0.2 g of iodine in the KI solution. Store the solution in an airtight container.

Starch will appear blue to black within a few minutes of staining. Newly formed starch may appear red to purple.

# Black Line Masters

## Dissection Card

Use this card for activities in which students make observations, drawings and measurements.

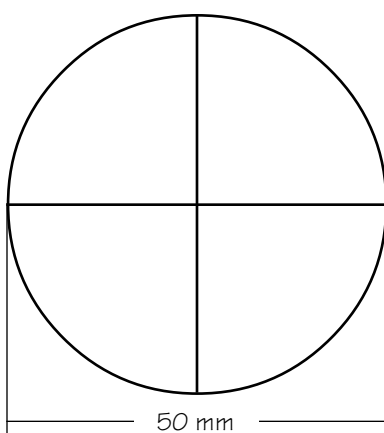
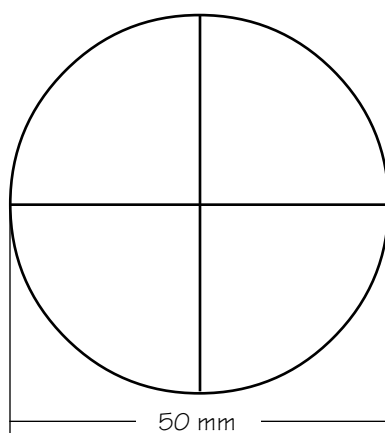
<b>Dissection Card</b>	
Name _____ Date _____	
<ol style="list-style-type: none"> <li>1. Draw a magnified scale on the horizontal axis of the field.</li> <li>2. Accurately draw scale bar indicating length.</li> <li>3. Draw the object in view to scale.</li> </ol>	<ol style="list-style-type: none"> <li>1. Draw a magnified scale on the horizontal axis of the field.</li> <li>2. Accurately draw scale bar indicating length.</li> <li>3. Draw the object in view to scale.</li> </ol>
Object is: _____	Object is: _____
	
<div style="border: 1px solid black; padding: 5px; margin-bottom: 5px;">complete items below:</div> magnification of lens: _____ X	<div style="border: 1px solid black; padding: 5px; margin-bottom: 5px;">complete items below:</div> magnification of lens: _____ X
length represented by scale bar: _____ mm	length represented by scale bar: _____ mm
actual length of scale bar: _____ mm	actual length of scale bar: _____ mm
estimated length of object: _____ mm	estimated length of object: _____ mm
calculated magnification of drawing: = _____ = _____ X	calculated magnification of drawing: = _____ = _____ X

# Dissection Strips

Photocopy this page onto an overhead transparency sheet. Stick the transparency sheet to a "do it yourself" laminating sheet or piece of clear contact paper, printed side down (this will protect the printing from being pulled off during use of the strip). Cut out the dissection strips. Use the strips for the activities in the pollination and fertilization sections.

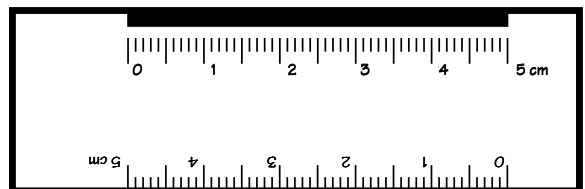
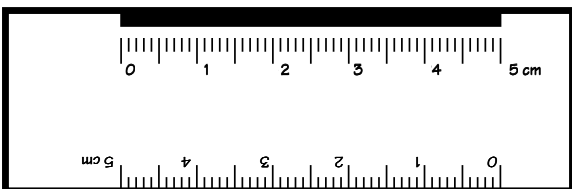
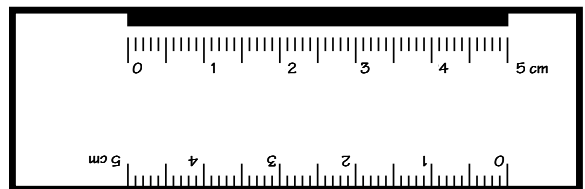
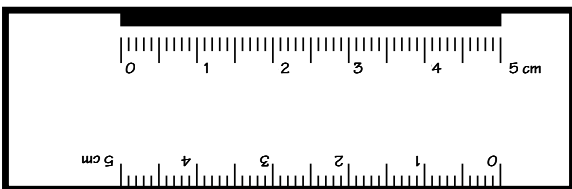
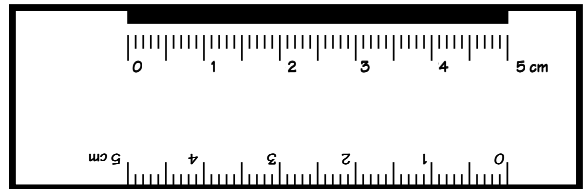
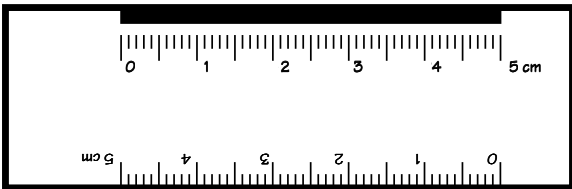
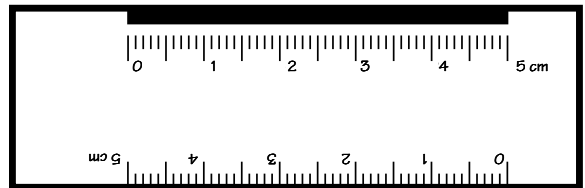
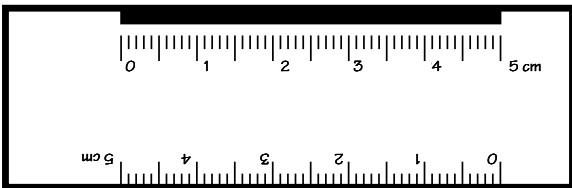
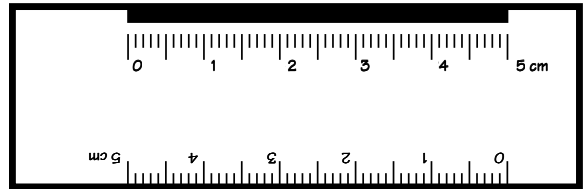
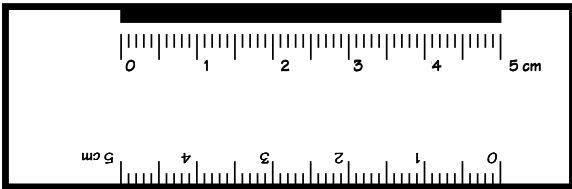
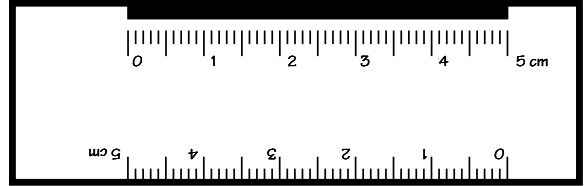
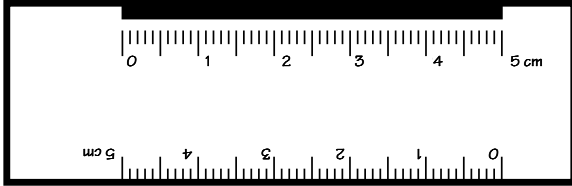



# NASA Space Life Sciences

## Suggested Resources for Study of Plants

### **Websites**

The following Internet addresses will provide users with links to the NASA Specialized Centers of Research and Training (NSCORTs) that focus on plant research and to NASA Life Sciences websites that include lessons and information on plants.

NSCORT in Gravitational Biology:

<http://www2.ncsu.edu/unity/lockers/project/ncsu-nsort/public/homepage.htm>

NSCORT in Plant Biology

Co-sponsored by NASA and the National Science Foundation

<http://trna.chem.yale.edu/pss/>

Plant Growth Imaging Homepage

<http://hideo.biosci.ohio-state.edu/>

NSCORT in Bioregenerative Life Support

<http://www.rci.rutgers.edu/~biorengg/njnsort>

Web of Life

This site is designed as an open door to activities of public interest sponsored by NASA's Life Sciences Division.

<http://webolife.arc.nasa.gov>

OR email to: [UL\\_outreach@mail.arc.nasa.gov](mailto:UL_outreach@mail.arc.nasa.gov)

NASA Headquarters Homepage

<http://www.hq.nasa.gov>

Office of Life and Microgravity Sciences and Applications Homepage

<http://www.hq.nasa.gov/office/olmsa>

Kennedy Space Center Homepage

<http://www.ksc.nasa.gov/ksc.html> - Select Biomedical Homepage, Select Space Biology

Johnson Space Center Homepage

<http://www/jsc.nasa.gov> - Select search, type word "plants"

Ames Research Center Advanced Life Support (CELSS)

<http://brad.arc.nasa.gov/Project/CELSSExplanation.html>

### **Additional Websites**

The AstroPlants

<http://fastplants.cals.wisc.edu/ap.html>

Wisconsin Fast Plants Information Documents

<http://fastplants.cals.wisc.edu>

## Books

- Bowman, J., Ed. 1994. *Arabidopsis, An Atlas of Morphology and Development*. Springer-Verlag, Inc. (New York).
- Buchmann, S.L. and G.P. Nabhan. 1996. *The Forgotten Pollinators*. Island Press (Covelo, CA).
- Darwin, C. 1880. *The Power of Movement in Plants*. J. Murray Publishing (London).
- Hart, J.W. 1990. *Plant Tropisms and Other Growth Movements*. Unwin Hyman Publishing (London).
- Kearns, C.A. and D.W. Inouye. 1993. *Techniques for Pollination Biologists*. Colorado University Press (Niewot, CO).
- National Council for Agricultural Education. 1994. *Using Fast Plants and Bottle Biology in the Classroom*. National Association of Biology Teachers (Reston, VA).
- Proctor, M., P. Yeo and A. Lack. 1996. *The Natural History of Pollination*. Harper Collins (London).
- Suge, Hiroshi. (editor) 1996. *Plants in Space Biology*. Institute of Genetic Ecology, Tohoku University.
- Ragnavan, V. 1986. *Embryogenesis in Angiosperms: A Developmental and Experimental Study*. Cambridge University Press (New York).
- Raven, P.H., R.F. Evert and S.E. Eichorn. 1992. *Biology of Plants*. Worth Publishers (New York).
- Vogt, G.L. and J.J. Wargo, Eds. 1992. *Microgravity*. National Aeronautics and Space Administration (Washington, D.C.).

## Journal Articles

- Evans, M.L., Moore, R., Hasenstein, K.H., 1986 How roots respond to gravity. *Scientific American* 254: 112–119.
- Reiser, L. and R. Fischer. 1993. The ovule and embryo sac. *The Plant Cell* 5:1291–1301.
- Russel, S. 1993. The egg cell: development and role in fertilization and early embryogenesis. *The Plant Cell* 5:1349–1359.
- Salisbury, F.B. 1993. Gravitropism: Changing Ideas. In *Offprints from Horticultural Reviews, Volume 15*, pp. 233–278.
- Salisbury, F.B. and B.G. Bugbee. 1988. Space farming in the 21st Century. *21st Century Science and Technology* 1:32–41.
- West, M. and J. Harada. 1993. Embryogenesis in higher plants: an overview. *The Plant Cell* 5:1361–1369.
- Williams, P.H. 1986. Rapid-cycling populations of Brassica. *Science* 232:1385–1389.
- Yeung, E. and D. Meinke. 1993. Embryogenesis in angiosperms: development of the suspensor. *The Plant Cell* 5:1371–1381.

### **Wisconsin Fast Plants Information Documents**

(Documents available from the Wisconsin Fast Plants office or at <http://fastplants.cals.wisc.edu>.)

**Wisconsin Fast Plants. 1987. "Around the World with Brassicas" Wisconsin Fast Plants (Madison, WI).**

**Wisconsin Fast Plants. 1994. "Hormone-Induced Parthenocarpy in Rapid-Cycling Brassica Rapa." Wisconsin Fast Plants (Madison, WI).**

**Wisconsin Fast Plants. 1996a. "The Hunt for Glucose—A Flower's Treasure." Wisconsin Fast Plants (Madison, WI).**

**Wisconsin Fast Plants. 1990. "Pollen Germination." Wisconsin Fast Plants (Madison, WI).**

**Wisconsin Fast Plants. 1996b. "Pollen-Stigma Interactions and Pollen Tube Growth." Wisconsin Fast Plants (Madison, WI).**

# NASA Educational Resources

**NASA On-line Resources for Educators** provide current educational information and instructional resource materials to teachers, faculty, and students. A wide range of information is available, including science, mathematics, engineering, and technology education lesson plans, historical information related to the aeronautics and space program, current status reports on NASA projects, news releases, information on NASA educational programs, useful software and graphics files. Educators and students can also use NASA resources as learning tools to explore the Internet, accessing information about educational grants, interacting with other schools which are already on-line, and participating in on-line interactive projects, communicating with NASA scientists, engineers, and other team members to experience the excitement of real NASA projects.

Go to these resources through the NASA Education Home Page:  
<http://www.hq.nasa.gov/office/codef/education>

or, for more information, E-mail:  
[comments@spacelink.msfc.nasa.gov](mailto:comments@spacelink.msfc.nasa.gov)

**NASA Television (NTV)** is the Agency's distribution system for live and taped programs. It offers the public a front-row seat for launches and missions, as well as informational and educational programming, historical documentaries, and updates on the latest developments in aeronautics and space science. NTV is transmitted on Spacenet 2 (a C-band satellite) on transponder 5, channel 9, 69 degrees west with horizontal polarization, frequency 3880 megahertz, audio on 6.8 megahertz; or through collaborating distance learning networks and local cable providers.

Apart from live mission coverage, regular NASA Television programming includes a News Video File from noon to 1:00 pm, a NASA History File from 1:00 to 2:00 pm, and an Education File from 2:00 to 3:00 pm (all times Eastern). This sequence is repeated at 3:00 pm, 6:00 pm, and 9:00 pm, Monday through Friday. The NTV Education File features programming for teachers and students on science, mathematics, and technology, including the *NASA... On the Cutting Edge* Education Satellite Videoconference Series. The videoconferences include NASA scientists, astronauts, and education specialists presenting aeronautics and Earth & space science topics of interest to teachers and students of grades 5-12. The series is free to registered educational institutions. The videoconferences and all NASA Television programming may be videotaped for later use.

For more information on NASA Television, contact:  
NASA Headquarters, Code P-2, NASA TV, Washington, DC 20546-0001  
Phone: (202) 358-3572  
Home Page: <http://www.hq.nasa.gov/office/pao/ntv.html>

For more information about the Education Satellite Videoconference Series, contact: Videoconference Producer, NASA Teaching From Space Program, 308 CITD, Room A, Oklahoma State University, Stillwater, OK 74078-8089  
E-mail: [edge@aesp.nasa.okstate.edu](mailto:edge@aesp.nasa.okstate.edu)  
Home Page: <http://www.okstate.edu/aesp/VC.html>

# NASA Educator Resource Center Network

To make additional information available to the education community, the NASA Education Division has created the NASA Educator Resource Center (ERC) network. ERCs contain a wealth of information for educators: publications, reference books, slide sets, audio cassettes, videotapes, telelecture programs, computer programs, lesson plans, and teacher guides with activities. Because each NASA field center has its own areas of expertise, no two ERCs are exactly alike. Phone calls are welcome if you are unable to visit the ERC that serves your geographic area. A list of the centers and the geographic regions they serve starts at the bottom of this page.

*Regional Educator Resource Centers (RERCs)* offer more educators access to NASA educational materials. NASA has formed partnerships with universities, museums, and other educational institutions to serve as RERCs in many states. Educators may preview, copy, or receive NASA materials at these sites. A complete list of RERCs is available through CORE.

*NASA Central Operation of Resources for Educators (CORE)* was established for the national and international distribution of NASA-produced educational materials in audiovisual format. Educators can obtain a catalogue and an order form by one of the following methods:

- **NASA CORE**  
Lorain County Joint Vocational School  
15181 Route 58 South  
Oberlin, OH 44074
- Phone (216) 774-1051, Ext. 249 or 293
- Fax (216) 774-2144
- E-mail: [nasaco@leeca8.leeca.ohio.gov](mailto:nasaco@leeca8.leeca.ohio.gov)
- Home Page: <http://spacelink.msfc.nasa.gov/CORE>



**IF YOU LIVE IN:**

**Precollege Officer**

**Educator Resource Center**

Alaska	Nevada	Mr. Garth A. Hull	NASA Educator Resource Center
Arizona	Oregon	Chief, Educational Programs Branch	Mail Stop 253-2
California	Utah	Mail Stop 204-12	NASA Ames Research Center
Hawaii	Washington	<b>NASA Ames Research Center</b>	Moffett Field, CA 94035-1000
Idaho	Wyoming	Moffett Field, CA 94035-1000	Phone: (415) 604-3574
Montana		Phone: (415) 604-5543	
Connecticut	New Hampshire	Dr. Robert Gabrys	NASA Educator Resource Laboratory
Delaware	New Jersey	Chief, Education Office	Mail Code 130.3
District of Columbia	New York	Mail Code 130.3	NASA Goddard Space Flight Center
Maine	Pennsylvania	<b>NASA Goddard Space Flight Center</b>	Greenbelt, MD 20771-0001
Maryland	Rhode Island	Greenbelt, MD 20771-0001	Phone: (301) 286-8570
Massachusetts	Vermont	Phone: (301) 286-7206	
Colorado	North Dakota	Ms. Billie A. Deason	NASA Educator Resource Room
Kansas	Oklahoma	Education Team Lead	Mail Code AP 2
Nebraska	South Dakota	Education & Information Services Branch - AP 2	NASA Johnson Space Center
New Mexico	Texas	<b>NASA Johnson Space Center</b>	2101 NASA Road 1
		2101 NASA Road 1	Houston, TX 77058-3696
		Houston, TX 77058-3696	Phone: (281) 483-8696
		Phone: (281) 483-2462	

**IF YOU LIVE IN:****Precollege Officer****Educator Resource Center**

Florida  
 Georgia  
 Puerto Rico  
 Virgin Islands

Dr. Steve Dutczak  
 Chief, Education and Services Branch  
 Mail Code PA-ESB  
**NASA Kennedy Space Center**  
 Kennedy Space Center, FL 32899-0001  
 Phone: (407) 867-4444

NASA Educator Resource Laboratory  
 Mail Code ERL  
 NASA Kennedy Space Center  
 Kennedy Space Center, FL 32899-0001  
 Phone: (407) 867-4090

Kentucky  
 North Carolina  
 South Carolina  
 Virginia  
 West Virginia

Dr. Marchelle Canright  
 Precollege Officer  
 Mail Stop 400  
**NASA Langley Research Center**  
 17 Langley Boulevard  
 Hampton, VA 23681-0001  
 Phone: (757) 864-3313

NASA Educator Resource Center  
 for Langley Research Center  
 Virginia Air and Space Center  
 600 Settler's Landing Road  
 Hampton, VA 23669-4033  
 Phone: (757) 727-0900 x 757

Illinois  
 Indiana  
 Michigan

Minnesota  
 Ohio  
 Wisconsin

Ms. Jo Ann Charleston  
 Acting Chief, Office of Educational Programs  
 Mail Stop 7-4  
**NASA Lewis Research Center**  
 21000 Brookpark Road  
 Cleveland, OH 44135-3191  
 Phone: (216) 433-2957

NASA Educator Resource Center  
 Mail Stop 8-1  
 NASA Lewis Research Center  
 21000 Brookpark Road  
 Cleveland, OH 44135-3191  
 Phone: (216) 433-2017

Alabama  
 Arkansas  
 Iowa

Louisiana  
 Missouri  
 Tennessee

Mr. William Anderson  
 Director, Education Programs Office  
 Mail Code CL01  
**NASA Marshall Space Flight Center**  
 Huntsville, AL 35812-0001  
 Phone: (205) 544-8811

NASA Educator Resource Center  
 for Marshall Space Flight Center  
 U.S. Space and Rocket Center  
 P.O. Box 070015  
 Huntsville, AL 35807-7015  
 Phone: (205) 544-5812

Mississippi

Dr. David Powe  
 Manager, Educational Programs  
**NASA John C. Stennis Space Center**  
 P.O. Box 508  
 Iuka, MS 38852-0508  
 Phone: (601) 423-7452

NASA Educator Resource Center  
 Building 1200  
 NASA John C. Stennis Space Center  
 Stennis Space Center, MS 39529-6000  
 Phone: (601) 688-3338

Mr. David Seidel  
 Precollege Officer  
 Mail Stop CS-530  
**NASA Jet Propulsion Laboratory**  
 4800 Oak Grove Drive  
 Pasadena, CA 91109-8099  
 Phone: (818) 354-6916

NASA Educator Resource Center  
 Mail Stop CS-530  
 NASA Jet Propulsion Laboratory  
 4800 Oak Grove Drive  
 Pasadena, CA 91109-8099  
 Phone: (818) 354-6916

California (mainly cities near  
 Dryden Flight Research Facility)

Dr. Marianne McCarthy  
 Education Specialist  
 P.O. Box 273, MS D4839A  
**NASA Dryden Flight Research Facility**  
 Edwards, CA 93523-0273  
 Phone: (805) 258-2281

NASA Educator Resource Center for  
 NASA Dryden Flight Research Facility  
 45108 N. 3rd. Street East  
 Lancaster, CA 93535  
 Phone: (805) 948-7347

Virginia and Maryland's  
 Eastern Shores

Mr. Keith Koehler  
 Public Affairs Specialist  
**Wallops Flight Facility**  
 Wallops Island, VA 23337  
 Phone: (804) 824-1597

NASA Goddard Space Flight Center  
 Wallops Flight Facility  
 Education Complex/Visitor Center Bldg. J-17  
 Wallops Island, VA 23337-5099  
 Phone: (804) 824-2297 / 2298

# TEACHER REPLY CARD

## Teachers and Students Investigating Plants in Space: A Teacher's Guide with Activities for Life Sciences

To achieve America's goals in Educational Excellence, it is NASA's mission to develop supplementary instructional materials and curricula in science, mathematics, and technology. NASA seeks to involve the educational community in the development and improvement of these materials. Your evaluation and suggestions are vital to continually improving NASA educational materials.

**Please take a moment** to respond to the statements and questions below. You can submit your response through the Internet or by mail. Send your reply to the following Internet address:

[http://ednet.gsfc.nasa.gov/edcats/teacher\\_guide](http://ednet.gsfc.nasa.gov/edcats/teacher_guide)

You will then be asked to enter the publication number, you will see this form generated electronically on your screen. Enter your data at the appropriate prompt.

Otherwise, fold the mailer in half, tape it shut, affix proper postage, and return the reply card by mail. Thank you.

1. With what grades did you use the teacher guide and activities?

Number of **Teachers/Faculty**:  
 \_\_\_ K-4 \_\_\_ 5-8 \_\_\_ 9-12 \_\_\_ Community College \_\_\_ College/University  
 \_\_\_ Graduate \_\_\_ Undergraduate

Number of **Students**:

\_\_\_ K-4 \_\_\_ 5-8 \_\_\_ 9-12 \_\_\_ Community College \_\_\_ College/University  
 \_\_\_ Graduate \_\_\_ Undergraduate

Number of **Others**:

\_\_\_ Administrators/Staff \_\_\_ Parents \_\_\_ Professional Groups \_\_\_ Civic Groups  
 \_\_\_ General Public \_\_\_ Other

2. What is your 9-digit zip code? \_\_\_\_\_

3. How was the quality of this teacher's guide?

Excellent  Good  Average  Poor  Very Poor

4. How did you use this teacher's guide?

- |  |   |
|--|---|
| <input type="checkbox"/> Background Information              | <input type="checkbox"/> Critical Thinking Tasks    |
| <input type="checkbox"/> Demonstrate NASA Materials          | <input type="checkbox"/> Demonstration              |
| <input type="checkbox"/> Group Discussions                   | <input type="checkbox"/> Hands-On Activities        |
| <input type="checkbox"/> Integration Into Existing Curricula | <input type="checkbox"/> Interdisciplinary Activity |
| <input type="checkbox"/> Lecture                             | <input type="checkbox"/> Science and Mathematics    |
| <input type="checkbox"/> Team Activities                     | <input type="checkbox"/> Standards Integration      |

Other: Please specify:

5. What features of this guide did you find particularly helpful?

\_\_\_\_\_  
 \_\_\_\_\_  
 \_\_\_\_\_  
 \_\_\_\_\_

6. How can we make this guide more effective for you?

\_\_\_\_\_  
 \_\_\_\_\_  
 \_\_\_\_\_  
 \_\_\_\_\_

7. Additional comments:

\_\_\_\_\_  
 \_\_\_\_\_  
 \_\_\_\_\_

Fold along line, and tape closed.

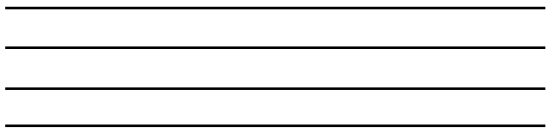

PLEASE PLACE  
STAMP HERE  
POST OFFICE WILL  
NOT DELIVER  
WITHOUT PROPER  
POSTAGE

**NATIONAL AERONAUTICS AND SPACE ADMINISTRATION  
EDUCATION DIVISION  
MAIL CODE FE  
WASHINGTON DC 20546-0001**

